

# TEM 2020



On | Off and everything in between





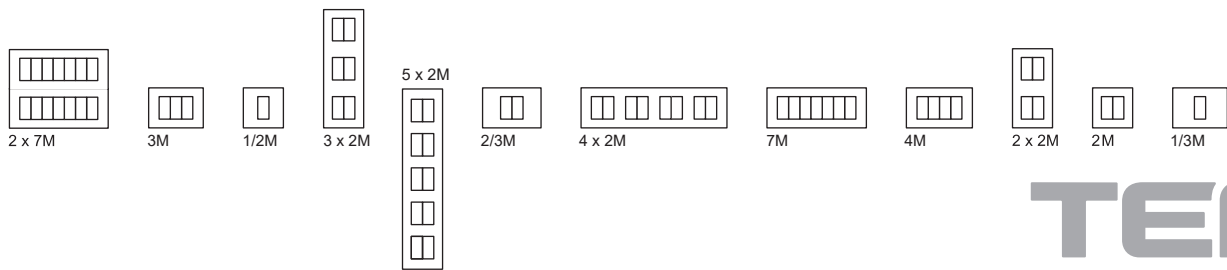

TEM

# Dobrodošli v družini MODUL

Welcome to the MODUL family

Za vas dopolnjujemo in izpopolnjujemo sodobno družino stikal Modul za vse vrste vaših prostorov.

We are expanding and perfecting the modern Modul switch family for all types of rooms.



discovering new insights

odkrivamo nove poglede

# MODUL

Oblikovne linije Pure, Line in Soft so odraz sodobnega, prefinjenega in individualnega življenjskega stila. Iz široke in bogate palete barv, vzorcev in oblik lahko svoja stikala in vtičnice kadarkoli preprosto prilagodite zelenemu ambientu in razpoloženju.

The Pure, Line and Soft design lines reflect a modern, sophisticated and independent lifestyle. You can choose from a wide and rich selection of colours, patterns and shapes to alter the appearance of your switches and sockets so that they fit the desired atmosphere and mood.

PURE

naravni materiali  
natural materials

les  
kovina  
steklo

wood  
metal  
glass

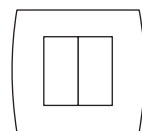



—line—



ravne linije  
straight lines

—soft—



mehke linije  
soft lines

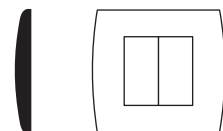
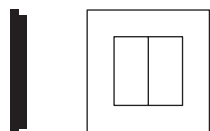

# PURE



## čudovito bivanje wonderful living

Iz čistih, neomadeževanih podob na novo rojenega sveta je vzklila zgodba Pure. Dotik naravnih motivov smo preplekli s prefinjenim okusom za linije in obliko ter vtkali niti vrhunske tehnologije.

From the cleanliness and purity of a new-born world stems the story of the Pure line. The touch of natural motifs is intertwined with a sophisticated taste for lines and form and interwoven with threads of state-of-the-art technology.







# PURE

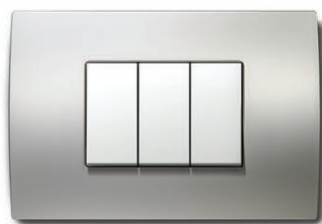





## občutek narave feeling of nature

Linijo stikal Pure odlikujejo naravni materiali: kovina, les, steklo. Poseben dotik se izraža skozi edinstveno obliko. Je opazen, a hkrati nevsiljiv. Izžareva čutnost, prefinjenost, merila visokega standarda in seveda čistost.

The Pure switch line is distinguished by its natural materials: metal, wood and glass. Its unique design gives it a special touch. It is striking yet unobtrusive. It radiates sensuality, sophistication, high standards and, of course, cleanliness.

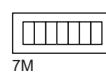
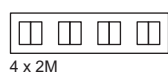

line



## harmonija ravnih oblik harmony of straight lines

Pripravite se na elegantno popolnost ravnih oblik. Preizkusite sijajnost površin, ki se nežno poigravajo z modernimi elementi vašega prostora. Posebej za vas smo vgradili tehnologijo Soft Touch, da je vsak vaš dotik posebno doživetje.

Prepare for the elegant perfection of straight shapes. Try brilliant surfaces that gently play with modern elements of your room. We have incorporated "Soft Touch" technology especially for you, turning every touch into a unique experience.





line

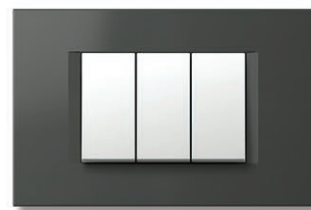
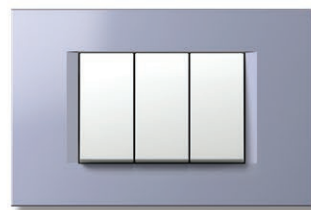
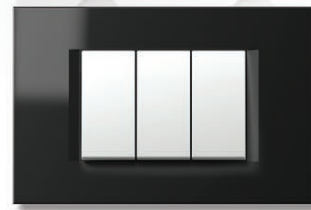
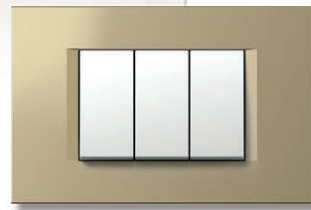
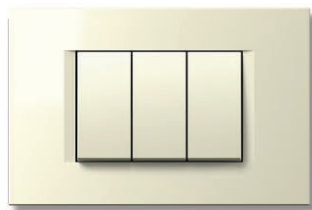
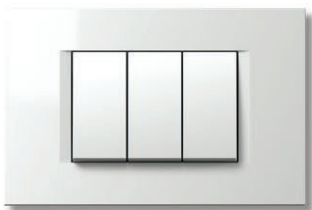
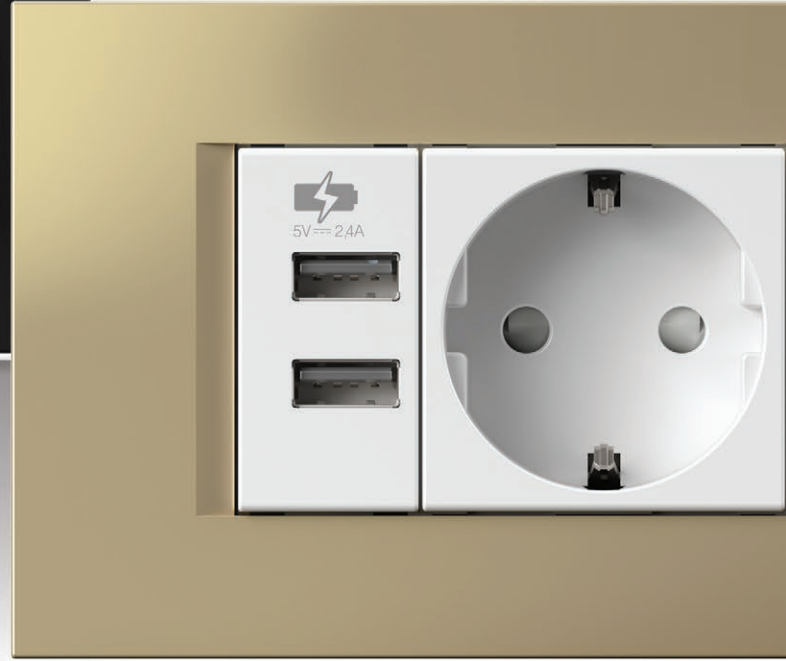

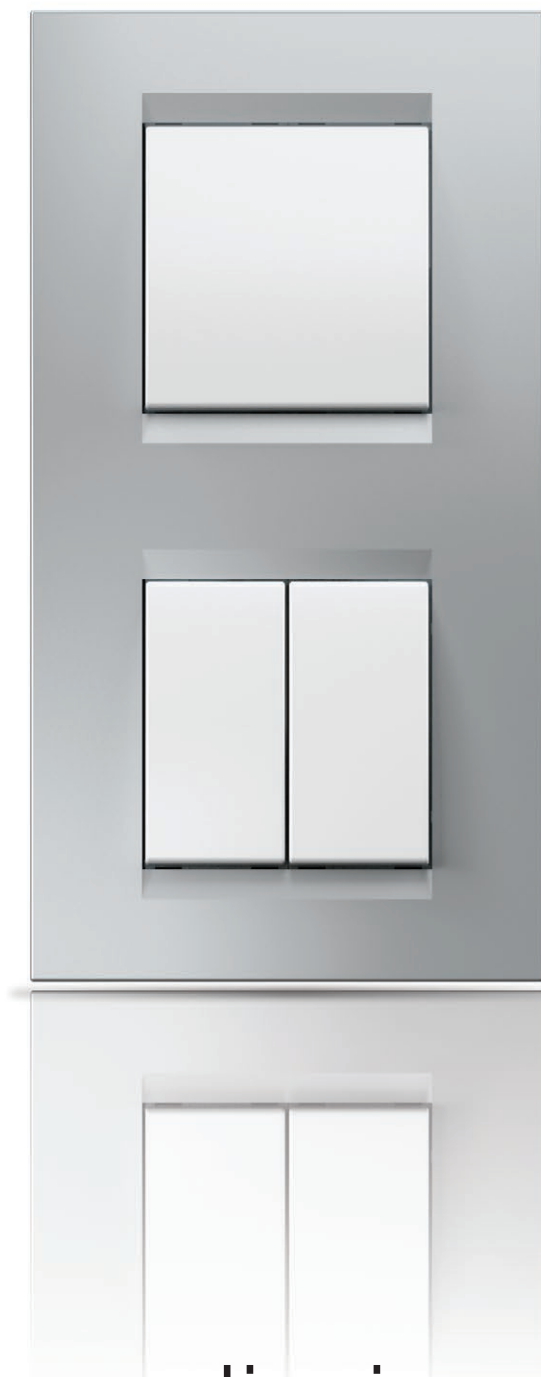

## sodoben dizajn modern design

Čiste, ravne linije ustvarjajo brezčasen dizajn.  
Popoln, ravno oblikovan tanek profil in ergonomija  
mehkega dotika dajeta vrhunski videz z vseh strani.

Its straight, smooth lines make for a timeless design.  
Its perfectly straight, sleek profile and soft-touch ergonomics  
give it an amazingly elegant appearance from all angles.

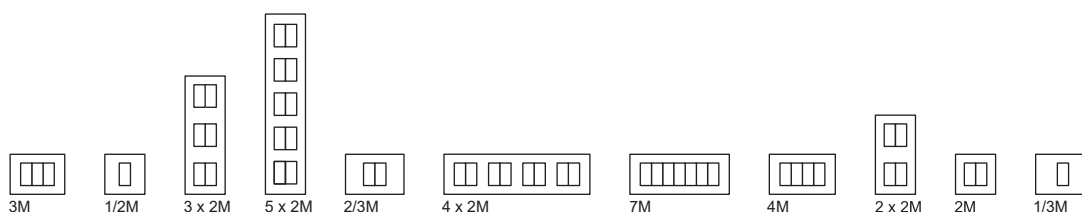



soft



# mehkoba v vašem domu

## softness in your home

Dovolite, da zaobljene oblike in nežni prehodi  
prinesejo mehko v vaš dom.

Let the rounded shapes and soft transitions  
bring softness into your home.



soft

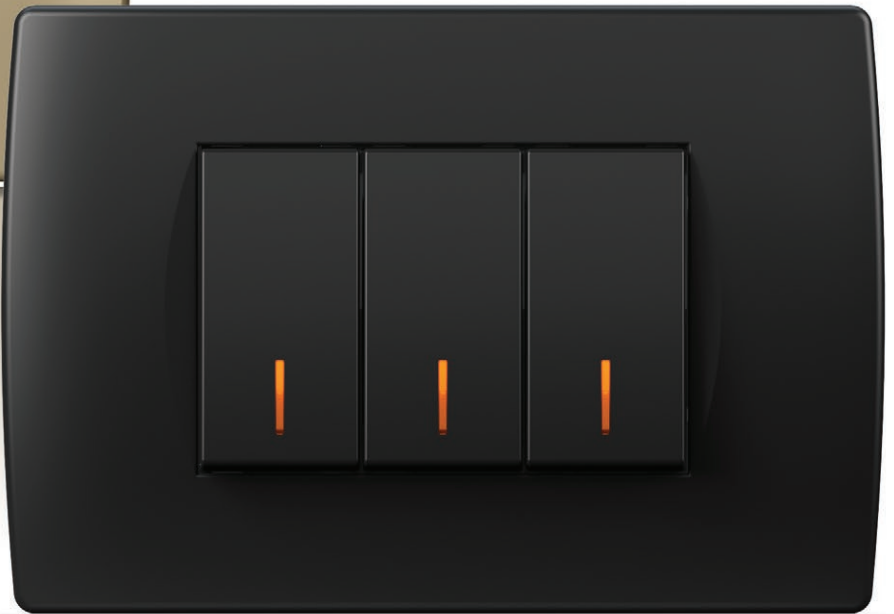





# toplina doma a warm home

Popolnost mehke oblike smo nadgradili s subtilnim izborom barv in posebnimi nanosi, ki jih čutite ob dotiku.

Perfectly soft shapes rounded off by a subtle selection of colours and special coatings for a special touch.

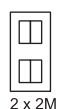
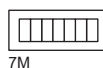
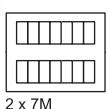



# antracit

## anthracite

Dodajamo dve barvni izkušnji – ANTRACIT in TITAN. Obe zadovoljita vaš prefinjen čut za estetiko in dopolnita detajle prostorov po vaši meri. Kot naročeni lahko v harmoniji nadgradita vaše sodobno trendovsko stanovanje.

We are adding two colour experiences to our range – ANTHRACITE and TITANIUM. They both satisfy our customer's sophisticated sense of style and complement the details of spaces according to their wishes. Now you can upgrade your modern apartment in harmony.



# trend barve

trendy colours



titan  
titanium



# multiuporabnost

## multifunctionality



## estetika

### aesthetics

Pripravili smo vam večje okvirje, ki omogočajo upravljanje več funkcij z enega mesta. Na voljo so v družinah LINE, SOFT in PURE. Pri naravnih materialih okvirjev se ta repeticija še toliko bolj izraža na visokem estetskem nivoju.

We have created larger cover plates for you that allow you to manage multiple functions from one spot. They are available in the LINE, SOFT and PURE design ranges. The cover plates, which are made from natural materials, utilise the repetition of design elements to elevate them to a high aesthetic level.





# univerzalni zatemnilnik

## universal dimmer

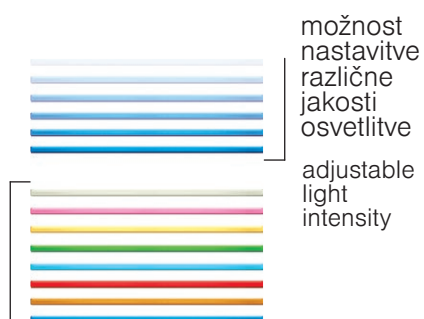
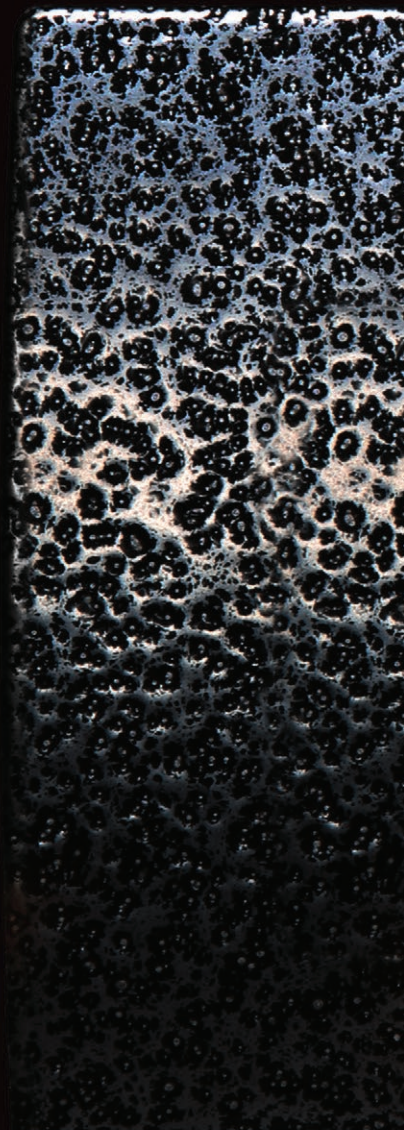

možnost  
nastavitve  
različne  
jakosti  
osvetlitve

adjustable  
light  
intensity

možnost  
izbire  
različnih  
barv  
osvetlitve  
choosing  
illumination  
colour

V temi postane Touch nežna, ambientalna lučka, ki označuje mesto stikala in blago razsvetljuje prostor. Izberete lahko eno od osmih različnih barv nežne svetlobe, katerih svetlost lahko kadarkoli poljubno prilagodite svojemu razpoloženju.

In the dark Touch becomes a tender soft ambient light. It marks the spot of a switch and gently illuminates a place. You can choose among eight different colours of tender light and adapt its brightness according to your mood.



TOUCH®



# svetloba, kot še nikoli

## light as never seen before

Pridušena svetloba ustvarja ozračje miru, pa tudi čutnosti in romantike. Je zaščitni znak romantičnih lokalov in mirnih poznovečernih ur doma ali v delovnem prostoru. Mehak, podaljšan vklop ne podaljšuje le življenjske dobe sijalke, ampak tudi veliko prijazneje in počasneje zamenja temo s svetlobo. Touch omogoča, da zatemnite svetlobo kjerkoli, ne glede na tip sijalke ali žarnice.

A dimmed light makes peaceful, sensual and romantic atmosphere. It is a trade mark of romantic places and quiet late evening hours spent at home or at work. Switching is soft and extended. It does not only prolong the lamp life expectancy, but also changes darkness into light in a slower and much more pleasant way. Touch enables you to dim the light anywhere, regardless of the type of lamps.





## vse na enem mestu

everything in one place

Vaša hiša je postala središče življenja. Množica vseh naprav zahteva številne priključke in vtičnice. Sestavite si svoj multimedijski center, ki vam nudi možnost priključitve in upravljanja več različnih komponent na enem mestu.

Your house is the centre of your life. The multitude of devices you use requires a number of connectors and sockets. Create your own multimedia centre, one that will allow you to connect and use a multiple number of different components in one place.





# inovativen krmilnik temperature

## innovative temperature controller

Poskrbite za svoje udobje in s pametnim termostatom upravljajte temperaturo bivalnih in delovnih prostorov v vseh letnih časih. Upravljate lahko naprave grelja in hlajenja z možnostjo ekonomičnega delovanja.

Make yourself comfortable by controlling the temperature in your living and working rooms during all seasons with a smart thermostat. It allows you to control heating and cooling devices and features an eco-function.

# udobje prostora

comfort in your room



udobje uporabe  
convenience of use



## TOUCHLESS-brez dotika

Brezdotično stikalo vam omogoča sodoben način življenja, saj svetila lahko prižigate in ugašate, ne da bi se dotaknili stikala. Ta možnost je zelo uporabna, če imate polne ali umazane roke, saj lahko luč prižgete brez dotika.

The touchless switch allows you to enjoy a modern lifestyle, enabling the turning on and off of your lights, without the need for physical interaction. This option is very useful when you find yourself with your hands full, or dirty, as you can achieve the desired lighting without undue fuss.





# sodobna osvetlitev

modern illumination





# 3D svetilka

## 3D lamp

Hiter tempo življenja prinaša množico informacij. 3D barvna svetilka je elegantna rešitev za označevanje, usmerjanje in sporočanje. Grafiko izdelamo po vaši želji.

The rapid pace of life means you are constantly being bombarded with a plenty of information. 3D colour lamp provide an elegant solution for information and direction signs. We can make graphics according to your wishes.





# BIOPASS - odklepanje brez ključev

## BIOPASS – keyless unlocking

BIOPASS je nova generacija stikala za odklepanje brez ključev. Združuje napredno tehnologijo prepoznavanja prstnih odtisov in hitrega odpiranja vhodnih vrat.

Samo položite svoj prst na stikalo Biopass in vrata vašega doma ali pisarne se bodo odprla. Tako enostavno in tako zelo varno. Upravljate ga enostavno prek mobilne aplikacije.

BIOPASS is the new generation of switches for keyless unlocking. It combines advanced fingerprint recognition technology with quick front door opening.

Simply put your finger on the Biopass switch and the doors to your home or office will open. It is so easy to use and incredibly secure. You can manage it effortlessly via the mobile app.

povečana varnost  
improved security



# individualnost

## individuality



## naredite si svojega

### make it your own

Bodite drugačni. Zaželite si stikala po vaši meri. Izbirajte med različnimi barvami okvirjev, lahko vam jih okrasimo s poljubnimi grafikami in napisi. Izberite barvo osvetlitve, ki ustreza vašemu ambientu.

Be different. Make a switch according to your taste. You can choose between different frame colours and we can decorate them for you with custom graphics or signs. Choose a illumination colour that suits the ambience of your room.





primerno za javno uporabo  
suitable for public use



## kakovost in trpežnost quality and durability

Kakovostni in trpežni materiali zagotavljajo dolgo življenjsko dobo modularnih stikal in vtičnic MODUL. Sistem je zato primeren za vgradnjo in brezskrbno uporabo v javnih ustanovah, poslovnih zgradbah, turističnih nastanitvah, trgovskih centrih, šolah in športnih objektih. Prilagodi se tako sodobni arhitekturi kot klasičnim interierjem.

Quality and durable materials ensure the long lifetime of the MODUL modular switches and sockets. The system is suitable for mounting and carefree use in public facilities, business premises, tourist accommodation, shopping centres, schools and sports facilities. It fits perfectly in both modern architecture and classical interiors.







## zmogljivi USB polnilniki powerful USB chargers

Z zmogljivimi USB polnilniki Modul boste hitro in enostavno napolnili pametne telefone, tablične računalnike in ostale e-naprave prek standardnega USB priključka. Na voljo so v velikostih 1M in 2M. Idealni so tako za uporabo v zasebnih kot javnih prostorih.

The powerful Modul USB chargers enable the fast and simple charging of your smartphones, tablets and other electronic devices via a standard USB connection. They are available in 1M and 2M sizes and are perfect for use in private and public rooms.

# hitro polnjenje

fast charging



# sodobno delovno okolje a modern working environment







## estetski aluminijasti kanali aesthetic aluminium trunkings

Poskrbite za urejenost pisarniških, šolskih in delovnih prostorov. Znebite se vidnih kablov in nerodnih podaljškov. Elegantni aluminijasti kanali modernega videza nudijo veliko prostora za elektroinštalacije. Stikala, vtičnice in komunikacijski priključki so hitro dostopni in na voljo tam, kjer jih potrebujete. Enostavno jih lahko spremenite ali naknadno dodate nove. Ustvarite si prijetno funkcionalno okolje.

Organise your office, school and work areas. Forget visible cables and unpractical extensions. The elegant and modern aluminium trunkings offer plenty of space for electrical installations. Switches, sockets and communication elements are easily accessible and available in the right place to be used. They can be easily adapted or upgraded. Arrange a pleasant and functional environment for yourself.

# modularnost

## modularity

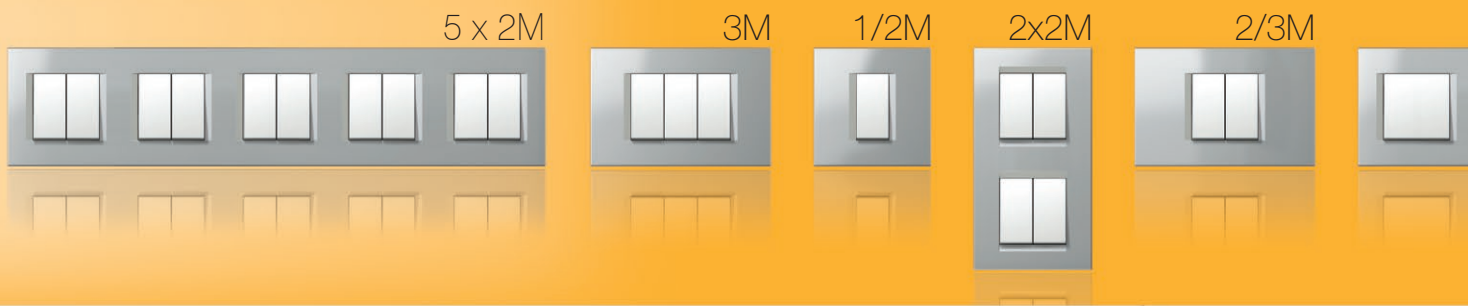

Poskrbeli smo za celovit sistem. V njem najdete vse elemente za poljuben sestav. Osnovni elementi sistema so moduli. Kombinirate jih lahko vodoravno ali navpično.

We have designed a comprehensive system that features a variety of elements, allowing you to create any configuration you wish. The basic elements of the system are modular and can be combined horizontally or vertically.



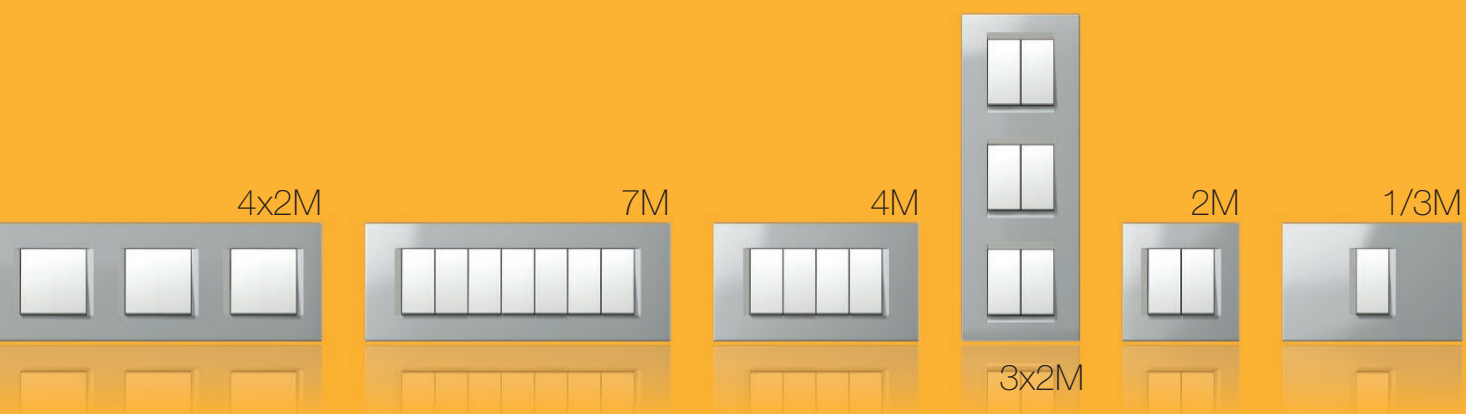

$$1M = \text{[rectangle]}$$

$$2M = \text{[rectangle]} \text{ [rectangle]} = \text{[square]}$$

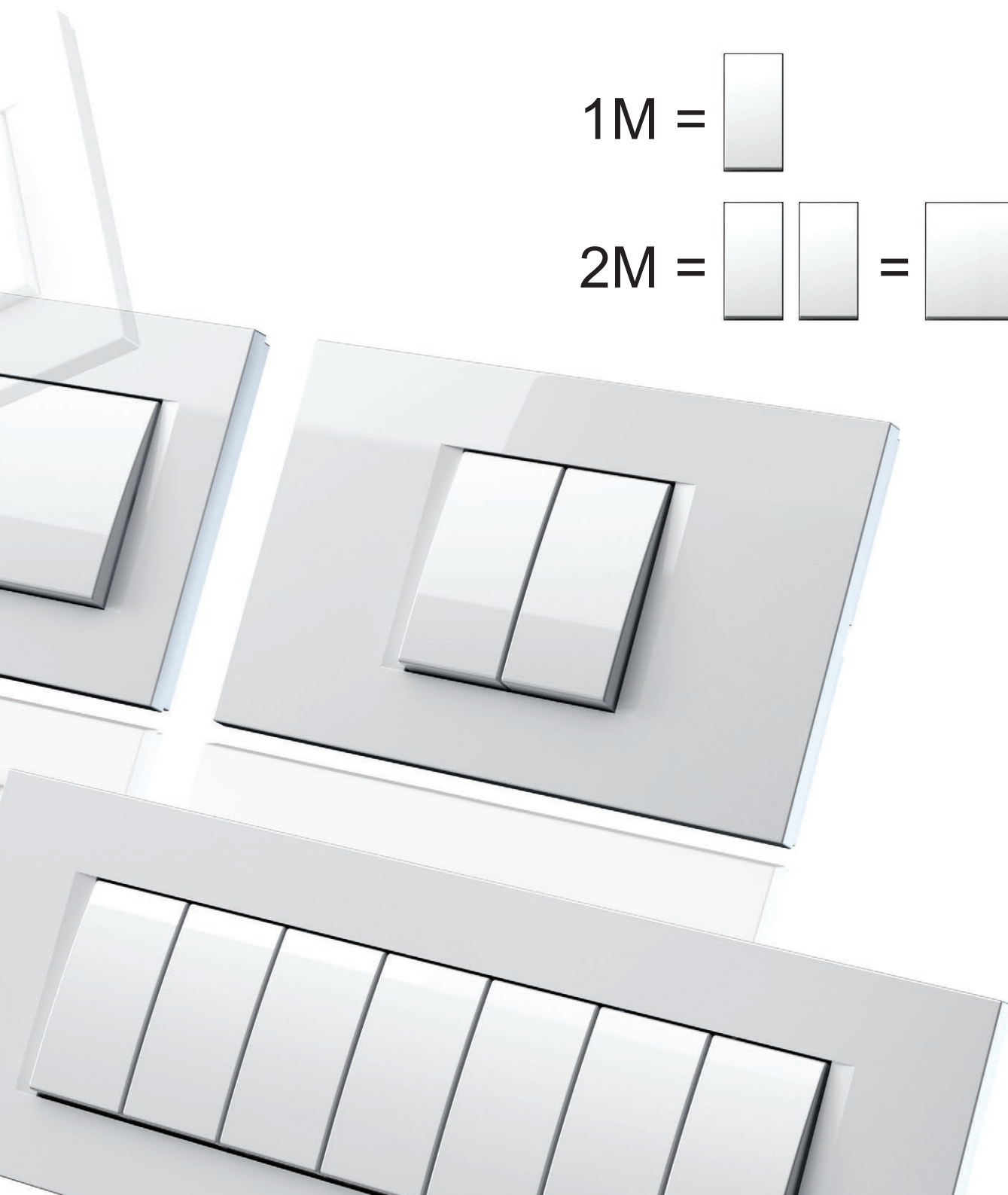



# univerzalnost

## universality

Sistem odlikujeta popoln izbor elementov in enostavna vgradnja.  
Set stikal lahko umestite v prostor na veliko načinov,  
naj bo doza okrogla ali pravokotna, samostojna ali v nizu.

The system features a comprehensive selection of elements and is  
easy to install. Switch sets can be positioned in many different ways,  
regardless of whether the box is round or rectangular, individual or  
serial.

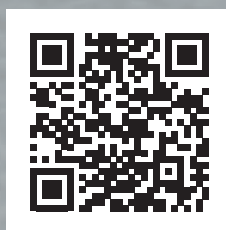

[modulmanager.tem.si](http://modulmanager.tem.si)

Preizkusite orodje "ModulManager",  
ki vam bo pomagal  
sestaviti poljubne kombinacije.

Try out the "ModulManager" tool,  
which will help you put together  
any combination you want.

## rešitve za primer 4 stikal

### solutions for 4 switches

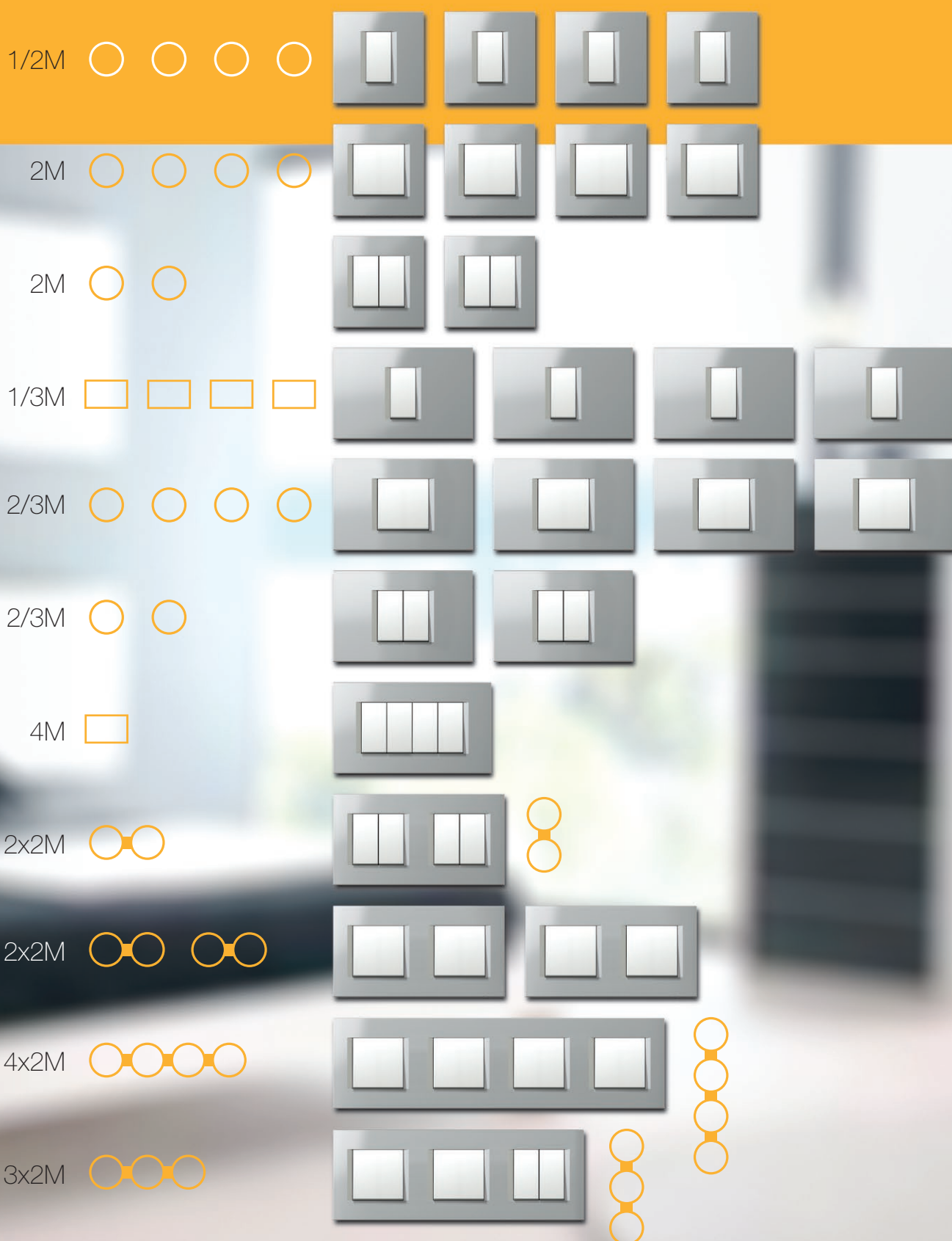

# MODUL MANAGER

enostavno in hitro / easy and fast







## konfigurator stikal in vtičnic configurator of switches and sockets

Modul Manager vam omogoča popolno in hitro izdelavo popisa stikal z gradbišča ali domačega naslonjača. Pripravili smo vam edinstven način naročanja, ki je praktičen in hiter, na voljo imate možnost kreiranja barv stikal in oblik okvirjev, da jih lahko prilagodite vašemu prostoru ali zahtevi kupca. Preizkusite nas, potrebujete le telefon, tablico ali računalnik in <http://modulmanager.tem.si>.

The Modul Manager allows you to perform a complete and quick inventory of switches from the building site itself or from the comfort of your own home. We have prepared a unique ordering method, which is both practical and quick. You can select the colours of the switches, as well as the shape of the frames, meaning you can tailor them to your space or the client's demands. Why not try us out? All you need is a smartphone, a tablet, or a computer and <http://modulmanager.tem.si>.

# funkcionalnost

## functionality

Modul smo razvili za vse, ki znate ceniti premišljeno načrtovan izdelek. Sistem potrebuje manj prostora, saj je v isti okvir možno sestaviti poljubno kombinacijo funkcijskih elementov. Primeren je za novogradnje in adaptacije.

The Modul was developed for those who can appreciate a thoughtfully designed product. The system takes up less space, as any combination of function elements can be fitted inside the same cover plate. It is suitable for new, as well as renovated buildings.



Modul Soft tudi v antibakterijski izvedbi AW.

The Modul Soft is also available in an antibacterial solution AW.

dekorativni okvirji  
decorative cover plates

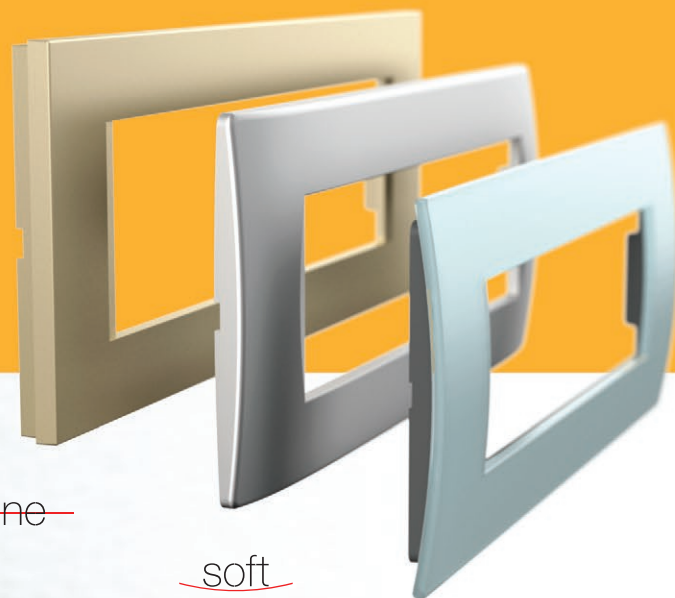

—line—

—soft—

PURE



funkcijski elementi  
function elements





# enostavnost simplicity

Funkcijske elemente enostavno pritrdite v nosilec. Za vas smo razvili rešitev "klik-in, klik-out", ki vam skrajša čas montaže. Priključni kontakti so lahko dostopni s sprednje strani.

The function elements are easily fitted inside the mounting frame. The "klik-in, klik-out" solution we have developed for you will reduce installation time. The connection contacts are easily accessible from the front.

line  
soft  
PURE

klik-in, klik-out

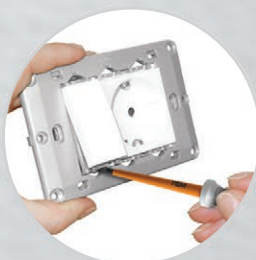
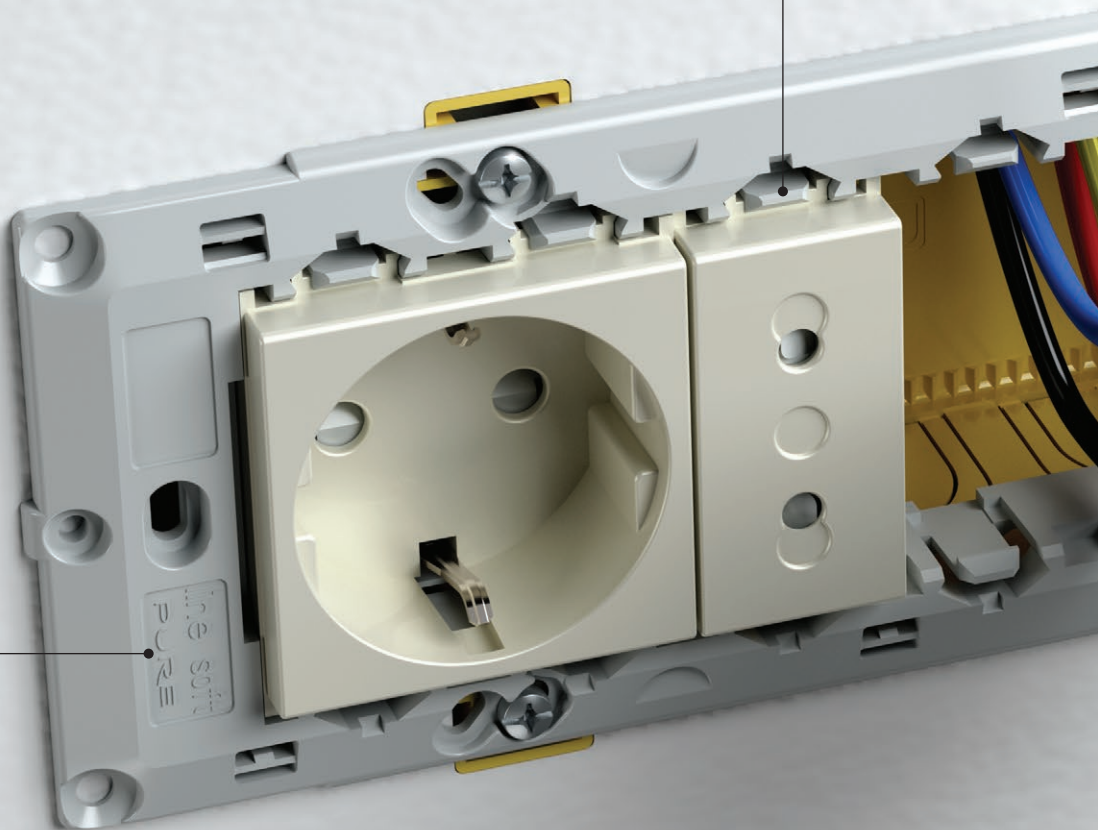

"klik-out" - enostavno in hitro, brez vijačenja.

"klik-out" - simple and quick, no screws necessary.

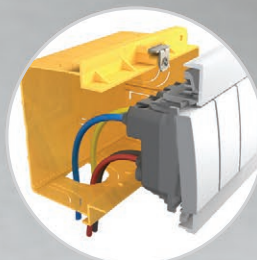

V pravokotnih dozah je več prostora za priključne vodnike.

Rectangular boxes have more space for connection wires.

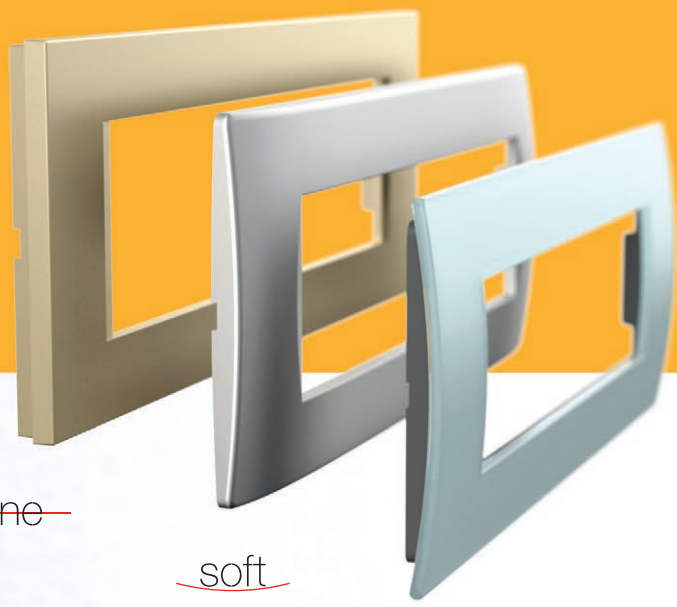
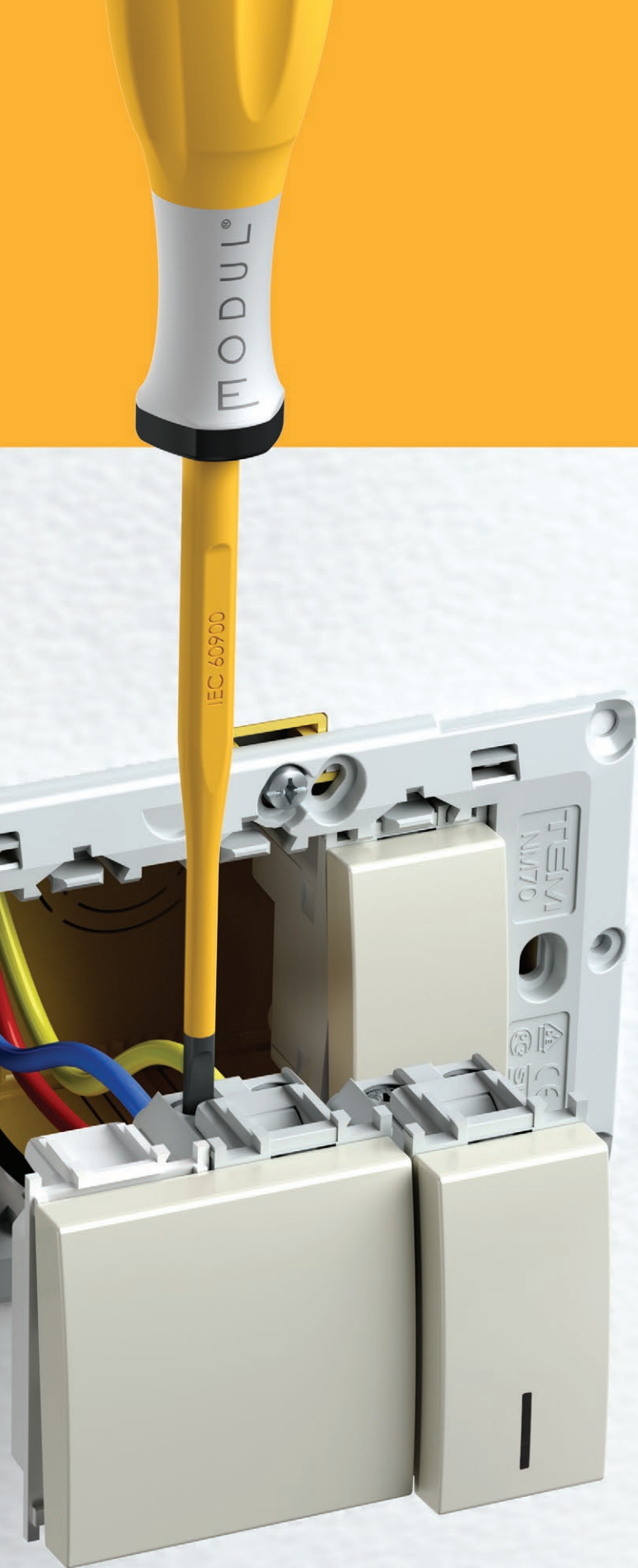

~~line~~

soft

PURE

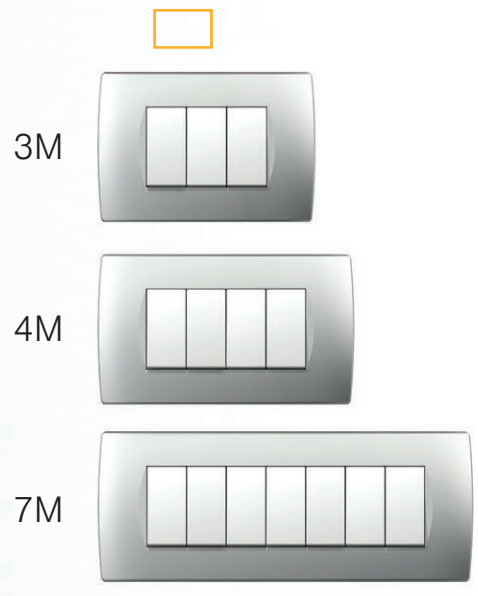



# sestavljivost

## combinability

Modul vam ponuja veliko možnosti tudi ob uporabi okroglih doz. Kombinirate lahko vodoravno ali navpično, samostojno ali v skupinah. Kovinski nosilec zagotavlja odlično stabilnost tudi pri grobi uporabi in je primeren za vse dekorativne okvirje.

The Modul enables a many possibilities even with round boxes. You can combine them horizontally or vertically, individually or in groups. The metal mounting frame ensures excellent stability even with rough use and is suitable for any decorative cover plates.

line  
soft  
PURE

klik-in, klik-out

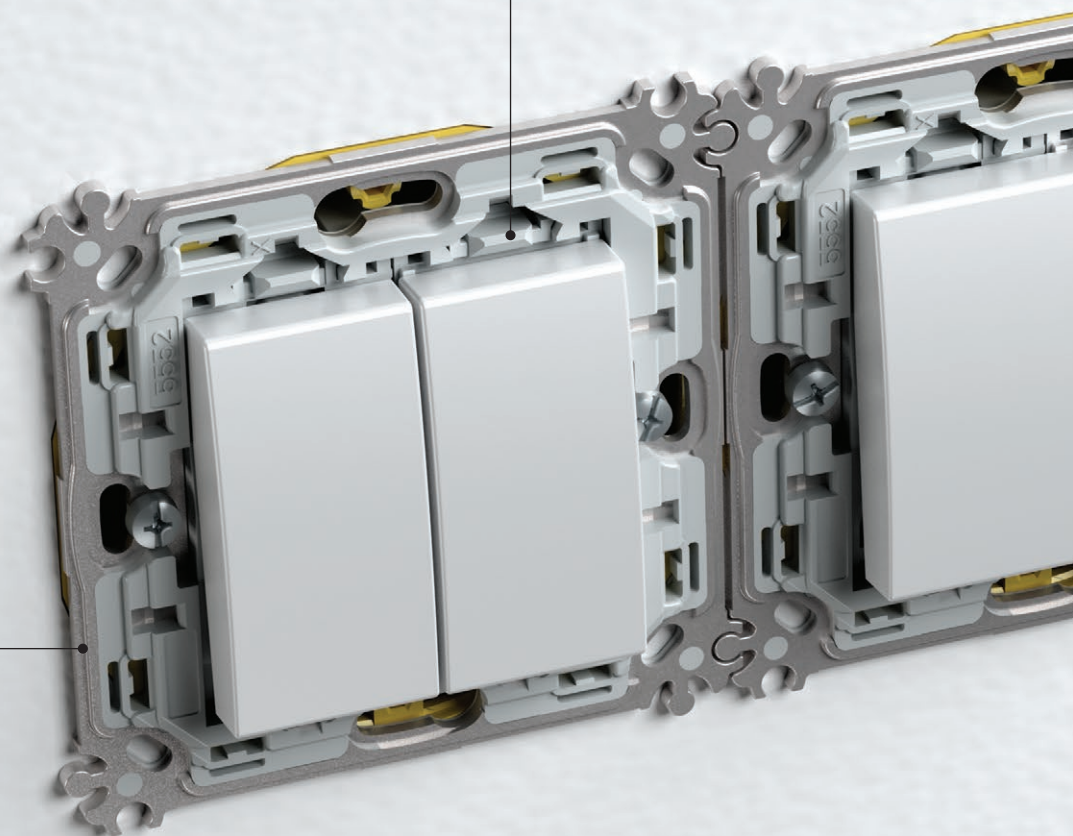

Isti okvir je možno uporabiti vodoravno ali navpično.  
The same cover plate can be positioned horizontally or vertically.

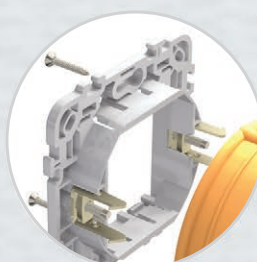

Nosilci se lahko pritrdijo z vijaki ali krepeljci.  
Mounting frames can be fixed with screws or claws.





—line—

—soft—

PURE



2M



2x2M



3x2M



4x2M



5x2M



Nosilce velikosti 2M je mogoče s preprostim preklopom povezati v večje skupine.

2M mounting frames are easily joined into groups.

# univerzalnost

universality

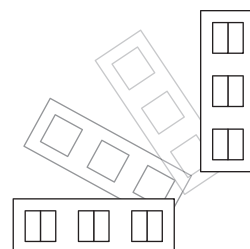
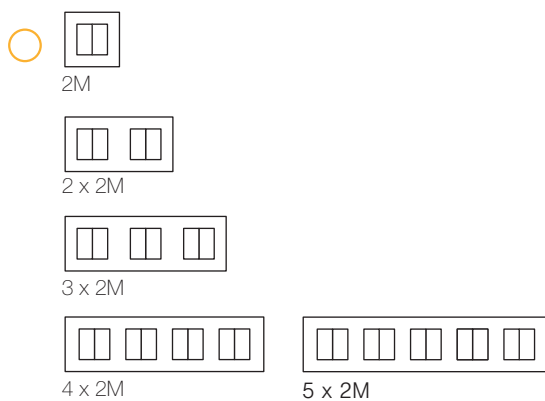
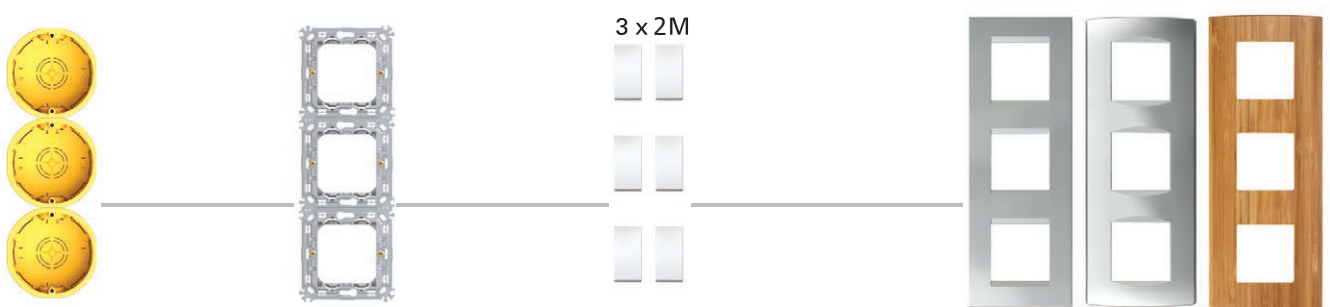
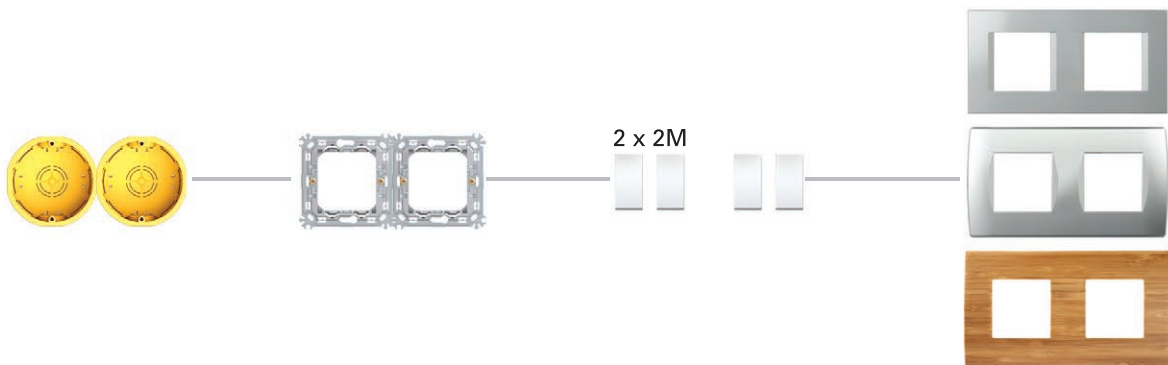
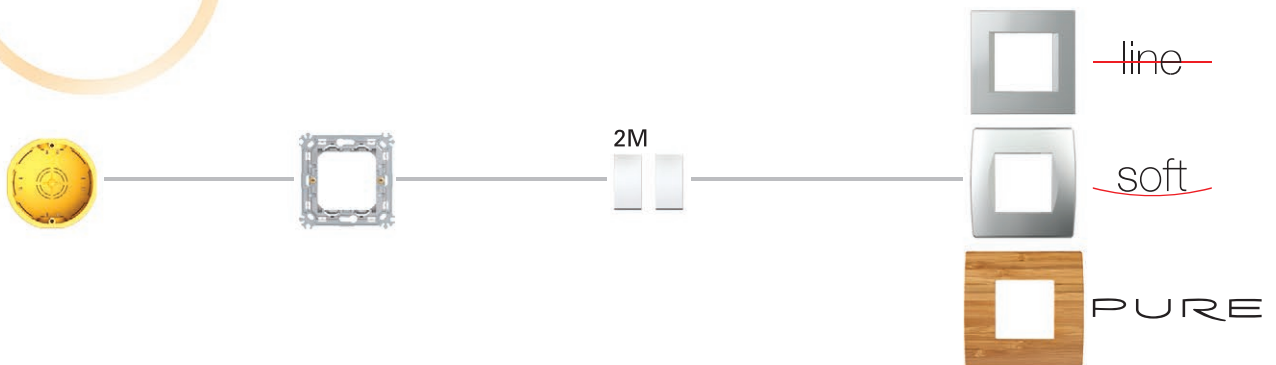

Sistem je univerzalen, primeren za vgradnjo v okrogle in pravokotne doze.

The system is universal and can be fitted in both round and rectangular boxes.

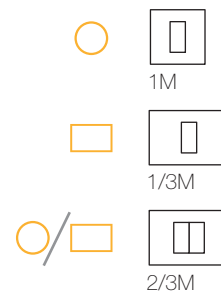
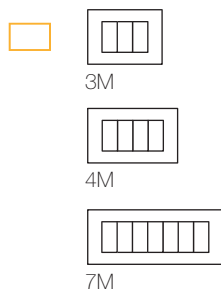
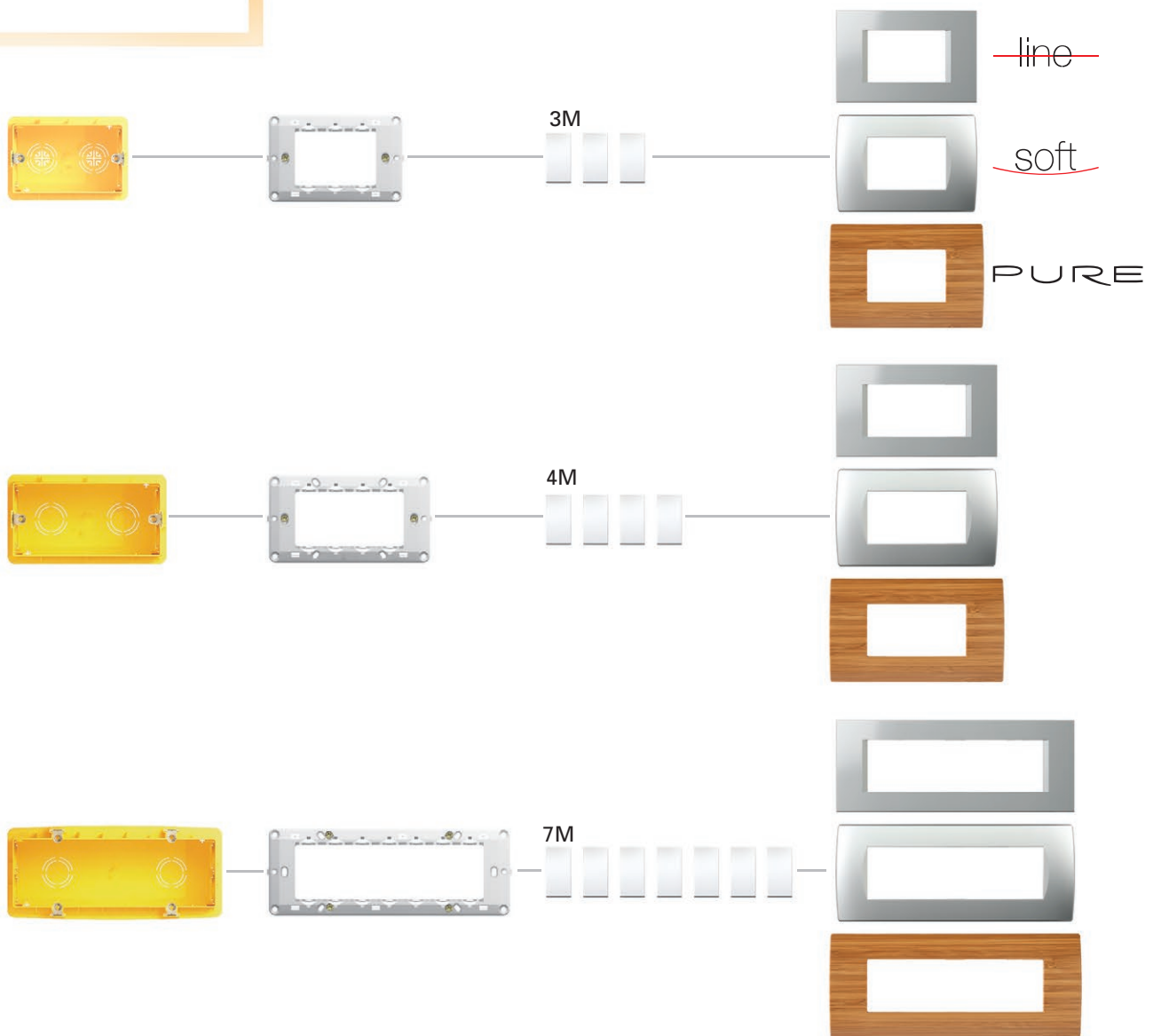
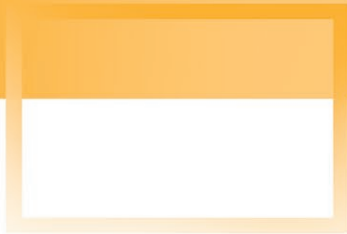



# funkcijski elementi

function elements

• stikala /  
switches



• vstop /  
entrance

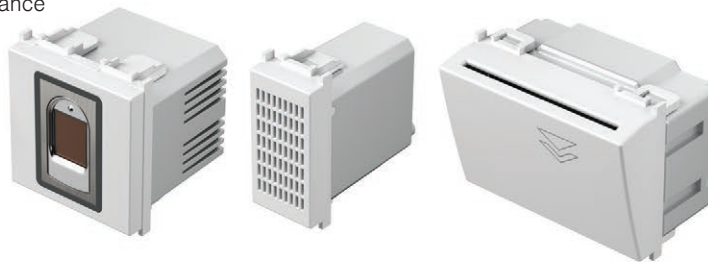

MODUL

• varčevanje z energijo /  
energy saving

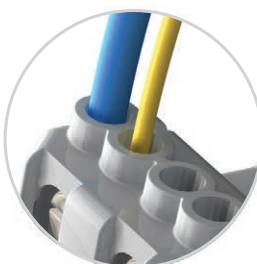

Zanesljiva priključitev vodnikov različnih premerov.  
Reliable connection even when different size of wires are used.



Dolga življenska doba stikal in ustreznost sodobnim standardom.  
Long-life of switches and adequacy to the international standards.

We have designed a wide selection of function element for the Modul family. You can use them to design both simple and complex installations.

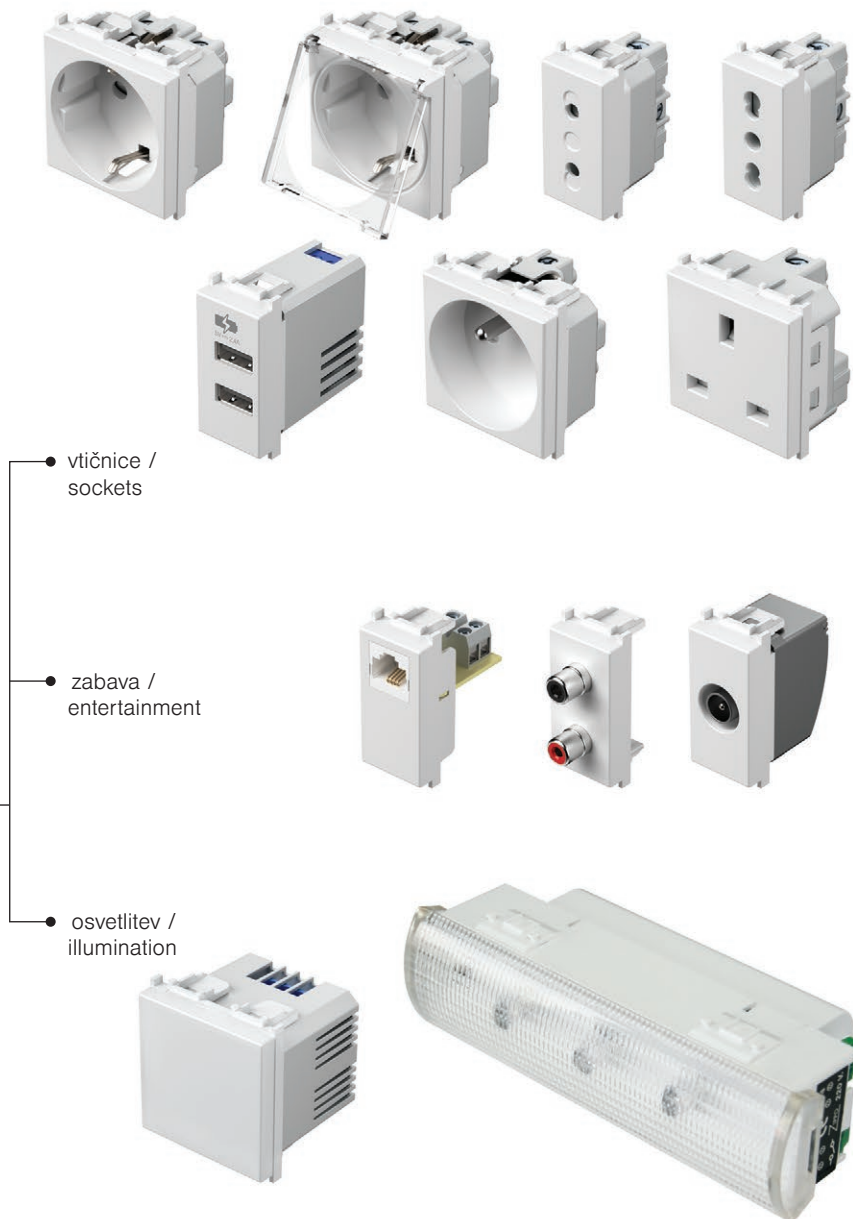

• vtičnice / sockets

• zabava / entertainment

• osvetlitev / illumination



Vse vtičnice imajo vgrajeno varovalo pred dotikom elementov pod napetostjo.

All the sockets are equipped with a safety shutters assuring the protection to live contacts.



**16 AX**  
kontakti

Zanesljivost preklopa omogočajo srebrne kontaktne kovice.

The switch is highly reliable via its silver rivets contacts.

# edinstvena širina uporabnosti

unique range of usability

Modul Soft AW  
antibakterijska izvedba /  
antibacterial solution



# MODUL

CUBO IP20

nadometna ohišja  
surface mounted boxes



CUBO IP55

nadometna ohišja  
surface mounted boxes



IP44

podomet  
flush mounted





Opremljate dom, pisarno ali delavnico?

Modul lahko uporabite tako v bivalnih kot delovnih prostorih, zasebnih in javnih zgradbah. Edinstven je v tem, da lahko stikala in vtičnice vgradite tam, kjer jih potrebujete.

Are you furnishing your home, office or workshop? The Modul is suitable for living as well as working spaces and both private and public buildings. It is unique in that the switches and sockets can be fitted wherever they are needed.

**D**

opeka  
brick



**H**

votla stena  
hollow wall



**B**

beton  
concrete

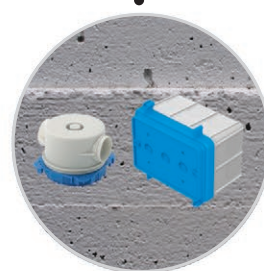

• funkcijski elementi /  
function elements

stikala / switches  
vtičnice / sockets  
komunikacije / communications  
senzorji / sensors  
regulatorji / regulators  
osvetlitve / illuminations

**MA**

parapetni kanali  
trunking systems



**MO**

razdelilne omarice  
distribution boards



**MT**

talne doze  
floor boxes



# podometne rešitve

## flush mounted solutions

opeka / brick

Modul lahko vgradite v katerokoli vrsto stene, naj bo klasična, suho montažna ali betonska. Vgradnja je enostavna, ponuja vam možnosti sestavljanja pravokotnih ali okroglih doz na ustrezne razdalje. Uporabljeni materiali so testirani po visokih standardih.

The Modul is suitable for all wall types and can be used in conventional, hollow wall or concrete constructions. It is easy to install and enables you to combine rectangular or round boxes at the proper distances. The materials used are compliant with high standards.



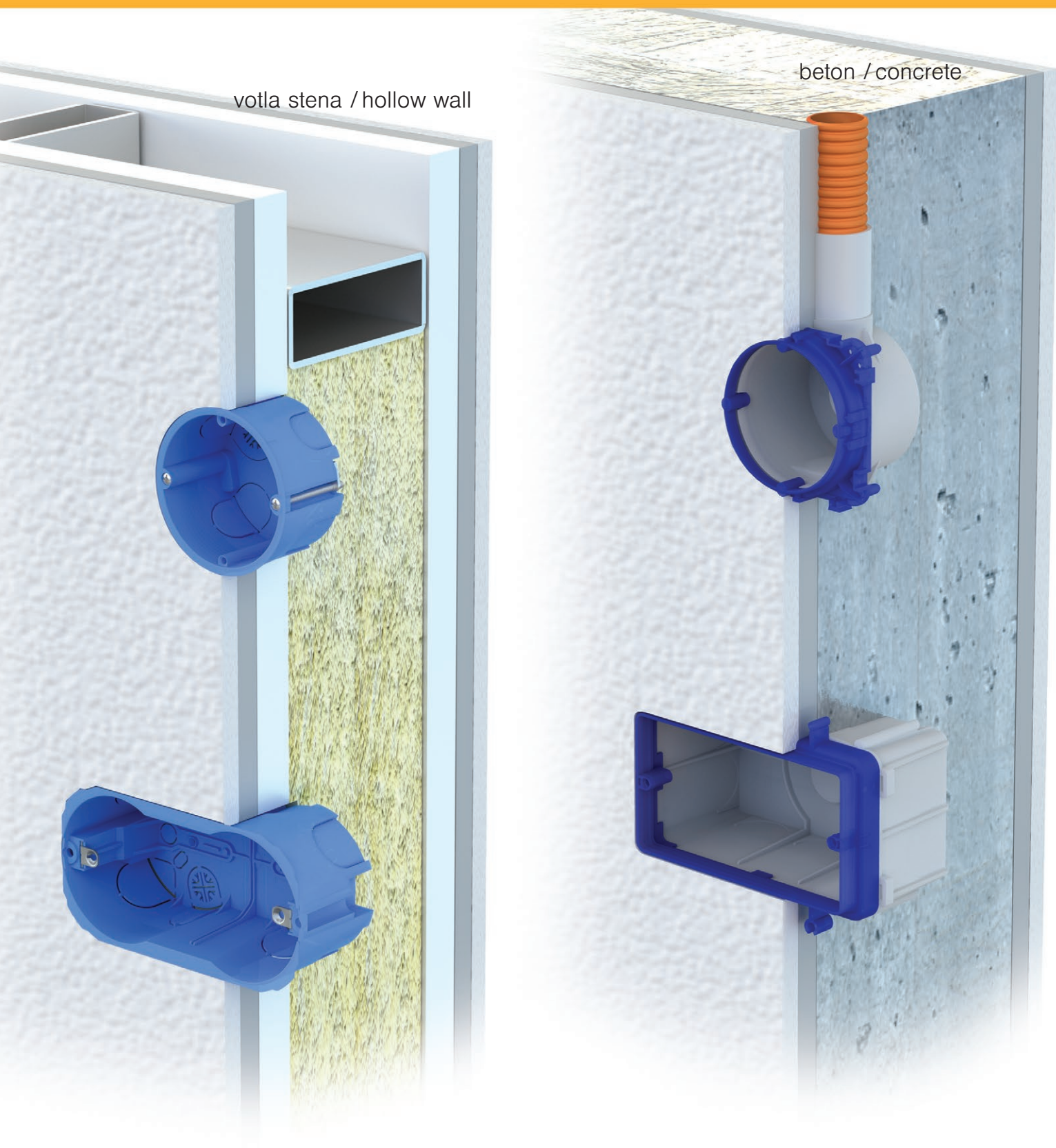



# druge rešitve

other solutions

IP44  
podomet  
flush mounted



CUBO IP20  
nadometna ohišja  
surface mounted boxes

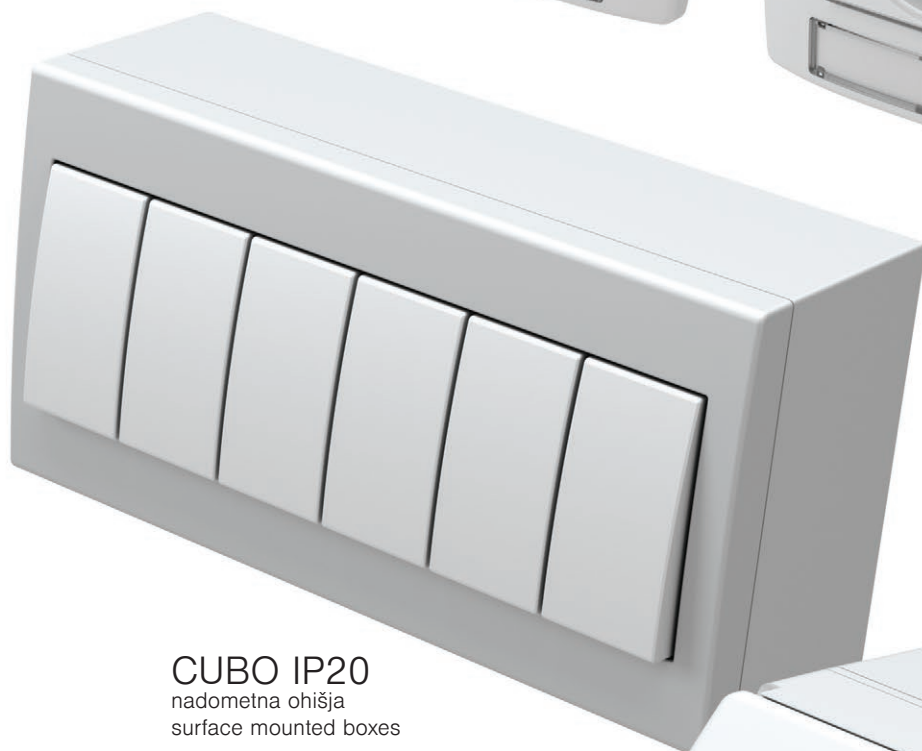

CUBO IP55  
nadometna ohišja  
surface mounted boxes



Potrebujete stikalo ali vtičnico v podometni, nadometni ali talni izvedbi?  
Modul ponuja različne rešitve vgradnje, v različnih IP zaščitah, v  
parapetne kanale, razdelilne omarice ali talne doze. Izbira je vaša.

Do you need switch or socket in flush, surface or floor solution?  
The Modul provides different mounting solutions with different IP  
protections, for trunking systems, distribution boards or floor boxes.  
The choice is yours.



**MA**

parapetni kanali  
trunking systems

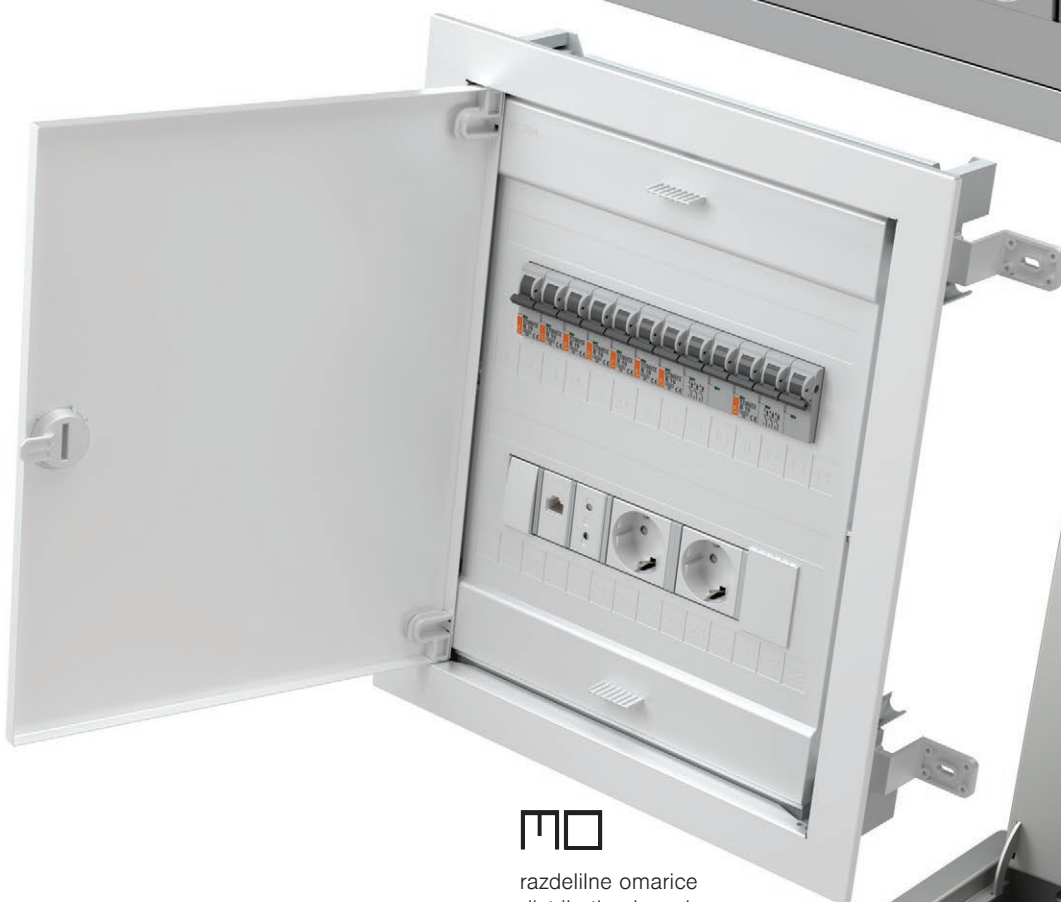

**MO**

razdelilne omarice  
distribution boards

**MT**

talne doze  
floor boxes



# tehnični katalog

technical catalogue







MODUL

— funkcijski elementi  
*function elements*



66

dizajn  
*design*

PURE  
~~line~~  
soft



116

doze  
*boxes*



136

distribucija  
*distribution*



158

ekonomik —



182

fontana —



210

TEM



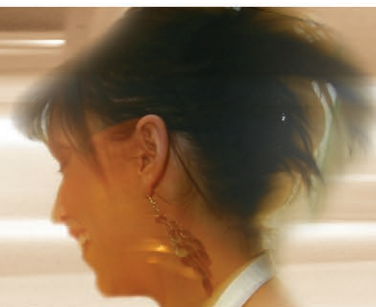

## FUNKCIJSKI ELEMENTI FUNCTION ELEMENTS

STIKALA SM  
SWITCHES SM



68

TIPKE TM  
BUTTONS TM



73

INDIKACIJA IA  
ILLUMINATION IA



76

VTIČNICE VM  
SOCKETS VM



78

KOMUNIKACIJE KM  
COMMUNICATIONS KM



82

KOMUNIKACIJSKI PRIBOR KA  
COMMUNICATION ACCESSORIES KA



88

ELEKTRONIKA EM  
ELECTRONICS EM



91

SETI CM  
SETS CM



110

ANTIBAKTERIJSKI PROGRAM AW  
ANTIBACTERIAL PROGRAM AW



115

## OBLIKA DESIGN

OKVIRJI PURE OP  
COVER PLATES PURE OP



120

OKVIRJI LINE OL  
COVER PLATES LINE OL



124

OKVIRJI SOFT OS  
COVER PLATES SOFT OS



128

NOSILCI NM  
MOUNTING FRAMES NM



134



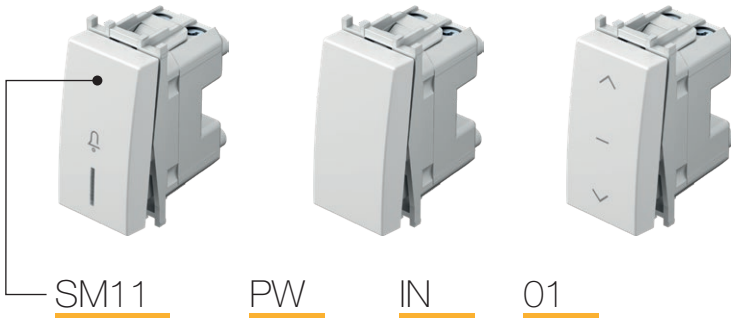

tip type	naziv description	tehnični opis technical data	velikost size	barva colour	opcijski opis 1 optional data 1	opcijski opis 2 optional data 2
SM10	STIKALO ENOPOLNO SWITCH 1WAY	16AX 250V~	1M	<input type="checkbox"/> PW bela-sijaj polar white	<input type="checkbox"/> NT nevtral neutral	01
SM11	TIPKALO ENOPOLNO PUSH BUTTON 1WAY	16A 250V~	1M	<input checked="" type="checkbox"/> SB črna-mat soft touch black	<input type="checkbox"/> IN indikator indicator	02
SM12	STIKALO ENOPOLNO SWITCH 1WAY	20A 250V~	1M	<input checked="" type="checkbox"/> AT antracit anthracite		03
⋮	⋮	⋮	⋮	<input type="checkbox"/> ES srebrna-mat elox silver		
⋮	⋮	⋮	⋮	<input type="checkbox"/> IW bež-sijaj ivory white		

STIKALO ENOPOLNO 16AX 250V~ 1M



SM10

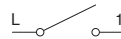

- stikalo brez tipke
  - 16AX 250V~, tip SM10
  - ustreza EN 60669-1
  - vijajna pritrditev vodnikov 1.5-2.5mm<sup>2</sup>
- SWITCH 1WAY 16AX 250V~ 1M**
- switch without button
  - 16AX 250V~, type SM10
  - in accordance with EN 60669-1
  - screw contacts 1.5-2.5mm<sup>2</sup>

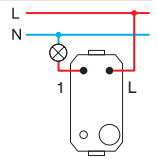

TIPKALO ENOPOLNO 16A 250V~ 1M



SM11



- tipkalo brez tipke
  - 16A 250V~, tip SM11
  - ustreza EN 60669-1
  - vijajna pritrditev vodnikov 1.5-2.5mm<sup>2</sup>
- PUSH BUTTON 1WAY 16A 250V~ 1M**
- push button without button
  - 16A 250V~, type SM11
  - in accordance with EN 60669-1
  - screw contacts 1.5-2.5mm<sup>2</sup>

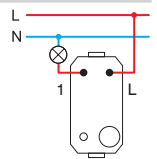

STIKALO ENOPOLNO 20A 250V~ 1M



SM12



- stikalo brez tipke
  - 20A 250V~, tip SM12
  - ustreza EN 60669-1
  - vijajna pritrditev vodnikov 1.5-2.5mm<sup>2</sup>
- SWITCH 1WAY 20A 250V~ 1M**
- switch without button
  - 20A 250V~, type SM12
  - in accordance with EN 60669-1
  - screw contacts 1.5-2.5mm<sup>2</sup>

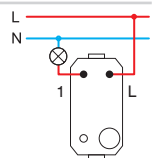

STIKALO DVOPOLNO 16AX 250V~ 1M



SM20

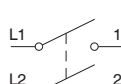

- stikalo brez tipke
  - 16AX 250V~, tip SM20
  - ustreza EN 60669-1
  - vijajna pritrditev vodnikov 1.5-2.5mm<sup>2</sup>
  - samo v kombinaciji s tipko TM15
- SWITCH 2POLE 16AX 250V~ 1M**
- switch without button
  - 16AX 250V~, type SM20
  - in accordance with EN 60669-1
  - screw contacts 1.5-2.5mm<sup>2</sup>
  - only in combination with button TM15

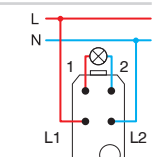



SM40

## STIKALO ŽALUZIJSKO 1-0-2 16AX 250V~ 1M

- stikalo brez tipke
- 16AX 250V~, tip SM40
- ustreza EN 60669-1
- vijačna pritrditev vodnikov 1.5-2.5mm<sup>2</sup>

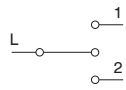

## SWITCH SHUTTERS 1-0-2 16AX 250V~ 1M

- switch without button
- 16AX 250V~, type SM40
- in accordance with EN 60669-1
- screw contacts 1.5-2.5mm<sup>2</sup>

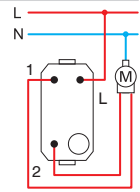

SM41

## TIPKALO ŽALUZIJSKO 1-0-2 16A 250V~ 1M

- tipkalo brez tipke
- 16A 250V~, tip SM41
- ustreza EN 60669-1
- vijačna pritrditev vodnikov 1.5-2.5mm<sup>2</sup>

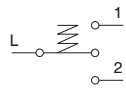

## PUSH BUTTON SHUTTERS 1-0-2 16A 250V~ 1M

- push button without button
- 16A 250V~, type SM41
- in accordance with EN 60669-1
- screw contacts 1.5-2.5mm<sup>2</sup>

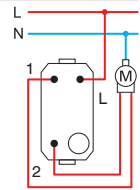

SM60

## STIKALO MENJALNO 16AX 250V~ 1M

- stikalo brez tipke
- 16AX 250V~, tip SM60
- ustreza EN 60669-1
- vijačna pritrditev vodnikov 1.5-2.5mm<sup>2</sup>

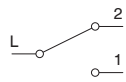

## SWITCH 2WAY 16AX 250V~ 1M

- switch without button
- 16AX 250V~, type SM60
- in accordance with EN 60669-1
- screw contacts 1.5-2.5mm<sup>2</sup>

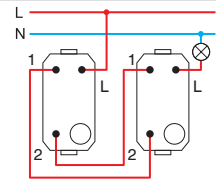

SM61

## TIPKALO MENJALNO 16A 250V~ 1M

- tipkalo brez tipke
- 16A 250V~, tip SM61
- ustreza EN 60669-1
- vijačna pritrditev vodnikov 1.5-2.5mm<sup>2</sup>

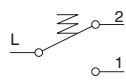

## PUSH BUTTON 2WAY 16A 250V~ 1M

- push button without button
- 16A 250V~, type SM61
- in accordance with EN 60669-1
- screw contacts 1.5-2.5mm<sup>2</sup>

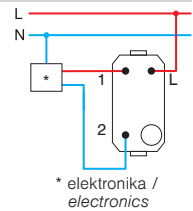

SM70

## STIKALO KRIŽNO 16AX 250V~ 1M

- stikalo brez tipke
- 16AX 250V~, tip SM70
- ustreza EN 60669-1
- vijačna pritrditev vodnikov 1.5-2.5mm<sup>2</sup>

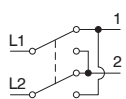

## SWITCH INTERMEDIATE 16AX 250V~ 1M

- switch without button
- 16AX 250V~, type SM70
- in accordance with EN 60669-1
- screw contacts 1.5-2.5mm<sup>2</sup>

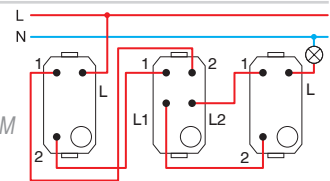

1M = 22,5 x 45  
2M = 45 x 45

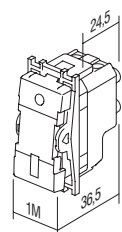
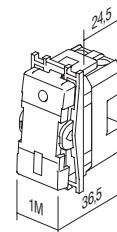



□ PW bela-sijaj  
polar white



■ SB črna-mat  
soft touch black



■ AT antracit  
anthracite



□ ES srebrna-mat  
elox silver



□ IW bež-sijaj  
ivory white

STIKALO ENOPOLNO 16AX 250V~ 1M



- SM10PW
- SM10SB
- SM10AT
- SM10ES
- SM10IW

- 16AX 250V~, tip SM10  
- ustreza EN 60669-1  
- vijajčna pritrditev vodnikov 1.5-2.5 mm<sup>2</sup>  
- zamenljiva tipka

SWITCH 1WAY 16AX 250V~ 1M

- 16AX 250V~, type SM10  
- in accordance with EN 60669-1  
- screw contacts 1.5-2.5 mm<sup>2</sup>  
- replaceable button



STIKALO ENOPOLNO 16AX 250V~ 1M \_\_ IN



- SM10PWIN
- SM10SBIN
- SM10ATIN
- SM10ESIN
- SM10IWIN

- IN indikator  
- 16AX 250V~, tip SM10  
- ustreza EN 60669-1  
- vijajčna pritrditev vodnikov 1.5-2.5 mm<sup>2</sup>  
- tipka ni priložena  
- zamenljiva tipka

SWITCH 1WAY 16AX 250V~ 1M \_\_ IN

- IN indicator  
- 16AX 250V~, type SM10  
- in accordance with EN 60669-1  
- screw contacts 1.5-2.5 mm<sup>2</sup>  
- lamp is not included  
- replaceable button



TIPKALO ENOPOLNO 16A 250V~ 1M



- SM11PW
- SM11SB
- SM11AT
- SM11ES
- SM11IW

- 16A 250V~, tip SM11  
- ustreza EN 60669-1  
- vijajčna pritrditev vodnikov 1.5-2.5 mm<sup>2</sup>  
- zamenljiva tipka

PUSH BUTTON 1WAY 16A 250V~ 1M

- 16A 250V~, type SM11  
- in accordance with EN 60669-1  
- screw contacts 1.5-2.5 mm<sup>2</sup>  
- replaceable button



TIPKALO ENOPOLNO 16A 250V~ 1M \_\_ IN 01



- SM11PWIN01
- SM11SBIN01
- SM11ATIN01
- SM11ESIN01
- SM11IWIN01

- IN 01 indikator zvonec  
- 16A 250V~, tip SM11  
- ustreza EN 60669-1  
- vijajčna pritrditev vodnikov 1.5-2.5 mm<sup>2</sup>  
- tipka ni priložena  
- zamenljiva tipka

PUSH BUTTON 1WAY 16A 250V~ 1M \_\_ IN 01

- IN 01 indicator bell  
- 16A 250V~, type SM11  
- in accordance with EN 60669-1  
- screw contacts 1.5-2.5 mm<sup>2</sup>  
- lamp is not included  
- replaceable button





## S W I T C H E S S M

## TIPKALO ENOPOLNO 16A 250V~ 1M \_\_ IN 02



- SM11PWIN02 - IN 02 indikator luč
- SM11SBIN02 - 16A 250V~, tip SM11
- SM11ATIN02 - ustreza EN 60669-1
- SM11ESIN02 - vijačna pritrditev vodnikov 1.5-2.5 mm<sup>2</sup>
- SM11WIN02 - tlvka ni priložena
- zamenljiva tipka

*PUSH BUTTON 1WAY 16A 250V~ 1M \_\_ IN 02*

- IN 02 indicator light
- 16A 250V~, type SM11
- in accordance with EN 60669-1
- screw contacts 1.5-2.5 mm<sup>2</sup>
- lamp is not included
- replaceable button



## STIKALO DVOPOLNO 16AX 250V~ 1M \_\_ NT 03



- SM20PWNT03 - NT 03 nevtral 0-1
- SM20SBNT03 - 16AX 250V~, tip SM20
- SM20ATNT03 - ustreza EN 60669-1
- SM20ESNT03 - vijačna pritrditev vodnikov 1.5-2.5 mm<sup>2</sup>
- SM20IWNT03 - zamenljiva tipka

*SWITCH 2POLE 16AX 250V~ 1M \_\_ NT 03*

- NT 03 neutral 0-1
- 16AX 250V~, type SM20
- in accordance with EN 60669-1
- screw contacts 1.5-2.5 mm<sup>2</sup>
- replaceable button



## STIKALO DVOPOLNO 16AX 250V~ 1M \_\_ IN



- SM20PWIN - IN indikator
- SM20SBIN - 16AX 250V~, tip SM20
- SM20ATIN - ustreza EN 60669-1
- SM20ESIN - vijačna pritrditev vodnikov 1.5-2.5 mm<sup>2</sup>
- SM20IWIN - tlvka ni priložena
- zamenljiva tipka

*SWITCH 2POLE 16AX 250V~ 1M \_\_ IN*

- IN indicator
- 16AX 250V~, type SM20
- in accordance with EN 60669-1
- screw contacts 1.5-2.5 mm<sup>2</sup>
- lamp is not included
- replaceable button



## STIKALO ŽALUZIJSKO 1-0-2 16AX 250V~ 1M \_\_ NT 10

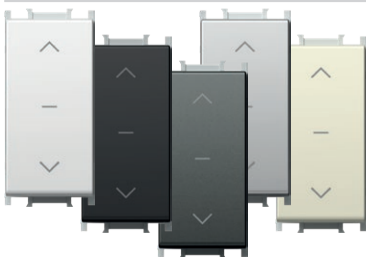

- SM40PWNT10 - NT 10 nevtral 1-0-2
- SM40SBNT10 - 16AX 250V~, tip SM40
- SM40ATNT10 - ustreza EN 60669-1
- SM40ESNT10 - vijačna pritrditev vodnikov 1.5-2.5mm<sup>2</sup>
- SM40IWNT10 - zamenljiva tipka

*SWITCH SHUTTERS 1-0-2 16AX 250V~ 1M \_\_ NT 10*

- NT 10 neutral 1-0-2
- 16AX 250V~, type SM40
- in accordance with EN 60669-1
- screw contacts 1.5-2.5mm<sup>2</sup>
- replaceable button



## TIPKALO ŽALUZIJSKO 1-0-2 16A 250V~ 1M \_\_ NT 10

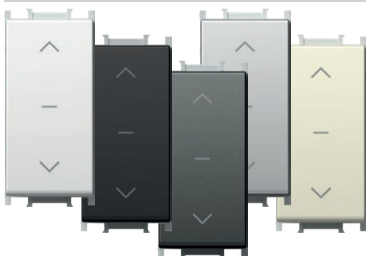

- SM41PWNT10 - NT 10 nevtral 1-0-2
- SM41SBNT10 - 16A 250V~, tip SM41
- SM41ATNT10 - ustreza EN 60669-1
- SM41ESNT10 - vijačna pritrditev vodnikov 1.5-2.5mm<sup>2</sup>
- SM41IWNT10 - zamenljiva tipka

*PUSH BUTTON SHUTTERS 1-0-2 16A 250V~ 1M \_\_ NT 10*

- NT 10 neutral 1-0-2
- 16A 250V~, type SM41
- in accordance with EN 60669-1
- screw contacts 1.5-2.5mm<sup>2</sup>
- replaceable button



## STIKALO MENJALNO 16AX 250V~ 1M



- SM60PW - 16AX 250V~, tip SM60
- SM60SB - ustreza EN 60669-1
- SM60AT - vijačna pritrditev vodnikov 1.5-2.5 mm<sup>2</sup>
- SM60ES - zamenljiva tipka

*SWITCH 2WAY 16AX 250V~ 1M*

- 16AX 250V~, type SM60
- in accordance with EN 60669-1
- screw contacts 1.5-2.5 mm<sup>2</sup>
- replaceable button



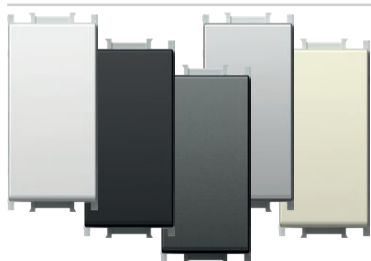

- SM61PW
- SM61SB
- SM61AT
- SM61ES
- SM61IW

TIPKALO MENJALNO 16A 250V~ 1M

- 16A 250V~, tip SM61
- ustreza EN 60669-1
- vijalna pritrditev vodnikov 1.5-2.5 mm<sup>2</sup>
- zamenljiva tipka

*PUSH BUTTON 2WAY 16A 250V~ 1M*

- 16A 250V~, type SM61
- in accordance with EN 60669-1
- screw contacts 1.5-2.5 mm<sup>2</sup>
- replaceable button



- SM62PWCD
- SM62SBCD
- SM62ATCD
- SM62ESCD
- SM62IWCD

TIPKALO MENJALNO Z VRVICO 16A 250V~ 1M \_\_ CD

- CD indikator+vrvica
- vrvica dolžine 1.5m
- 16A 250V~, tip SM62
- ustreza EN 60669-1
- vijalna pritrditev vodnikov 1.5-2.5 mm<sup>2</sup>

*PUSH BUTTON 2WAY WITH CORD 16A 250V~ 1M \_\_ CD*

- CD indikator+cord
- cord lenght 1.5m
- 16A 250V~, type SM62
- in accordance with EN 60669-1
- screw contacts 1.5-2.5 mm<sup>2</sup>



- SM70PW
- SM70SB
- SM70AT
- SM70ES
- SM70IW

STIKALO KRIŽNO 16AX 250V~ 1M

- 16AX 250V~, tip SM70
- ustreza EN 60669-1
- vijalna pritrditev vodnikov 1.5-2.5 mm<sup>2</sup>
- zamenljiva tipka

*SWITCH INTERMEDIATE 16AX 250V~ 1M*

- 16AX 250V~, type SM70
- in accordance with EN 60669-1
- screw contacts 1.5-2.5 mm<sup>2</sup>
- replaceable button



1M = 22,5 x 45  
2M = 45 x 45

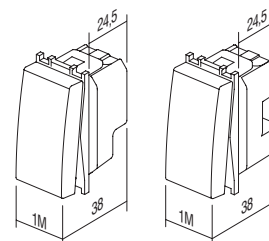

## B U T T O N S T M

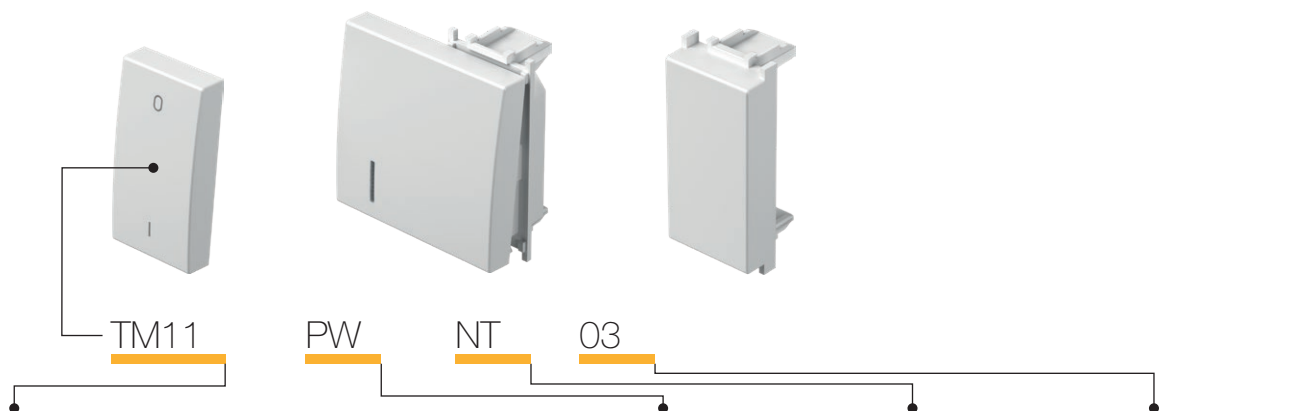

tip type	naziv description	velikost size	barva colour	opcijski opis 1 optional data 1	opcijski opis 2 optional data 2
TM11	TIPKA BUTTON	1M	<input type="checkbox"/> PW bela-sijaj polar white	<input type="checkbox"/> NT nevtral neutral	01
TM12	TIPKA BUTTON	2M	<input checked="" type="checkbox"/> SB črna-mat soft touch black	<input type="checkbox"/> IN indikator indicator	02
TM21	POLNILO BLANK	1M	<input checked="" type="checkbox"/> AT antracit anthracite		03
:	:	:	<input type="checkbox"/> ES srebrna-mat elox silver		
:	:	:	<input type="checkbox"/> IW bež-sijaj ivory white		

## TIPKA 1M



- TM11PW
- TM11SB
- TM11AT
- TM11ES
- TM11IW

- zamenljiva tipka velikosti 1M  
- ustreza EN 60669-1  
**BUTTON 1M**  
- replaceable button 1M  
- in accordance with EN 60669-1



## TIPKA 1M INDIKATOR



- TM11PWIN
- TM11ATIN
- TM11SBIN
- TM11ESIN
- TM11IWIN

- zamenljiva tipka velikosti 1M  
- ustreza EN 60669-1  
**BUTTON 1M INDICATOR**  
- replaceable button 1M  
- in accordance with EN 60669-1



## TIPKA 2M

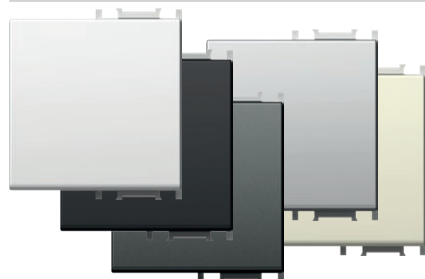

- TM12PW
- TM12SB
- TM12AT
- TM12ES
- TM12IW

- zamenljiva tipka velikost 2M z nosilcem tipke  
- uporablja se pri nadgradnji stikala ali tipkala velikosti 1M v velikost 2M  
- ustreza EN 60669-1  
**BUTTON 2M**  
- replaceable button 2M with button carrier  
- to upgrade switch or push button from size 1M to size 2M  
- in accordance with EN 60669-1



## TIPKA 2M INDIKATOR

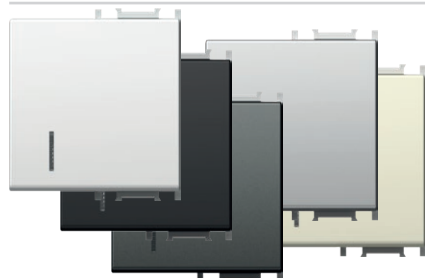

- TM12PWIN
- TM12SBIN
- TM12ATIN
- TM12ESIN
- TM12IWIN

- zamenljiva tipka velikost 2M z nosilcem tipke  
- uporablja se pri nadgradnji stikala ali tipkala velikosti 1M v velikost 2M  
- ustreza EN 60669-1  
**BUTTON 2M INDICATOR**  
- replaceable button 2M with button carrier  
- to upgrade switch or push button from size 1M to size 2M  
- in accordance with EN 60669-1





TIPKA 2M Z NAPISNO PLOŠČICO

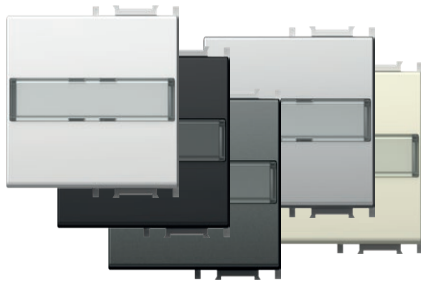

- TM13PWIL
- TM13SBIL
- TM13ATIL
- TM13ESIL
- TM13IWIL

- zamenljiva tipka velikost 2M z nosilcem tipke  
 - uporablja se pri nadgradnji stikala ali tipkala velikosti 1M v velikost 2M  
 - ustreza EN 60669-1

*BUTTON 2M WITH INSCRIPTION PLATE*

- replaceable button 2M with button carrier  
 - to upgrade switch or push button from size 1M to size 2M  
 - in accordance with EN 60669-1



TIPKA 1M DVOPOLNA

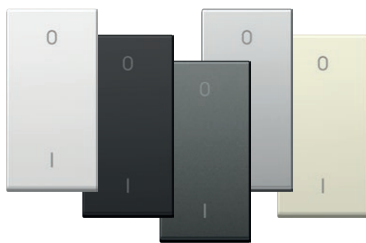

- TM15PW
- TM15SB
- TM15AT
- TM15ES
- TM15IW

- zamenljiva tipka velikosti 1M  
 - samo v kombinaciji z mehanizmom SM20  
 - ustreza EN 60669-1

*BUTTON 1M 2POLE*

- replaceable button 1M  
 - only in combination with mechanism SM20  
 - in accordance with EN 60669-1



POLNILO 1M

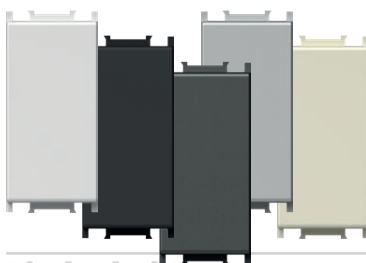

- TM21PW
- TM21SB
- TM21AT
- TM21ES
- TM21IW

- za zapolnjevanje praznih mest  
 - ustreza EN 60669-1

*BLANK 1M*

- blank modul to fill up empty spaces  
 - in accordance with EN 60669-1



POLNILO 2M



- TM22PW
- TM22SB
- TM22AT
- TM22ES
- TM22IW

- za zapolnjevanje praznih mest  
 - ustreza EN 60669-1

*BLANK 2M*

- blank modul to fill up empty spaces  
 - in accordance with EN 60669-1



UVODNICA 1M

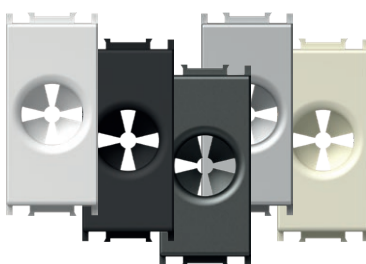

- TM31PW
- TM31SB
- TM31AT
- TM31ES
- TM31IW

- uvodnica za kabel  
 - ustreza EN-60669-1

*CABLE OUTLET 1M*

- outlet for cable  
 - in accordance with EN-60669-1



1M = 22,5 x 45  
 2M = 45 x 45

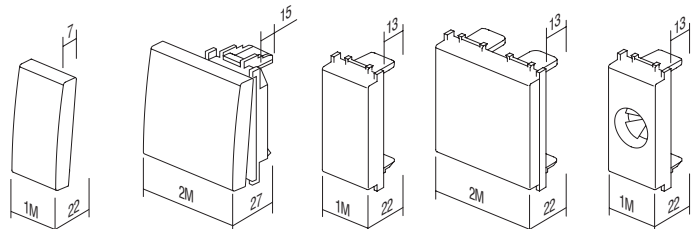

TM11  
 TM15

TM12  
 TM13

TM21

TM22

TM31

BUTTONS T M

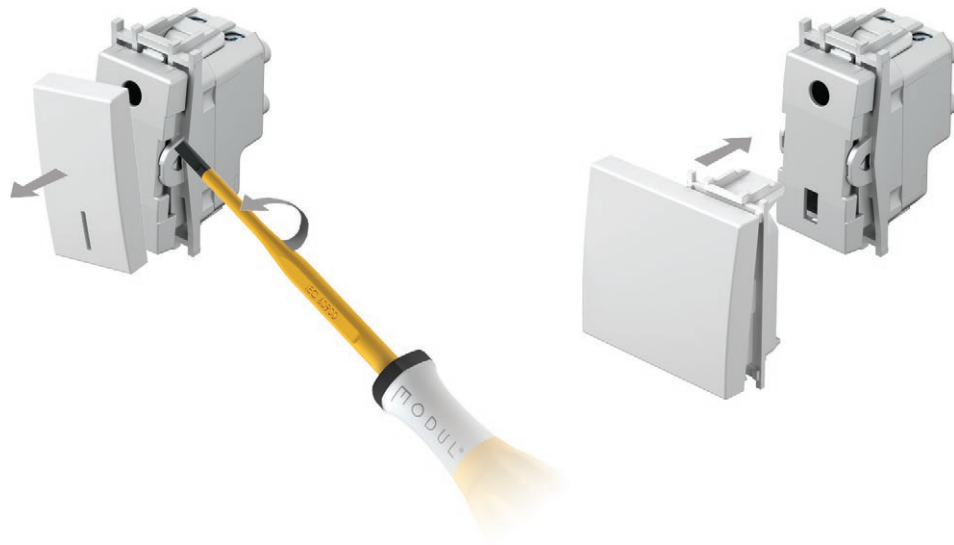

LASERSKI TISK NA TIPKE

- laserski tisk poljubne grafike na označena mesta
- standardni simboli iz zaloge, ostali po naročilu

LASER PRINT ON BUTTONS

- laser print of any graphics on marked locations
- standard symbols from stock, other on request

1M

A
B
C

2M

A	D	G
B	E	H
C	F	I

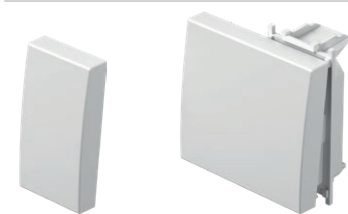

GRAFIKE

SYMBOLS

01	02	03	04	05	06	07	08	09	10	11	12	20	21	22	23
24	25	26	27	28	29	30	31	32	33	34	35	36	37	38	39
					OFF	ON					AC				
40	41	42	43	44	45	46	47	48							

STANDARDNE GRAFIKE

STANDARD SYMBOLS

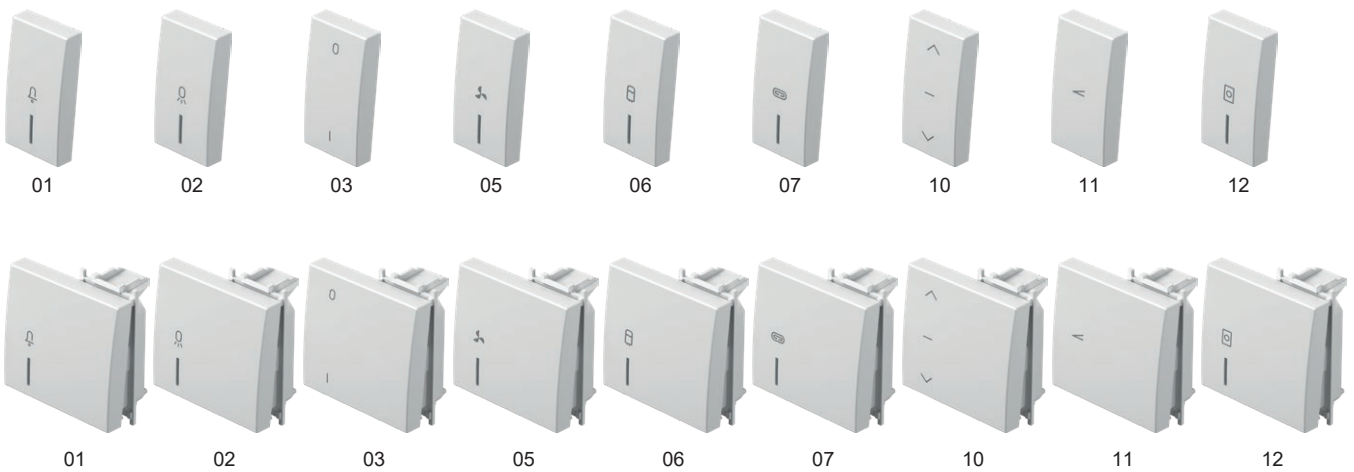

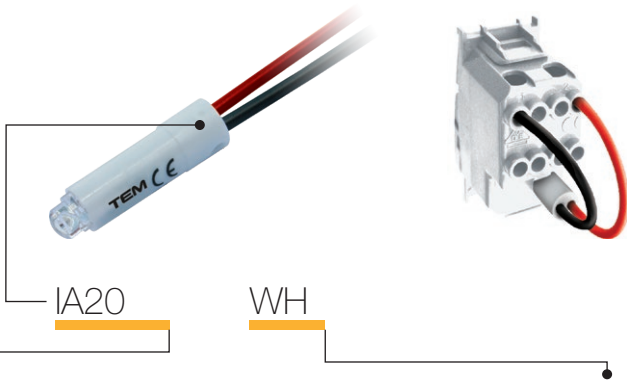

tip type	naziv description	tehnični opis technical data	barva colour
IA10	TLIVKA NEON LAMP	230V~ 0,34W	<input type="checkbox"/> WH bela white
IA20	SIJALKA LED LED LAMP	230V~ AC/DC 0,40W	<input checked="" type="checkbox"/> BL modra blue
IA21	SIJALKA LED LED LAMP	24V AC/DC 0,20W	<input checked="" type="checkbox"/> RD rdeča red
·	·	·	<input checked="" type="checkbox"/> GR zelena green
·	·	·	<input checked="" type="checkbox"/> OR oranžna orange

TLIVKA 230V~ 0,34W

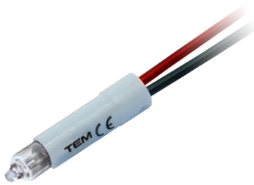

IA10OR

- za indikacijo, osvetlitev ali stalno osvetlitev stikala
  - v kombinaciji s tipko z indikatorjem
- NEON LAMP 230V~ 0,34W
- for indication, illumination or constant illumination of switch
  - in combination with button with indicator

SIJALKA LED 230V AC/DC 0,40W



IA20WH  
 IA20GR  
 IA20RD  
 IA20BL

- za indikacijo, osvetlitev ali stalno osvetlitev stikala
  - v kombinaciji s tipko z indikatorjem
- LED LAMP 230V AC/DC 0,40W
- for indication, illumination or constant illumination of switch
  - in combination with button with indicator

SIJALKA LED 24V AC/DC 0,20W



IA21WH  
 IA21RD

- za indikacijo, osvetlitev ali stalno osvetlitev stikala
  - v kombinaciji s tipko z indikatorjem
- LED LAMP 24V AC/DC 0,20W
- for indication, illumination or constant illumination of switch
  - in combination with button with indicator

SIJALKA LED 12V AC/DC 0,10W



IA22WH  
 IA22RD

- za indikacijo, osvetlitev ali stalno osvetlitev stikala
  - v kombinaciji s tipko z indikatorjem
- LED LAMP 12V AC/DC 0,10W
- for indication, illumination or constant illumination of switch
  - in combination with button with indicator

RC VEZJE 250V~



IA50

- RC vezje za odpravo motenj pri delovanju LED sijalk
- možna je vzporedna vezava več RC vezij s sijalkami
- 0,1 µF, 100 Ω, 250V~

RC CIRCUIT 250V~

- RC circuit to eliminate disturbances in the operation of LED lamps
- parallel connections of more RC circuits with lamps are possible
- 0,1 µF, 100 Ω, 250V~

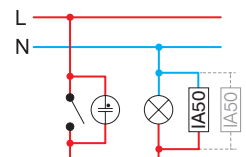

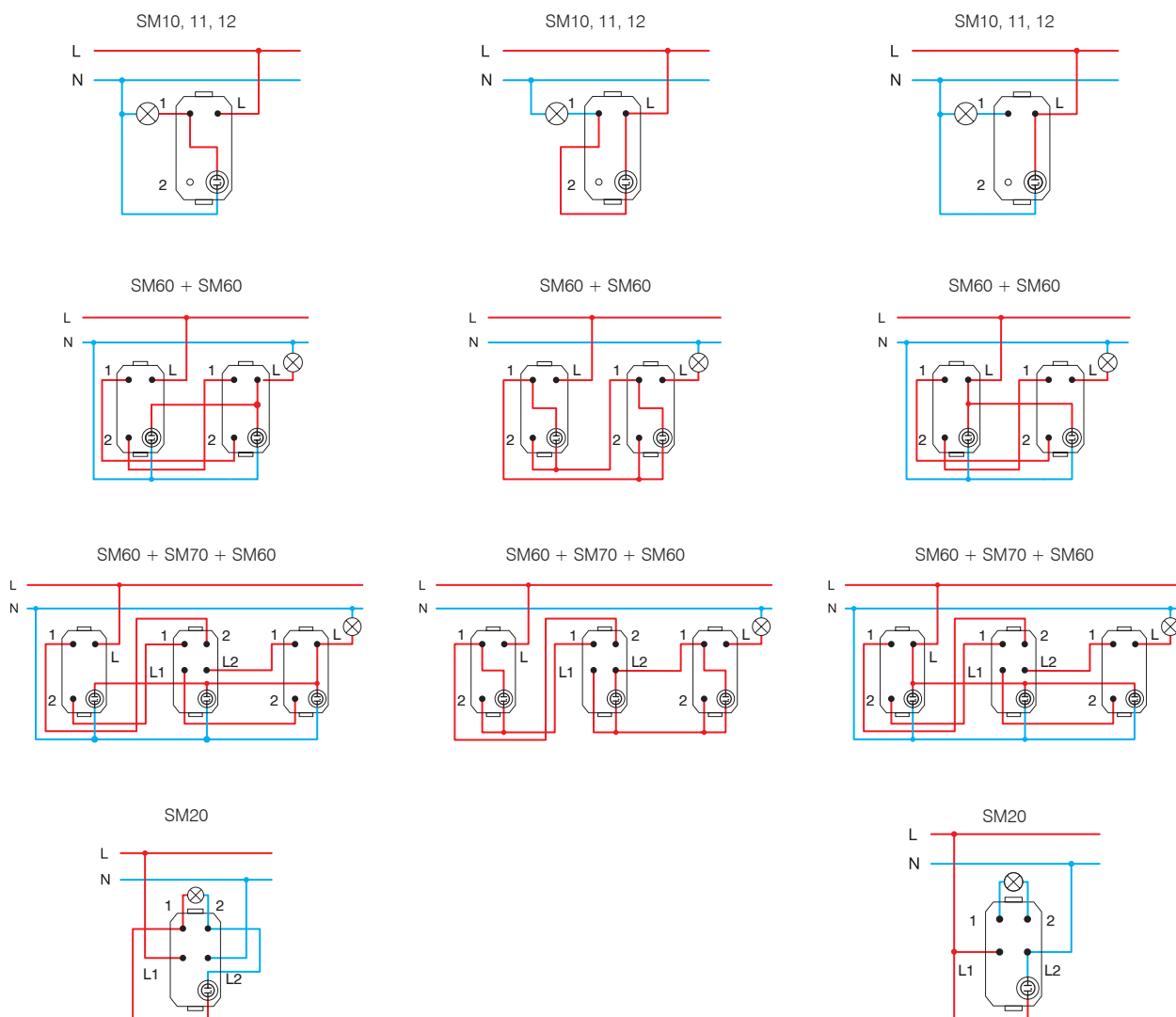

## I L L U M I N A T I O N I A

\* Indikacija /  
IndicationOsvetlitev /  
IlluminationStalna osvetlitev /  
Constant illumination

\* vezave primerne za varčne (CFL, LED) sijalke /  
wiring scheme for energy saving lamps (CFL, LED)

1M = 22,5 x 45  
2M = 45 x 45

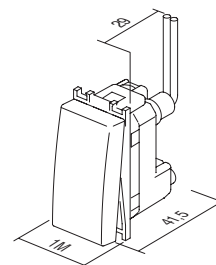

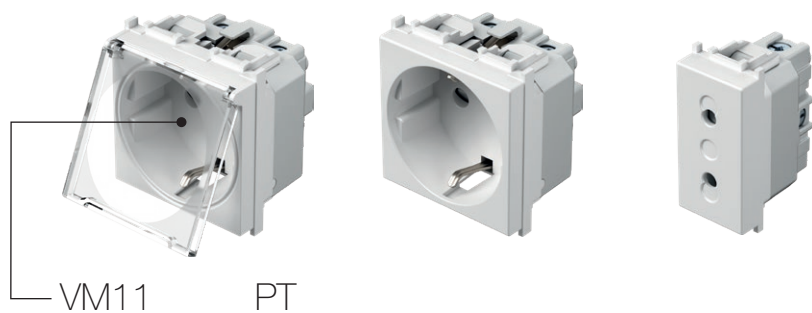

tip type	naziv description	tehnični opis technical data	velikost size	barva colour																																				
VM10	VTIČNICA SCHUKO+KS SOCKET SCHUKO+KS	2P+E 16A 250V~	2M	<table border="0"> <tr> <td><input type="checkbox"/> PW</td> <td>bela-sijaj polar white</td> <td><input checked="" type="checkbox"/> PT</td> <td>bela+prozorna white+transparent</td> <td><input type="checkbox"/> PP</td> <td>bela+bela white+white</td> </tr> </table>	<input type="checkbox"/> PW	bela-sijaj polar white	<input checked="" type="checkbox"/> PT	bela+prozorna white+transparent	<input type="checkbox"/> PP	bela+bela white+white																														
<input type="checkbox"/> PW	bela-sijaj polar white	<input checked="" type="checkbox"/> PT	bela+prozorna white+transparent	<input type="checkbox"/> PP	bela+bela white+white																																			
VM11	VTIČNICA SCHUKO+KS+POKROV SOCKET SCHUKO+KS+COVER	2P+E 16A 250V~	2M	<table border="0"> <tr> <td><input checked="" type="checkbox"/> SB</td> <td>črna-mat soft touch black</td> <td><input checked="" type="checkbox"/> BT</td> <td>črna+prozorna soft touch black+transparent</td> <td><input checked="" type="checkbox"/> BB</td> <td>črna+črna soft touch black+black</td> </tr> </table>	<input checked="" type="checkbox"/> SB	črna-mat soft touch black	<input checked="" type="checkbox"/> BT	črna+prozorna soft touch black+transparent	<input checked="" type="checkbox"/> BB	črna+črna soft touch black+black																														
<input checked="" type="checkbox"/> SB	črna-mat soft touch black	<input checked="" type="checkbox"/> BT	črna+prozorna soft touch black+transparent	<input checked="" type="checkbox"/> BB	črna+črna soft touch black+black																																			
VM20	VTIČNICA EURO+KS SOCKET EURO+KS	2P 10A 250V~	1M	<table border="0"> <tr> <td><input checked="" type="checkbox"/> AT</td> <td>antracit anthracite</td> <td><input checked="" type="checkbox"/> AT</td> <td>antracit+prozorna anthracite+transparent</td> <td><input checked="" type="checkbox"/> AA</td> <td>antracit+antracit anthracite+anthracite</td> </tr> <tr> <td><input type="checkbox"/> ES</td> <td>srebrna-mat elox silver</td> <td><input checked="" type="checkbox"/> ST</td> <td>srebrna+prozorna silver+transparent</td> <td><input type="checkbox"/> SS</td> <td>srebrna+srebrna silver+silver</td> </tr> <tr> <td><input type="checkbox"/> IW</td> <td>bež-sijaj ivory white</td> <td><input checked="" type="checkbox"/> IT</td> <td>bež+prozorna ivory+transparent</td> <td><input type="checkbox"/> II</td> <td>bež+bež ivory+ivory</td> </tr> <tr> <td><input checked="" type="checkbox"/> RD</td> <td>rdeča red</td> <td><input checked="" type="checkbox"/> RT</td> <td>rdeča+prozorna red+transparent</td> <td><input checked="" type="checkbox"/> RR</td> <td>rdeča+rdeča red+red</td> </tr> <tr> <td><input checked="" type="checkbox"/> GR</td> <td>zelena green</td> <td><input checked="" type="checkbox"/> GT</td> <td>zelena+prozorna green+transparent</td> <td><input checked="" type="checkbox"/> GG</td> <td>zelena+zelena green+green</td> </tr> <tr> <td><input checked="" type="checkbox"/> OR</td> <td>oranžna orange</td> <td><input checked="" type="checkbox"/> OT</td> <td>oranžna+prozorna orange+transparent</td> <td><input checked="" type="checkbox"/> OO</td> <td>oranžna+oranžna orange+orange</td> </tr> </table>	<input checked="" type="checkbox"/> AT	antracit anthracite	<input checked="" type="checkbox"/> AT	antracit+prozorna anthracite+transparent	<input checked="" type="checkbox"/> AA	antracit+antracit anthracite+anthracite	<input type="checkbox"/> ES	srebrna-mat elox silver	<input checked="" type="checkbox"/> ST	srebrna+prozorna silver+transparent	<input type="checkbox"/> SS	srebrna+srebrna silver+silver	<input type="checkbox"/> IW	bež-sijaj ivory white	<input checked="" type="checkbox"/> IT	bež+prozorna ivory+transparent	<input type="checkbox"/> II	bež+bež ivory+ivory	<input checked="" type="checkbox"/> RD	rdeča red	<input checked="" type="checkbox"/> RT	rdeča+prozorna red+transparent	<input checked="" type="checkbox"/> RR	rdeča+rdeča red+red	<input checked="" type="checkbox"/> GR	zelena green	<input checked="" type="checkbox"/> GT	zelena+prozorna green+transparent	<input checked="" type="checkbox"/> GG	zelena+zelena green+green	<input checked="" type="checkbox"/> OR	oranžna orange	<input checked="" type="checkbox"/> OT	oranžna+prozorna orange+transparent	<input checked="" type="checkbox"/> OO	oranžna+oranžna orange+orange
<input checked="" type="checkbox"/> AT	antracit anthracite	<input checked="" type="checkbox"/> AT	antracit+prozorna anthracite+transparent	<input checked="" type="checkbox"/> AA	antracit+antracit anthracite+anthracite																																			
<input type="checkbox"/> ES	srebrna-mat elox silver	<input checked="" type="checkbox"/> ST	srebrna+prozorna silver+transparent	<input type="checkbox"/> SS	srebrna+srebrna silver+silver																																			
<input type="checkbox"/> IW	bež-sijaj ivory white	<input checked="" type="checkbox"/> IT	bež+prozorna ivory+transparent	<input type="checkbox"/> II	bež+bež ivory+ivory																																			
<input checked="" type="checkbox"/> RD	rdeča red	<input checked="" type="checkbox"/> RT	rdeča+prozorna red+transparent	<input checked="" type="checkbox"/> RR	rdeča+rdeča red+red																																			
<input checked="" type="checkbox"/> GR	zelena green	<input checked="" type="checkbox"/> GT	zelena+prozorna green+transparent	<input checked="" type="checkbox"/> GG	zelena+zelena green+green																																			
<input checked="" type="checkbox"/> OR	oranžna orange	<input checked="" type="checkbox"/> OT	oranžna+prozorna orange+transparent	<input checked="" type="checkbox"/> OO	oranžna+oranžna orange+orange																																			

VTIČNICA SCHUKO+KS 2P+E 16A 250V~ 2M

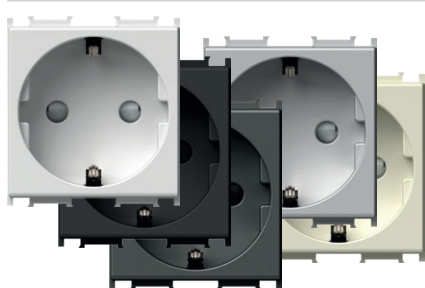

- VM10PW
- VM10SB
- VM10AT
- VM10ES
- VM10IW

- 2P+E schuko
- 16A 250V~, tip VM10
- ustreza IEC 60884-1, CEE7
- vijačna pritrditev vodnikov 1.5-2.5 mm<sup>2</sup>
- vgrajena zaščita pred dotikom kontaktov



SOCKET SCHUKO+KS 2P+E 16A 250V~ 2M

- 2P+E schuko
- 16A 250V~, type VM10
- in accordance with IEC 60884-1, CEE7
- screw contacts 1.5-2.5 mm<sup>2</sup>
- shuttered live contacts

VTIČNICA SCHUKO+KS 2P+E 16A 250V~ 2M

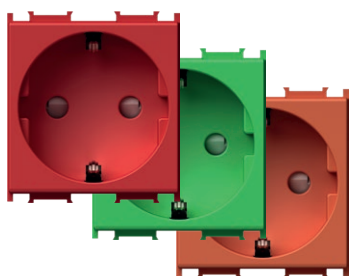

- VM10RD
- VM10GR
- VM10OR

- 2P+E schuko
- 16A 250V~, tip VM10
- ustreza IEC 60884-1, CEE7
- vijačna pritrditev vodnikov 1.5-2.5 mm<sup>2</sup>
- vgrajena zaščita pred dotikom kontaktov



SOCKET SCHUKO+KS 2P+E 16A 250V~ 2M

- 2P+E schuko
- 16A 250V~, type VM10
- in accordance with IEC 60884-1, CEE7
- screw contacts 1.5-2.5 mm<sup>2</sup>
- shuttered live contacts

VTIČNICA SCHUKO+KS+POKROV 2P+E 16A 250V~ 2M

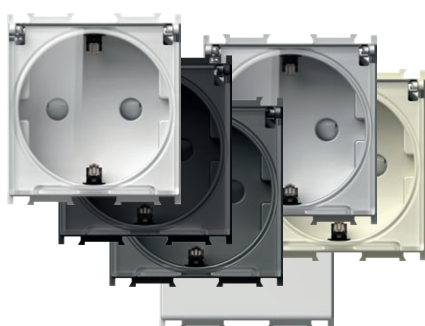

- VM11PT
- VM11BT
- VM11AT
- VM11ST
- VM11IT
- VM11PP

- 2P+E schuko+pokrov
- 16A 250V~, tip VM11
- ustreza IEC 60884-1, CEE7
- vijačna pritrditev vodnikov 1.5-2.5 mm<sup>2</sup>
- vgrajena zaščita pred dotikom kontaktov

SOCKET SCHUKO+KS+COVER  
2P+E 16A 250V~ 2M

- 2P+E schuko+cover
- 16A 250V~, type VM11
- in accordance with IEC 60884-1, CEE7
- screw contacts 1.5-2.5 mm<sup>2</sup>
- shuttered live contacts



**VTIČNICA EURO+KS 2P 10A 250V~ 1M**

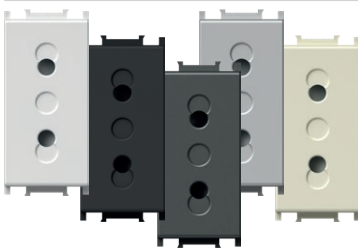

- VM20PW
- VM20SB
- VM20AT
- VM20ES
- VM20IW

- 2P euro
- 10A 250V~, tip VM20
- ustreza IEC 60884-1, CEE7
- vijačna pritrditev vodnikov 1.5-2.5 mm<sup>2</sup>
- vgrajena zaščita pred dotikom kontaktov



**SOCKET EURO+KS 2P 10A 250V~ 1M**

- 2P Euro
- 10A 250V~, type VM20
- in accordance with IEC 60884-1, CEE7
- screw contacts 1.5-2.5 mm<sup>2</sup>
- shuttered live contacts

**VTIČNICA FRANCOŠKA+KS 2P+E 16A 250V~ 2M**

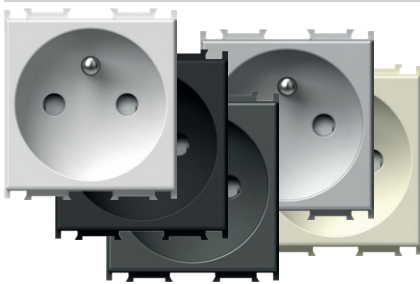

- VM40PW
- VM40SB
- VM40AT
- VM40ES
- VM40IW

- 2P+E francoska
- 16A 250V~, tip VM40
- ustreza IEC 60884-1, NF C 61-314, CEE7
- vijačna pritrditev vodnikov 1.5-2.5 mm<sup>2</sup>
- vgrajena zaščita pred dotikom kontaktov



**SOCKET FRENCH+KS 2P+E 16A 250V~ 2M**

- 2P+E French
- 16A 250V~, type VM40
- in accordance with IEC 60884-1, NF C 61-314, CEE7
- screw contacts 1.5-2.5 mm<sup>2</sup>
- shuttered live contacts

**VTIČNICA FRANCOŠKA+KS 2P+E 16A 250V~ 2M**

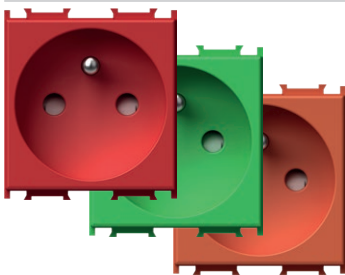

- VM40RD
- VM40GR
- VM40OR

- 2P+E francoska
- 16A 250V~, tip VM40
- ustreza IEC 60884-1, NF C 61-314, CEE7
- vijačna pritrditev vodnikov 1.5-2.5 mm<sup>2</sup>
- vgrajena zaščita pred dotikom kontaktov



**SOCKET FRENCH+KS 2P+E 16A 250V~ 2M**

- 2P+E French
- 16A 250V~, type VM40
- in accordance with IEC 60884-1, NF C 61-314, CEE7
- screw contacts 1.5-2.5 mm<sup>2</sup>
- shuttered live contacts

**VTIČNICA FRANCOŠKA+KS+POKROV 2P+E 16A 250V~ 2M**



- VM41PT
- VM41BT
- VM41AT
- VM41ST
- VM41IT

- 2P+E francoska+pokrov
- 16A 250V~, tip VM41
- ustreza IEC 60884-1, NF C 61-314, CEE7
- vijačna pritrditev vodnikov 1.5-2.5 mm<sup>2</sup>
- vgrajena zaščita pred dotikom kontaktov



**SOCKET FRENCH+KS+COVER**

- 2P+E 16A 250V~ 2M
- 2P+E French+cover
- 16A 250V~, type VM41
- in accordance with IEC 60884-1, NF C 61-314, CEE7
- screw contacts 1.5-2.5 mm<sup>2</sup>
- shuttered live contacts

**VTIČNICA ITALIJANSKA P17/11+KS 2P+E 16A 250V~ 1M**

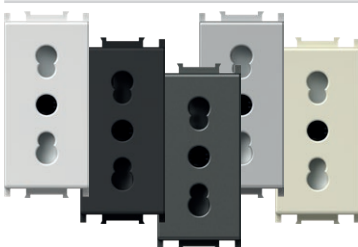

- VM30PW
- VM30SB
- VM30AT
- VM30ES
- VM30IW

- 2P+E italijanska P17/11
- 16A 250V~, tip VM30
- ustreza IEC 60884-1, CEI 23-50
- vijačna pritrditev vodnikov 1.5-2.5 mm<sup>2</sup>
- vgrajena zaščita pred dotikom kontaktov



**SOCKET ITALIAN P17/11+KS 2P+E 16A 250V~ 1M**

- 2P+E Italian P17/11
- 16A 250V~, type VM30
- in accordance with IEC 60884-1, CEI 23-50
- screw contacts 1.5-2.5 mm<sup>2</sup>
- shuttered live contacts

**VTIČNICA SCHUKO/ITA P17/11+KS 2P+E 16A 250V~ 2M**

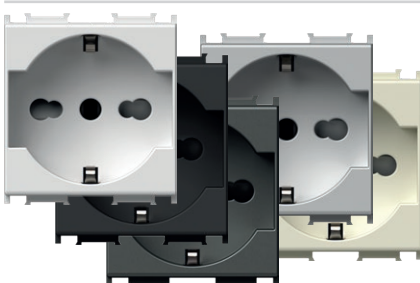

- VM31PW
- VM31SB
- VM31AT
- VM31ES
- VM31IW

- 2P+E schuko/italijanska P17/11
- 16A 250V~, tip VM31
- ustreza IEC 60884-1, CEI 23-50
- vijačna pritrditev vodnikov 1.5-2.5 mm<sup>2</sup>
- vgrajena zaščita pred dotikom kontaktov

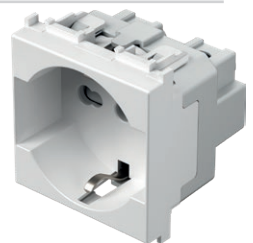

**SOCKET SCHUKO/ITA P17/11+KS**

- 2P+E 16A 250V~ 2M
- 2P+E schuko/Italian P17/11
- 16A 250V~, type VM31
- in accordance with IEC 60884-1, CEI 23-50
- screw contacts 1.5-2.5 mm<sup>2</sup>
- shuttered live contacts



VTIČNICA SCHUKO/ITA P30+KS 2P+E 16A 250V~ 2M

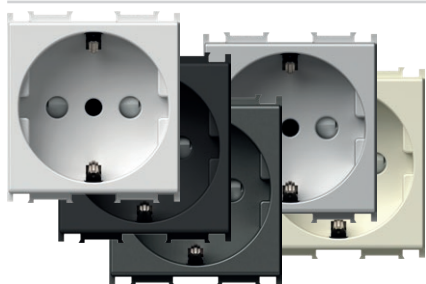

- VM32PW
- VM32SB
- VM32AT
- VM32ES
- VM32IW

- 2P+E schuko/italijanska P30
- 16A 250V~, tip VM32
- ustreza IEC 60884-1, CEI 23-50
- vijajčna pritrditev vodnikov 1.5-2.5 mm<sup>2</sup>
- vgrajena zaščita pred dotikom kontaktov



SOCKET SCHUKO/ITA P30+KS  
2P+E 16A 250V~ 2M

- 2P+E schuko/Italian P30
- 16A 250V~, type VM32
- in accordance with IEC 60884-1, CEI 23-50
- screw contacts 1.5-2.5 mm<sup>2</sup>
- shuttered live contacts

VTIČNICA ITALIJANSKA P11+KS 2P+E 10A 250V~ 1M

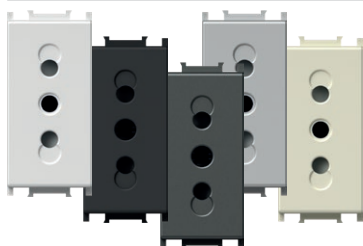

- VM33PW
- VM33SB
- VM33AT
- VM33ES
- VM33IW

- 2P+E italijanska P11
- 10A 250V~, tip VM33
- ustreza IEC 60884-1, CEI 23-50
- vijajčna pritrditev vodnikov 1.5-2.5 mm<sup>2</sup>
- vgrajena zaščita pred dotikom kontaktov



SOCKET ITALIAN P11+KS 2P+E 10A 250V~ 1M

- 2P+E Italian P11
- 10A 250V~, type VM33
- in accordance with IEC 60884-1, CEI 23-50
- screw contacts 1.5-2.5 mm<sup>2</sup>
- shuttered live contacts

VTIČNICA EURO/AMERIŠKA+KS 2P 16A 250V~ 1M

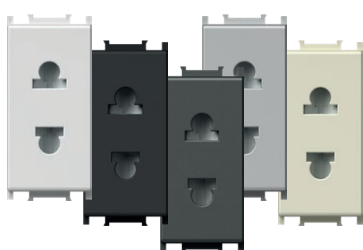

- VM21PW
- VM21SB
- VM21AT
- VM21ES
- VM21IW

- 2P euro/ameriška
- 16A 250V~, tip VM21
- vijajčna pritrditev vodnikov 1.5-2.5 mm<sup>2</sup>
- vgrajena zaščita pred dotikom kontaktov
- samo za države izven EU



SOCKET EURO/AMERICAN+KS 2P 16A 250V~ 1M

- 2P Euro/American
- 16A 250V~, type VM21
- screw contacts 1.5-2.5 mm<sup>2</sup>
- shuttered live contacts
- only for countries not members of EU

VTIČNICA BRITANSKA BS 546+KS 2P+E 15A 250V~ 2M

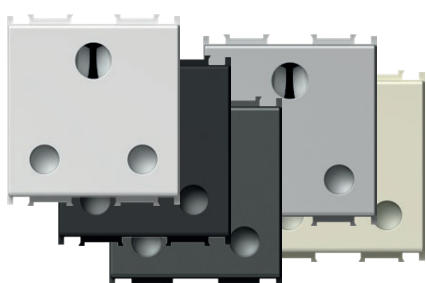

- VM51PW
- VM51SB
- VM51AT
- VM51ES
- VM51IW

- 2P+E britanski standard BS 546
- 15A 250V~, tip VM51
- ustreza BS 546
- vijajčna pritrditev vodnikov 1.5-4 mm<sup>2</sup>
- vgrajena zaščita pred dotikom kontaktov

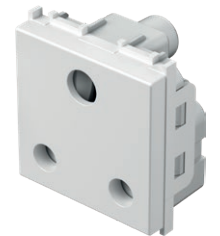

SOCKET BRITISH BS 546+KS 2P+E 15A 250V~ 2M

- 2P+E British BS 546
- 15A 250V~, type VM51
- in accordance with BS 546
- screw contacts 1.5-4 mm<sup>2</sup>
- shuttered live contacts

VTIČNICA BRITANSKA BS 1363-2+KS 2P+E 13A 250V~ 2M

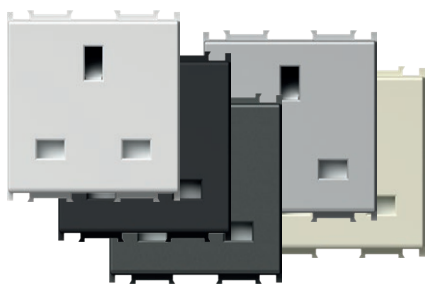

- VM52PW
- VM52SB
- VM52AT
- VM52ES
- VM52IW

- 2P+E britanski standard BS 1363-2
- 13A/250V~, tip VM52
- ustreza BS 1363-2
- vijajčna pritrditev vodnikov 1.5-4 mm<sup>2</sup>
- vgrajena zaščita pred dotikom kontaktov



SOCKET BRITISH BS 1363-2+KS 2P+E 13A 250V~ 2M

- 2P+E British BS 1363-2
- 13A 250V~, type VM52
- in accordance with BS 1363-2
- screw contacts 1.5-4 mm<sup>2</sup>
- shuttered live contacts

PRENAPETOSTNA ZAŠČITA MPE MINI 275V/50Hz



VM80

- vzporedna vezava s prvo vtičnico v seriji
- razred zaščite III
- U<sub>c</sub>=275Vac, U<sub>oc</sub>/I<sub>sc</sub>=6kV/3kA, U<sub>p</sub><800V
- ustreza IEC 61643-1
- vodniki 1.5mm<sup>2</sup>, IP20
- zvočni signal ob uničenju



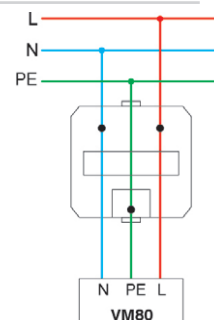

SURGE PROTECTOR MPE MINI 275V/50Hz

- parallel connection with the first socket in the row
- protection class III
- U<sub>c</sub>=275Vac, U<sub>oc</sub>/I<sub>sc</sub>=6kV/3kA, U<sub>p</sub><800V
- in accordance with IEC 61643-1
- wires 1.5mm<sup>2</sup>, IP20
- sound signal at breakdown





## S O C K E T S V M

UJEMANJE VTIČNIC IN VTIČEV  
SOCKETS AND PLUGS MATCHING

VTIČNICA / SOCKET	VM10 VM11	VM20	VM30	VM33	VM31	VM32	VM40 VM41	VM21
STIL VTIČA / PLUG STYLE								
nemški / German 	•				•	•		
francoski / French 	•				•	•	•	
italijanski / Italian S11 			•	•	•	•		
italijanski / Italian S17 			•	•	•			
euro 	•	•	•		•	•	•	•

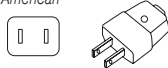
UJEMANJE VTIČNIC IN VTIČEV  
SOCKETS AND PLUGS MATCHING

VTIČNICA / SOCKET	VM21	VM51	VM52
STIL VTIČA / PLUG STYLE			
ameriški / American 	•		
britanski / British BS 546 		•	
britanski / British BS 1363-2 			•

1M = 22,5 x 45  
2M = 45 x 45

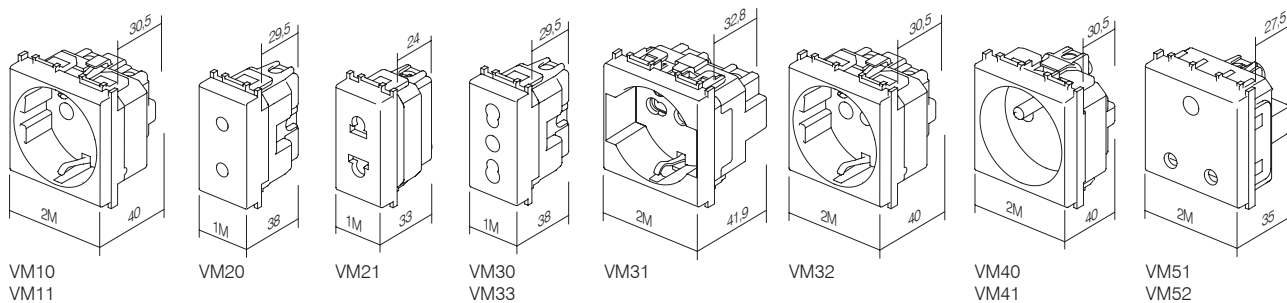



tip type	naziv description	tehnični opis technical data	velikost size	barva colour
KM10	VTIČNICA TV OSNOVNA SOCKET TV BASIC	0dB	1M	<input type="checkbox"/> PW bela-sijaj polar white
KM11	VTIČNICA TV KONČNA SOCKET TV END-LINE	1dB	1M	<input checked="" type="checkbox"/> SB črna-mat soft touch black
KM12	VTIČNICA TV PREHODNA SOCKET TV TROUGHPASS	10dB	1M	<input checked="" type="checkbox"/> AT antracit anthracite
⋮	⋮	⋮	⋮	<input type="checkbox"/> ES srebrna-mat elox silver
⋮	⋮	⋮	⋮	<input type="checkbox"/> IW bež-sijaj ivory white

VTIČNICA TV OSNOVNA 0dB 1M



- KM10PW
- KM10SB
- KM10AT
- KM10ES
- KM10IW

- TV osnovna
- dušenje 0dB
- konektor zadaj – F standard
- SOCKET TV BASIC 0dB 1M**
- TV basic
- reduction 0dB
- back connector – F standard



VTIČNICA TV OSNOVNA 0dB 2M

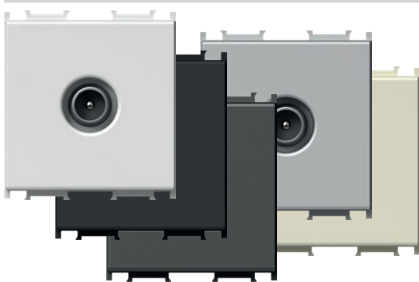

- KM20PW
- KM20SB
- KM20AT
- KM20ES
- KM20IW

- TV osnovna
- dušenje 0dB
- konektor zadaj – F standard
- SOCKET TV BASIC 0dB 2M**
- TV basic
- reduction 0dB
- back connector – F standard



VTIČNICA TV KONČNA 1dB 1M



- KM11PW
- KM11SB
- KM11AT
- KM11ES
- KM11IW

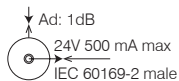

- TV končna
- frekvenčni pas 5÷2400 MHz
- dušenje < 1 dB
- ustreza EN 50083-1
- vijačna priključitev
- SOCKET TV END-LINE 1dB 1M**
- TV end-line
- frequency range 5÷2400 MHz
- reduction < 1 dB
- in accordance with EN 50083-1
- screw contacts



VTIČNICA TV PREHODNA 10dB 1M

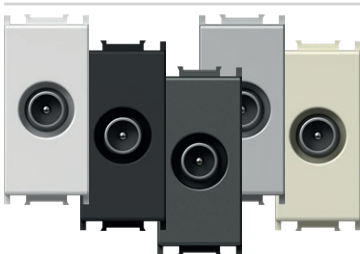

- KM12PW
- KM12SB
- KM12AT
- KM12ES
- KM12IW

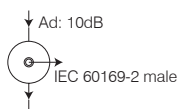

- TV prehodna
- frekvenčni pas 5÷2400 MHz
- dušenje < 10 dB
- ustreza EN 50083-1
- vijačna priključitev
- SOCKET TV TROUGHPASS 10dB 1M**
- TV troughpass
- frequency range 5÷2400 MHz
- reduction < 10 dB
- in accordance with EN 50083-1
- screw contacts





VTIČNICA SAT OSNOVNA 0dB 1M



- KM15PW
- KM15SB
- KM15AT
- KM15ES
- KM15IW

- SAT osnovna
- dušenje 0dB
- konektor zadaj – F standard
- SOCKET SAT BASIC 0dB 1M*
- SAT basic
- reduction 0dB
- back connector – F standard



VTIČNICA SAT OSNOVNA 0dB 2M



- KM24PW
- KM24SB
- KM24AT
- KM24ES
- KM24IW

- SAT osnovna
- dušenje 0dB
- konektor zadaj – F standard
- SOCKET SAT BASIC 0dB 2M*
- SAT basic
- reduction 0dB
- back connector – F standard



VTIČNICA SAT KONČNA 1dB 1M

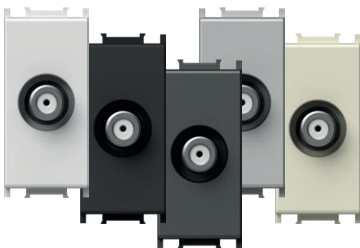

- KM16PW
- KM16SB
- KM16AT
- KM16ES
- KM16IW

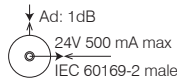

- SAT končna
- frekvenčni pas 5÷2400 MHz
- dušenje < 1dB
- ustreza EN 50083-1
- vijačna priključitev
- SOCKET SAT END-LINE 1dB 1M*
- SAT end-line
- frequency range 5÷2400 MHz
- reduction < 1dB
- in accordance with EN 50083-1
- screw contacts



VTIČNICA R OSNOVNA 0dB 1M



- KM19PW
- KM19SB
- KM19AT
- KM19ES
- KM19IW

- R osnovna
- dušenje 0dB
- konektor zadaj – F standard
- SOCKET R BASIC 0dB 1M*
- R basic
- reduction 0dB
- back connector – F standard



VTIČNICA R OSNOVNA 0dB 2M

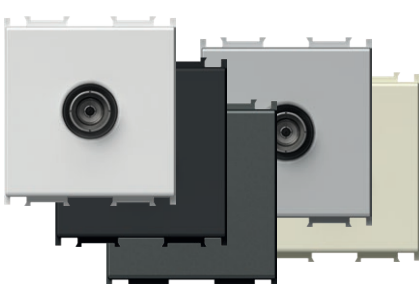

- KM29PW
- KM29SB
- KM29AT
- KM29ES
- KM29IW

- R osnovna
- dušenje 0dB
- konektor zadaj – F standard
- SOCKET R BASIC 0dB 2M*
- R basic
- reduction 0dB
- back connector – F standard



VTIČNICA SAT-TV KONČNA 1dB 2M



- KM25PW
- KM25SB
- KM25AT
- KM25ES
- KM25IW

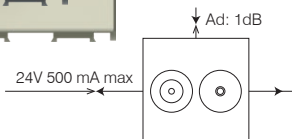

- SAT-TV končna
- frekvenčni pas 5÷2400 MHz
- dušenje < 1dB
- ustreza EN 50083-1
- vijačna priključitev
- SOCKET SAT-TV END-LINE 1dB 2M*
- SAT-TV end-line
- frequency range 5÷2400 MHz
- reduction < 1dB
- in accordance with EN 50083-1
- screw contacts



OSNOVNE VEZALNE SCHEME  
BASIC CONNECTION SAMPLES

samostojna vezava  
stand alone connection

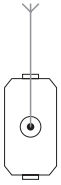

KM10  
KM20  
KM11  
KM15  
KM24  
KM16  
KM19  
KM29  
KM25

zvezda vezava  
star connection

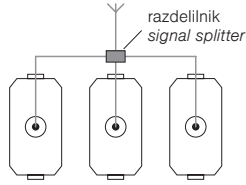

KM10  
KM20  
KM11  
KM15  
KM24  
KM16  
KM19  
KM29  
KM25

prehodna vezava  
throughpass connection

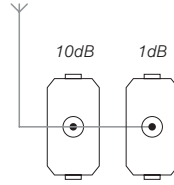

KM12 KM11



- KM22PW
- KM22SB
- KM22AT
- KM22ES
- KM22IW

VTIČNICA AVDIO 2xRCA 1M

- avdio 2x RCA
- pritrđitev vodnikov zadaj s spajkanjem

SOCKET AUDIO 2xRCA 1M

- audio 2x RCA
- soldering connection of cable at the back side



- KM23PW
- KM23SB
- KM23AT
- KM23ES
- KM23IW

VTIČNICA AVDIO ZVOČNIŠKA 1M

- avdio 2x Ø4mm
- za priklop zvočniškega vodnika, vtiča Ø4mm ali viličastega kabel čevlja
- pritrđitev vodnikov zadaj s spajkanjem

SOCKET AUDIO LOUDSPEAKERS 1M

- audio 2x Ø4mm
- to accommodate speaker wire, banana plug Ø4mm or spades
- soldering connection of cable at the back side



- KM26PW
- KM26SB
- KM26AT
- KM26ES
- KM26IW

VTIČNICA AVDIO ZVOČNIŠKA 2M

- avdio 2x Ø4mm
- za priklop zvočniškega vodnika, vtiča Ø4mm ali viličastega kabel čevlja
- pritrđitev vodnikov zadaj s spajkanjem

SOCKET AUDIO LOUDSPEAKERS 2M

- audio 2x Ø4mm
- to accommodate speaker wire, banana plug Ø4mm or spades
- soldering connection of cable at the back side



1M = 22,5 x 45  
2M = 45 x 45

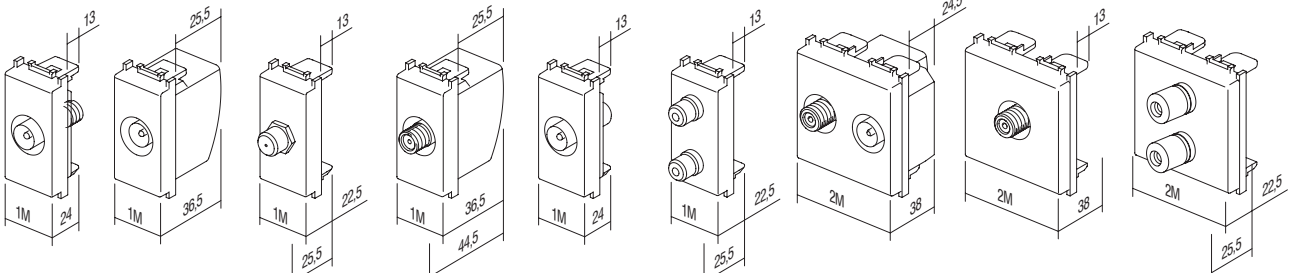

KM10

KM11  
KM12

KM15

KM16

KM19

KM22  
KM23

KM25

KM20  
KM24  
KM29

KM26

## VTIČNICA TEL LT RJ11 6/4 1M



- KM30PW
- KM30SB
- KM30AT
- KM30ES
- KM30IW

- TEL LT vijak
- RJ11 6/4
- ustreza IEC 60603-7
- vijačna pritrditev vodnikov

*SOCKET TEL LT RJ11 6/4 1M*

- TEL LT screw
- RJ11 6/4
- in accordance with IEC 60603-7
- screw contacts



## VTIČNICA TEL BT SEC 6/6 1M

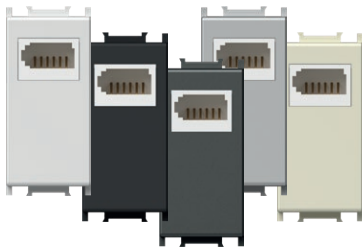

- KM31PW
- KM31SB
- KM31AT
- KM31ES
- KM31IW

- TEL BT britanski standard
- SEC sekundarna 6/6
- ustreza BS 6312
- vijačna pritrditev vodnikov

*SOCKET TEL BT SEC 6/6 1M*

- TEL BT British standard
- SEC secondary 6/6
- in accordance with BS 6312
- screw contacts



## VTIČNICA TEL KS RJ11 6/4 1M

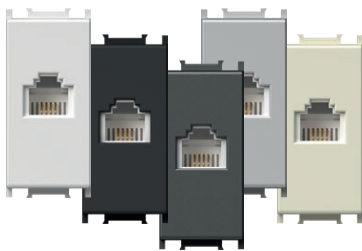

- KM36PW
- KM36SB
- KM36AT
- KM36ES
- KM36IW

- KS keystone pritrditveni standard
- RJ11 6/4
- ustreza IEC 60603-7

*SOCKET TEL KS RJ11 6/4 1M*

- KS keystone fixing standard
- RJ11 6/4
- in accordance with IEC 60603-7

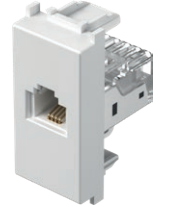

## VTIČNICA CAT5e KS RJ45 8/8 1M

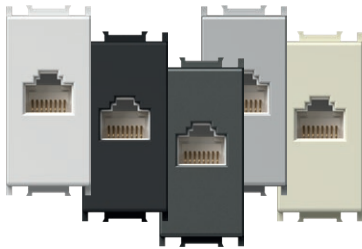

- KM37PW
- KM37SB
- KM37AT
- KM37ES
- KM37IW

- KS keystone pritrditveni standard
- CAT5e, RJ45 8/8
- ustreza IEC 60603-7

*SOCKET CAT5e KS RJ45 8/8 1M*

- KS keystone fixing standard
- CAT5e, RJ45 8/8
- in accordance with IEC 60603-7

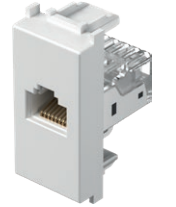

## ADAPTER KS 1M

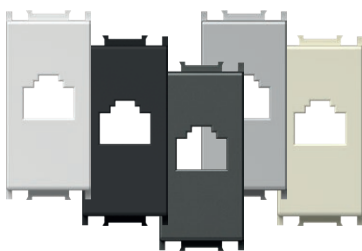

- KM35PW
- KM35SB
- KM35AT
- KM35ES
- KM35IW

- KS keystone pritrditveni standard
- AMP, Avaya, Brandrex, FMT, Mfico, Tyco, ...
- komunikacijski modul ni vgrajen

*ADAPTER KS 1M*

- KS keystone fixing standard
- AMP, Avaya, Brandrex, FMT, Mfico, Tyco, ...
- communication module not included



## ADAPTER KS S PRAŠNO ZAŠČITO 1M



- KM38PW
- KM38SB
- KM38AT
- KM38ES
- KM38IW

- KS keystone pritrditveni standard s protiprašnim pokrovom
- AMP, Avaya, Brandrex, FMT, Mfico, Tyco, ...
- komunikacijski modul ni vgrajen

*ADAPTER KS WITH DUST PROTECTION 1M*

- KS keystone fixing standard with dust protection
- AMP, Avaya, Brandrex, FMT, Mfico, Tyco, ...
- communication module not included





VTIČNICA CAT6 SCH KS RJ45 8/8 1M

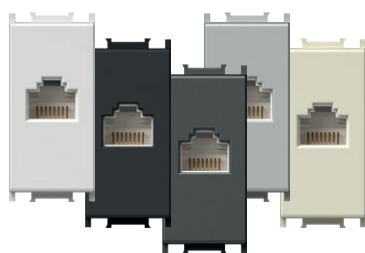

- KM39PW
- KM39SB
- KM39AT
- KM39ES
- KM39IW

- KS keystone pritrditveni standard  
 - CAT6 UTP toolless, RJ45 8/8  
 - ustreza ISO/IEC 11801

*SOCKET CAT6 SCH KS RJ45 8/8 1M*

- KS keystone fixing standard  
 - CAT6 UTP toolless, RJ45 8/8  
 - in accordance with ISO/IEC 11801



ADAPTER KS UNIVERZALNI 1M

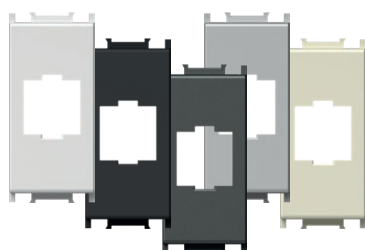

- KM50PW
- KM50SB
- KM50AT
- KM50ES
- KM50IW

- KS keystone pritrditveni standard  
 - primeren za HDMI, USB  
 - komunikacijski modul ni vgrajen

*ADAPTER KS UNIVERSAL 1M*

- KS keystone fixing standard  
 - suitable for HDMI, USB  
 - communication module not included

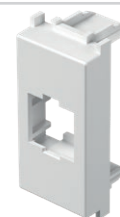

ADAPTER PD 1M

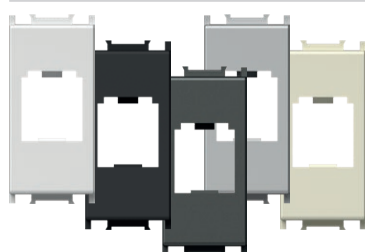

- KM40PW
- KM40SB
- KM40AT
- KM40ES
- KM40IW

- PD Panduit Mini-COM pritrditveni standard  
 - komunikacijski modul ni vgrajen

*ADAPTER PD 1M*

- PD Panduit Mini-COM fixing standard  
 - communication module not included



ADAPTER PD S PRAŠNO ZAŠČITO 1M



- KM43PW
- KM43SB
- KM43AT
- KM43ES
- KM43IW

- PD Panduit Mini-COM pritrditveni standard s protiprašnim pokrovom  
 - komunikacijski modul ni vgrajen

*ADAPTER PD WITH DUST PROTECTION 1M*

- PD Panduit Mini-COM fixing standard with dust protection  
 - communication module not included



ADAPTER R&M 1M

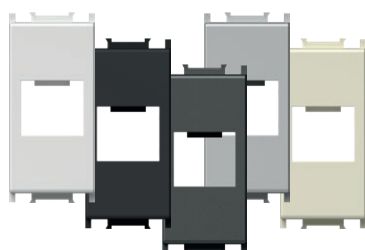

- KM46PW
- KM46SB
- KM46AT
- KM46ES
- KM46IW

- R&M pritrditveni standard  
 - komunikacijski modul ni vgrajen

*ADAPTER R&M 1M*

- R&M fixing standard  
 - communication module not included



ADAPTER R&M CAT6A 1M

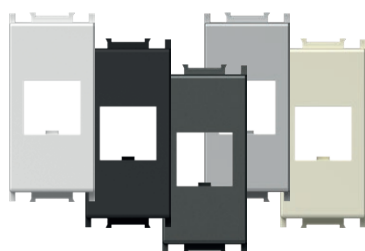

- KM52PW
- KM52SB
- KM52AT
- KM52ES
- KM52IW

- R&M pritrditev za CAT6A  
 - komunikacijski modul ni vgrajen

*ADAPTER R&M CAT6A 1M*

- R&M fixing for CAT6A  
 - communication module not included





- KM47PW
- KM47SB
- KM47AT
- KM47ES
- KM47IW

#### ADAPTER R&M S PRAŠNO ZAŠČITO 1M

- R&M pritrditveni standard s protiprašnim pokrovom
- komunikacijski modul ni vgrajen

#### ADAPTER R&M WITH DUST PROTECTION 1M

- R&M fixing standard with dust protection
- communication module not included



- KM53PW
- KM53SB
- KM53AT
- KM53ES
- KM53IW

#### ADAPTER R&M CAT6A S PRAŠNO ZAŠČITO 1M

- R&M pritrditev za CAT6A s protiprašnim pokrovom
- komunikacijski modul ni vgrajen

#### ADAPTER R&M CAT6A WITH DUST PROTECTION 1M

- R&M fixing for CAT6A with dust protection
- communication module not included



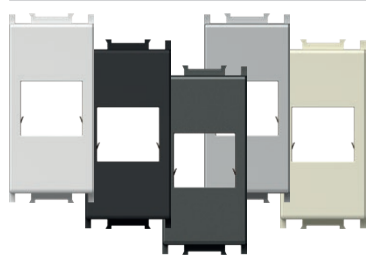

- KM45PW
- KM45SB
- KM45AT
- KM45ES
- KM45IW

#### ADAPTER LK 1M

- LK LeoniKerpen eLine / BKS NewLine pritrditveni standard  
- komunikacijski modul ni vgrajen

#### ADAPTER LK 1M

- LK LeoniKerpen eLine / BKS NewLine fixing standard  
- communication module not included

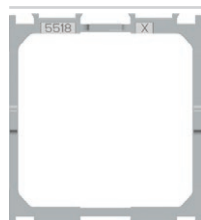

KA26

#### ADAPTER NEXANS/SCHRACK 2M

- adapter za pritrditev modulov Nexans LANmark in Schrack velikosti 45x45mm  
- primerna za Nexans tip N423.540N  
- primeren za Schrack tip HSEMD02W2F  
- komunikacijski modul ni vgrajen

#### ADAPTER NEXANS/SCHRACK 2M

- fixing adapter for Nexans LANmark and Schrack module 45x45mm  
- suitable for Nexans type N423.540N  
- suitable for Schrack type HSEMD02W2F  
- communication module not included

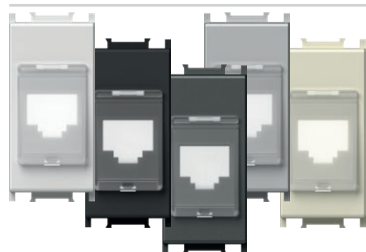
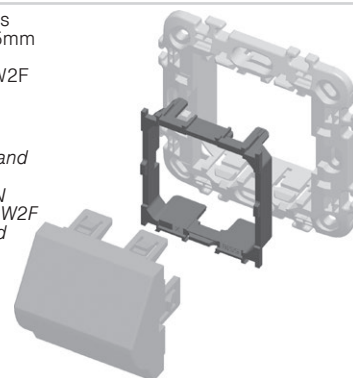

- KM48PW
- KM48SB
- KM48AT
- KM48ES
- KM48IW

#### ADAPTER AT&T SYSTIMAX S PRAŠNO ZAŠČITO 1M

- AT&T Systimax pritrditveni standard s protiprašnim pokrovom  
- komunikacijski modul ni vgrajen

#### ADAPTER AT&T SYSTIMAX WITH DUST PROTECTION 1M

- AT&T Systimax fixing standard with dust protection  
- communication module not included



- KM51PW
- KM51SB
- KM51AT
- KM51ES
- KM51IW

#### VTIČNICA USB TIP A 1M

- USB 2.0 vtičnica tip A  
- vijačna pritrditev vodnikov, raster 5 mm, 1,5 mm<sup>2</sup>, 1x2P + 1x3P  
- ožičenje:  
PIN 1 - VCC (+5V, rdeča žica)  
PIN 2 - signal - (bela žica)  
PIN 3 - signal + (zelená žica)  
PIN 4 - GND - masa (črna žica)  
S - oklop  
- ustreza direktivi 2011/95/EU (RoHS2)

#### SOCKET USB TYPE A 1M

- USB 2.0 socket type A  
- screw contacts, raster 5 mm, 1,5 mm<sup>2</sup>, 1x2P + 1x3P  
- wiring:  
PIN 1 - VCC (+5V, red wire)  
PIN 2 - Data - (white wire)  
PIN 3 - Data + (green wire)  
PIN 4 - GND - ground (black wire)  
S - shield  
- in accordance with directive 2011/95/EU (RoHS2)



1M = 22,5 x 45  
2M = 45 x 45

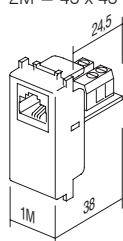

KM30

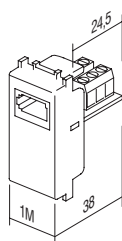

KM31

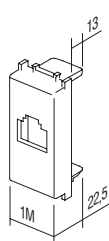

KM35  
KM38  
KM48

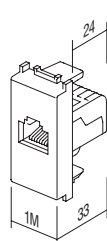

KM36  
KM37  
KM39

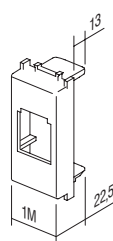

KM40  
KM43

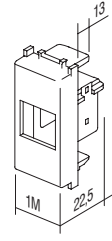

KM45

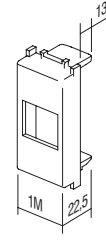

KM46  
KM47  
KM50  
KM52  
KM53

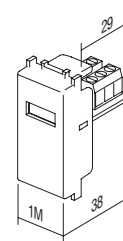

KM51





KA10

tip type	naziv description	tehnični opis technical data
KA10	KONEKTOR KS CAT3 CONNECTOR KS CAT3	RJ11 6/4
KA11	KONEKTOR KS CAT5e CONNECTOR KS CAT5e	RJ45 8/8
KA12	KONEKTOR KS CAT5eS CONNECTOR KS CAT5eS	RJ45 8/8
⋮	⋮	⋮
⋮	⋮	⋮

## KONEKTOR KS CAT3 RJ11 6/4



KA10	- KS keystone pritrditveni standard - CAT3, RJ11 6/4 - ustreza IEC 60603-7 <i>CONNECTOR KS CAT3 RJ11 6/4</i> - KS keystone fixing standard - CAT3, RJ11 6/4 - in accordance with IEC 60603-7
------	--

## KONEKTOR KS CAT5e RJ45 8/8



KA11	- KS keystone pritrditveni standard - CAT5e, RJ45 8/8 - ustreza IEC 60603-7 <i>CONNECTOR KS CAT5e RJ45 8/8</i> - KS keystone fixing standard - CAT5e, RJ45 8/8 - in accordance with IEC 60603-7
------	---

## KONEKTOR KS CAT5eS RJ45 8/8



KA12	- KS keystone pritrditveni standard - CAT5eS, RJ45 8/8 - ustreza IEC 60603-7 <i>CONNECTOR KS CAT5eS RJ45 8/8</i> - KS keystone fixing standard - CAT5eS, RJ45 8/8 - in accordance with IEC 60603-7
------	--

## KONEKTOR KS CAT6 SCH RJ45 8/8



KA15	- KS keystone pritrditveni standard - CAT6 UTP toolless, RJ45 8/8 - ustreza ISO/IEC 11801 <i>CONNECTOR KS CAT6 SCH RJ45 8/8</i> - KS keystone fixing standard - CAT6 UTP toolless, RJ45 8/8 - in accordance with ISO/IEC 11801
------	--

## KONEKTOR KS CAT6S SCH RJ45 8/8



KA16	- KS keystone pritrditveni standard - CAT6S STP toolless, RJ45 8/8 - ustreza ISO/IEC 11801 <i>CONNECTOR KS CAT6S SCH RJ45 8/8</i> - KS keystone fixing standard - CAT6S STP toolless, RJ45 8/8 - in accordance with ISO/IEC 11801
------	---

## KONEKTOR KS CAT6a SCH RJ45 8/8



KA17	- KS keystone pritrditveni standard - CAT6a STP toolless, RJ45 8/8 - ustreza ISO/IEC 11801 <i>CONNECTOR KS CAT6a SCH RJ45 8/8</i> - KS keystone fixing standard - CAT6a STP toolless, RJ45 8/8 - in accordance with ISO/IEC 11801
------	---



KA18

**KONEKTOR SLIM KS CAT6S SCH RJ45 8/8**

- KS keystone pritrditveni standard
- slim verzija
- CAT6S STP toolless, RJ45 8/8
- ustreza ISO/IEC 11801
- primeren tudi za dvojni adapter KE46

*CONNECTOR SLIM KS CAT6S SCH RJ45 8/8*

- KS keystone fixing standard
- slim style
- CAT6S STP toolless, RJ45 8/8
- in accordance with ISO/IEC 11801
- suitable also for KE46 double adapter



KA27

**KONEKTOR KS HDMI**

- KS keystone pritrditveni standard
- samo v kombinaciji z adapterjem KM50
- HDMI/HDMI

*CONNECTOR KS HDMI*

- KS keystone fixing standard
- only in combination with adapter KM50
- HDMI/HDMI



KA28

**KABEL KS HDMI**

- KS keystone pritrditveni standard
- samo v kombinaciji z adapterjem KM50
- HDMI/HDMI

*CABLE KS HDMI*

- KS keystone fixing standard
- only in combination with adapter KM50
- HDMI/HDMI



tip type	naziv description	tehnični opis technical data	velikost size	barva colour
EM10	ZATEMNILNIK ROTACIJSKI <i>DIMMER ROTATIVE</i>	R 300W	1M	<input type="checkbox"/> PW bela-sijaj <i>polar white</i>
EM12	ZATEMNILNIK ROTACIJSKI MENJALNI <i>DIMMER ROTATIVE 2WAY</i>	RL 300W	1M	<input checked="" type="checkbox"/> SB črna-mat <i>soft touch black</i>
EM23	ZATEMNILNIK VGRADNI <i>DIMMER INBOX</i>	RC,RL 200VA	/	<input checked="" type="checkbox"/> AT antracit <i>anthracite</i>
·	·	·	·	<input type="checkbox"/> ES srebrna-mat <i>elox silver</i>
·	·	·	·	<input type="checkbox"/> IW bež-sijaj <i>ivory white</i>
·	·	·	·	<input type="checkbox"/> BL modra <i>blue</i>
·	·	·	·	<input type="checkbox"/> RD rdeča <i>red</i>
·	·	·	·	<input type="checkbox"/> GR zelena <i>green</i>
·	·	·	·	<input type="checkbox"/> OR oranžna <i>orange</i>
·	·	·	·	<input type="checkbox"/> RG rdeča/zelena <i>red/green</i>

#### ZATEMNILNIK ROTACIJSKI R 300W 1M



- EM10PW
- EM10SB
- EM10AT
- EM10ES
- EM10IW

- rotacijski brez stikala
- tip RTS34.43 RVP, breme R, 40W - 300W
- napajanje 230V~ 50Hz
- vezava z menjalnim stikalom ni možna
- vezava večih zatemnilnikov ni dovoljena
- ustreza EN 60669-1
- vijačna pritrditev vodnikov 1.5-2.5 mm<sup>2</sup>
- LED indikacija

#### DIMMER ROTATIVE R 300W 1M

- rotation control without switch
- type RTS34, 43 RVP, load R, 40W - 300W
- supply voltage 230V~ 50Hz
- 2-way switch combination is not possible
- more dimmers combination is not allowed
- in accordance with EN 60669-1
- screw contacts 1.5-2.5mm<sup>2</sup>
- LED indication



#### ZATEMNILNIK ROTACIJSKI/MENJALNI RL 300 W 1M



- EM12PW
- EM12SB
- EM12AT
- EM12ES
- EM12IW

- rotacijski z menjalnim stikalom
- breme RL, 40W - 300W
- napajanje 230V~ 50Hz
- možna vezava z menjalnim stikalom
- montaža več naprav skupaj v eno dozo dovoljena samo pod pogojem, da njihovo skupno maksimalno breme ne presega maksimalne moči enega zatemnilnika
- v istem tokokrogu je dovoljena uporaba samo enega zatemnilnega stikala
- varovalka ni vgrajena - potrebna vezava zunanje varovalke
- ustreza EN 60669-1
- vijačni kontakti - 1.5÷2.5mm<sup>2</sup>
- vgrajena LED indikacija stopnje zatemnitve

#### DIMMER ROTATIVE/2WAY RL 300W 1M

- rotation control with 2-way switch
- load RL, 40W - 300W
- supply voltage 230V~ 50Hz
- 2-way switch combination is possible
- installing several devices together in one box is only permitted if their total maximum load does not exceed the maximum power of a single dimmer
- one circuit allows the use of only one dimmer
- no built-in fuse - external fuse must be used
- in accordance with EN 60669-1
- screw contacts - 1.5-2.5mm<sup>2</sup>
- integrated LED indication of dimming level

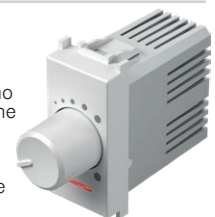





- EM13PW
- EM13SB
- EM13AT
- EM13ES
- EM13IW

#### ZATEMNLNIK ROTACIJSKI/MENJALNI LED 60 W 1M

- rotacijski z menjalnim stikalom
- bremena: LED, 0 – 60 W (max. 6 LED zatemnilnih sijalk)  
GLS, 0 – 60 W
- napajanje 230V~ 50Hz
- možna vezava z menjalnim stikalom
- montaža več naprav skupaj v eno dozo dovoljena samo pod pogojem, da njihovo skupno maksimalno breme ne presega maksimalne moči enega zatemnilnika
- v istem tokokrogu je dovoljena uporaba samo enega zatemnilnega stikala
- varovalka ni vgrajena – potrebna vezava zunanje varovalke
- ustreza IEC60669-2-1
- vijačni kontakti - 1.5÷2.5mm<sup>2</sup>

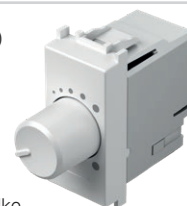

#### DIMMER ROTATIVE/2WAY LED 60W 1M

- rotation control with 2-way switch
- loads: LED, 0 – 60W (max. 6 dimmable LED lamps)  
GLS, 0 – 60W
- supply voltage 230V~ 50Hz
- 2-way switch combination is possible
- installing several devices together in one box is only permitted if their total maximum load does not exceed the maximum power of a single dimmer
- one circuit allows the use of only one dimmer
- no built-in fuse – external fuse must be used
- in accordance with IEC60669-2-1
- screw contacts - 1.5-2.5mm<sup>2</sup>



- EM14PW
- EM14SB
- EM14AT
- EM14ES
- EM14IW

#### ZATEMNLNIK ROTACIJSKI/MENJALNI LED 180 W 1M

- rotacijski z menjalnim stikalom
- bremena:  
LED, 0 – 180 W (max. 20 LED zatemnilnih sijalk)  
GLS, 0 – 180 W
- napajanje 230V~ 50Hz
- možna vezava z menjalnim stikalom
- montaža več naprav skupaj v eno dozo dovoljena samo pod pogojem, da njihovo skupno maksimalno breme ne presega maksimalne moči enega zatemnilnika
- v istem tokokrogu je dovoljena uporaba samo enega zatemnilnega stikala
- varovalka ni vgrajena – potrebna vezava zunanje varovalke
- ustreza IEC60669-2-1
- vijačni kontakti - 1.5÷2.5mm<sup>2</sup>



#### DIMMER ROTATIVE/2WAY LED 180W 1M

- rotation control with 2-way switch
- loads:  
LED, 0 – 180W (max. 20 dimmable LED lamps)  
GLS, 0 – 180W
- supply voltage 230V~ 50Hz
- 2-way switch combination is possible
- installing several devices together in one box is only permitted if their total maximum load does not exceed the maximum power of a single dimmer
- one circuit allows the use of only one dimmer
- no built-in fuse – external fuse must be used
- in accordance with IEC60669-2-1
- screw contacts - 1.5-2.5mm<sup>2</sup>



- EM15PW
- EM15SB
- EM15AT
- EM15ES
- EM15IW

#### ZATEMNLNIK ROTACIJSKI R 250W 1M

- rotacijski brez stikala
- tip RTS34.43 RVP, breme R, 40W - 250W
- napajanje 230V~ 50Hz
- vezava z menjalnim stikalom ni možna
- vezava večih zatemnilnikov ni dovoljena
- ustreza EN 60669-1
- vijačna pritrditev vodnikov 1.5-2.5 mm<sup>2</sup>
- LED indikacija

#### DIMMER ROTATIVE R 250W 1M

- rotation control without switch
- type RTS34, 43 RVP, load R, 40W - 250W
- supply voltage 230V~ 50Hz
- 2-way switch combination is not possible
- more dimmers combination is not allowed
- in accordance with EN 60669-1
- screw contacts 1.5-2.5mm<sup>2</sup>
- LED indication





EM23

**ZATEMNILNIK VGRADNI R (250 W), (RC,RL 200VA)**

- vgradni, za vezavo s tipkalom
- breme RLC 15-250W ali 15-200 VA
- napajanje 230 V $\sim$  50HZ
- možna vezava več tipkal
- vezava več zatemnilnikov ni dovoljena
- vgrajena spominska funkcija
- funkcija mehkega vklopa/izklopa
- »leading edge«
- ustreza EN60669, EN60950, EN 61000, ETSI EN 300 220-1, ETSI EN 300 220-2
- vijačna pritrditev vodnikov do preseka 2,5mm<sup>2</sup>

**DIMMER INBOX R (250 W), (RC, RL 200 VA)**

- inbox, controlled by external push button
- load RLC 15-250W or 15-200 VA
- supply voltage 230V $\sim$  50HZ
- several push-buttons combinations are possible
- more dimmers combination is not allowed
- light intensity memory
- soft start/stop function
- »leading edge«
- in accordance with EN60669, EN60950, EN 61000, ETSI EN 300 220-1, ETSI EN 300 220-2
- screw contacts to wires 2,5 mm<sup>2</sup>



EM18

**ZATEMNILNIK VGRADNI LED 250W**

- vgradni, za vezavo s tipkalom
- za leading ali trailing edge
- napajanje 230 V $\sim$  50 Hz
- možna vezava z več tipkali
- vgrajena spominska funkcija
- funkcija mehkega vklopa/izklopa
- nastavev minimalne svetilnosti
- montaža samo ene naprave v eno dozo
- samo za notranjo uporabo
- ustreza EN 60669-1 in EN 60669-2-1

**DIMMER INBOX LED 250W**

- inbox, controlled by external push button
- for leading or trailing edge
- supply voltage 230V $\sim$  50Hz
- several push-buttons combinations is possible
- light intensity memory
- soft start / stop function
- minimum intensity control
- only one dimmer per wall box
- only for indoor usage
- in accordance with EN 60669-1 and EN 60669-2-1



EM19

**ZATEMNILNIK VGRADNI DC LED 96W**

- vgradni, za vezavo s tipkalom
- vezava z vsemi LED napajalniki s konstantno napetostjo in nekaterimi LED napajalniki s konstantnim tokom, 9 – 48V DC, max 96W (tudi za LED trakove)
- ni za uporabo z induktivnimi bremenimi
- možna vezava z več tipkali in več zatemnilniki
- vgrajena spominska funkcija
- funkcija mehkega vklopa / izklopa
- montaža samo ene naprave v eno dozo
- samo za notranjo uporabo

**DIMMER INBOX DC LED 96W**

- inbox, controlled by external push button
- for use with constant voltage LED drivers and some constant current LED drivers, 9-48V DC, max 96W (also for LED strips)
- not for use with inductive loads
- several push-buttons combinations and several dimmers is possible
- light intensity memory
- soft start / stop function
- only one dimmer per wall box
- only for indoor usage

EM10 (40÷300W)  
EM15 (40÷300W)

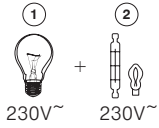

EM12 (40÷300W)

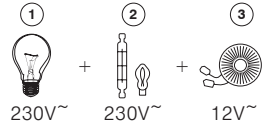

EM13 (0÷60W), EM14 (0÷180W),  
EM23 (15÷250W, 15÷200VA),  
EM18 (2÷250VA (3=10÷250VA), 2÷250W)

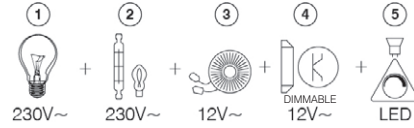

- 1 - žarnica z žarilno nitko / incandescent lamp
- 2 - halogenska žarnica / halogen lamp
- 3 - klasični transformator / classical transformer
- 4 - zatemnilni elektronski transformator / dimmable electronic transformer
- 5 - zatemnilna LED sijalka / dimmable LED lamp

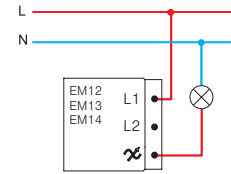
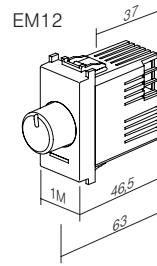
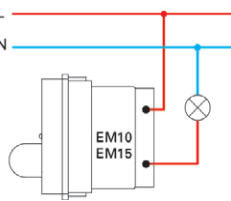
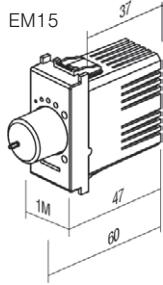
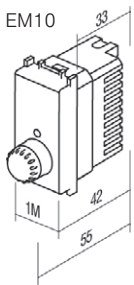

EM23

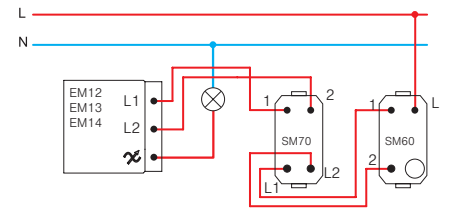
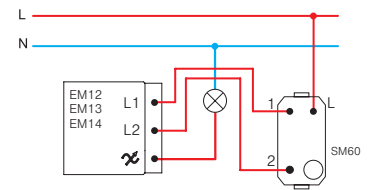
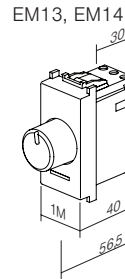
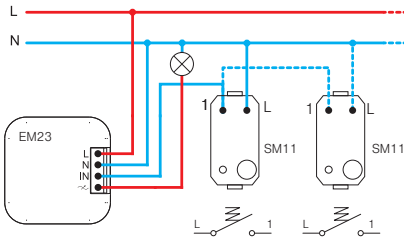
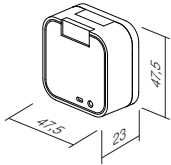

EM18

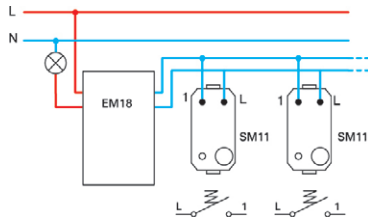
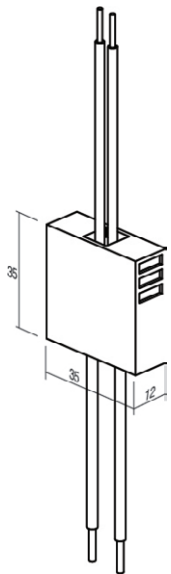

EM19

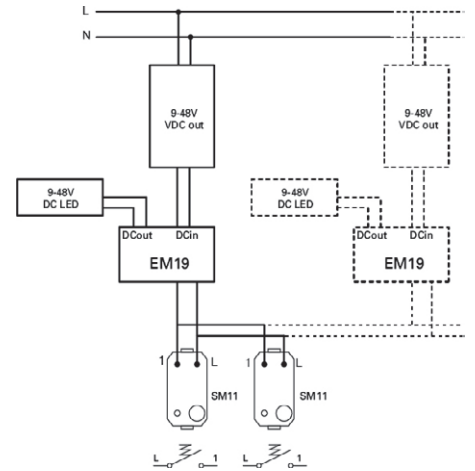
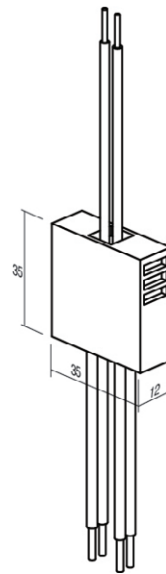

**POZOR!**

V primeru montaže več zatemnilnih stikal v isto dozo se za vsako dodatno zatemnilno stikalo zmanjša maksimalna skupna moč za 10%.

**ATTENTION!**

If more dimmers are connected in one box reduce maximum common power for 10% for each dimmer.

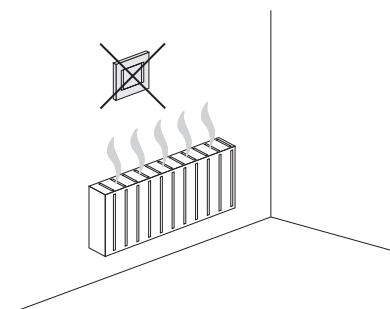

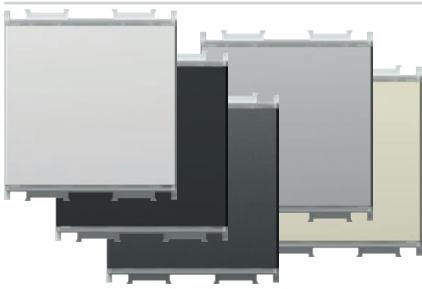

- EM25PW
- EM25SB
- EM25AT
- EM25ES
- EM25IW

STIKALO / ZATEMNILNIK UNIVERZALNI RLC 0-300W 2M

- univerzalni elektronski zatemnilnik za vklop, izklop in zatemnjevanje vseh zatemnilnih žarnic in sijalk (klasične, halogenske, LED, CFL, ...)
- in nekaterih nezatemnilnih sijalk
- samodejno zazna vrsto sijalke in temu prilagodi režim delovanja
- z zatemnjevanjem se zmanjša poraba električne energije
- funkcija mehkega zagona podaljša življenjsko dobo sijalk
- upravljanje preko vgrajenih mikro-stikal
- vgrajena spominska funkcija - ob izklopu si zapomni nivo zatemnitve
- možna vezava do pet (5) dodatnih upravljalnih tipkal EM26
- vezava z menjalnimi stikali ni možna
- vgrajene zaščite pred kratkim stikom, pregrevanjem in preobremenitvijo
- napajanje 230V~ 50Hz
- vgrajena elegantna LED osvetlitev, z možnostjo nastavitve barve in jakosti
- omogoča zamenjavo klasičnega stikala - dvožična vezava<sup>(1)</sup>
- s trožično vezavo dosežemo polno funkcionalnost zatemnilnika<sup>(2)</sup>
- ustreza EN 60669-1 in EN 60669-2-1
- vijajna pritrditev vodnikov 1.5mm<sup>2</sup> (maks. moment pritvija vijakov 0,4 Nm)



TOUCH EM25 je mikroprocesorsko voden elektronski zatemnilnik. Omogoča vklop, izklop in zatemnjevanje vseh zatemnilnih in nekaterih nezatemnilnih žarnic in sijalk. Vgrajeni mikroprocesor samodejno zazna vrsto sijalke in prilagodi režim delovanja. Ob izklopu si zapomni zadnje nastavitve, saj ima vgrajeno spominsko funkcijo. Funkcija mehkega zagona podaljša življenjsko dobo sijalk. V tipko je vgrajena elegantna LED osvetlitev, z možnostjo izbire barve in nastavitve jakosti. Na EM25 lahko vezemo do 5 dodatnih upravljalnih tipkal EM26 (»slave«).

TOUCH EM25 is microprocessor controlled electronic light dimmer. It serves as switch and dimmer for dimmable and some of non-dimmable lamps. Integrated microprocessor automatically identifies the type of lamp and adjusts the operating mode. It remembers the level of dimming after switching off due to integrated memory function. Soft-start function extends the lamp service life. In button integrated elegant LED illumination enables many different colors and intensity levels. Optionally one can connect up to 5 additional control tasters EM26 (»slave«).

SWITCH / DIMMER UNIVERSAL RLC 0-300W 2M

- universal electronic dimmer for ON/OFF switching and dimming of all dimmable lamps (classical, halogen, LED, CFL, ...) and some non-dimmable lamps
- automatic detection of lamp type and adjustment of operating mode
- reduction of energy consumption
- soft start function extends life of lamps
- controlled by build-in micro switches
- memory function included - memorizes brightness on turn-off
- up to five (5) additional control units EM26 can be connected
- connection with 2-way switch is not possible
- build-in short-circuit, overheating and overload protection
- supply voltage 230V~ 50Hz
- elegant LED illumination, adjustable colour and brightness
- replacement of classical switch is possible at two-wire connection<sup>(1)</sup>
- full functionality is achieved at three-wire connection<sup>(2)</sup>
- in accordance with EN 60669-1 and EN 60669-2-1
- screw contacts 1.5mm<sup>2</sup> (max. tightening torque 0.4Nm)

<sup>(1)</sup>dvožična vezava  
two-wire connection

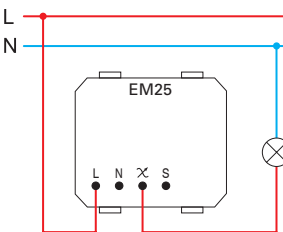

- dvožična vezava omogoča zatemnjevanje zatemnilnih žarnic in sijalk

- two-wire connection allows dimming of dimmable lamps

<sup>(2)</sup>trožična vezava  
three-wire connection

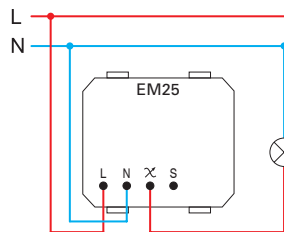

- trožična vezava omogoča zatemnjevanje zatemnilnih žarnic in sijalk in nekaterih nezatemnilnih LED in CFL sijalk

- three-wire connection allows dimming of dimmable lamps and some of non-dimmable LED and CFL lamps

	1	2	5	6	7
Min.	40 W	40 W	40 VA	40 VA	40 VA
Max.	300 W	300 W	300 VA	100 VA	100 VA
	(F)	(F)	(F)		

1 - žarnica z žarilno nitko / incandescent lamp

2 - halogenska žarnica / halogen lamp

4 - zatemnilni elektronski transformator / dimmable electronic transformer

5 - klasični transformator / classical transformer

	1	2	4	6	7	8	9
Min.	0 W	0 W	0 VA	0 VA	0 VA	0 VA	0 VA
Max.	300 W	300 W	120 VA	120 VA	120 VA	120 VA	120 VA
	(F)	(F)	(F)			(F)	(F)

6 - zatemnilna varčna CFL sijalka / dimmable energy saving CFL lamp

7 - zatemnilna LED sijalka / dimmable LED lamp

8 - nezatemnilna varčna CFL sijalka / non-dimmable energy saving CFL lamp

9 - nezatemnilna LED sijalka / non-dimmable LED lamp

opombe / remarks

- (F) filter EM27

- priporočamo uporabo filtra EM27 / it is recommended to use filter EM27

- vse krmiljene žarnice in sijalke morajo biti enake / all controlled lamps must be the same

- tabela bremen velja za sijalke s faktorjem PF>0.5 / table of loads is valid for lamps with power factor PF>0.5



vklop in izklop ter zatemnjevanje luči /  
on / off switching and dimming of lamp

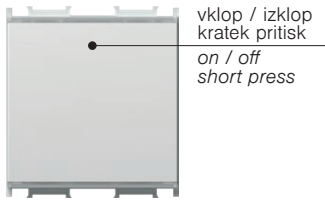

vklop / izklop  
kratek pritisk  
on / off  
short press

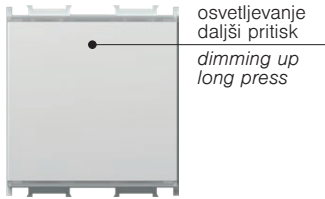

osvetljevanje  
daljši pritisk  
dimming up  
long press

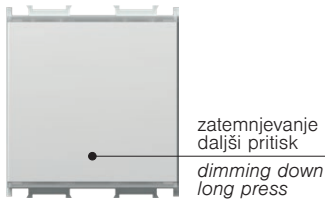

zatemnjevanje  
daljši pritisk  
dimming down  
long press

izbira barve in nastavev jakosti LED osvetlitve /  
LED colour selection and intensity level adjustment

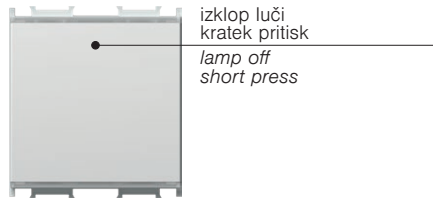

izklop luči  
kratek pritisk  
lamp off  
short press

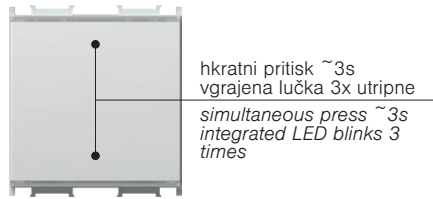

hkratni pritisk ~3s  
vgrajena lučka 3x utripne  
simultaneous press ~3s  
integrated LED blinks 3  
times

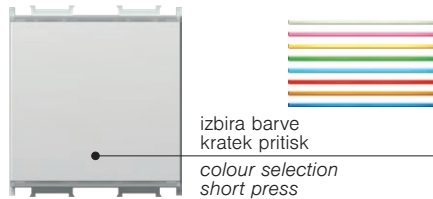

izbira barve  
kratek pritisk  
colour selection  
short press

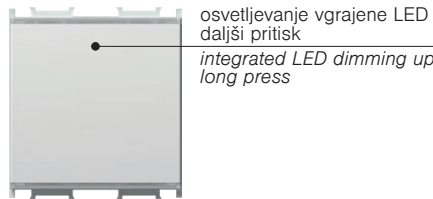

osvetljevanje vgrajene LED  
daljši pritisk  
integrated LED dimming up  
long press

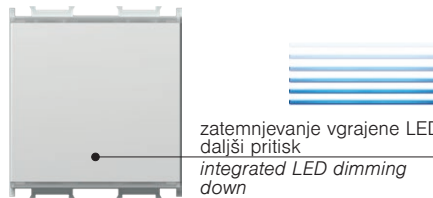

zatemnjevanje vgrajene LED  
daljši pritisk  
integrated LED dimming  
down  
long press



shranitev nastavev - hkratni kratek  
pritisk  
vgrajena lučka 3x utripne  
settings saving - simultaneous short  
press  
integrated LED blinks 3 times

\*funkcija "RESET" /  
"RESET" function

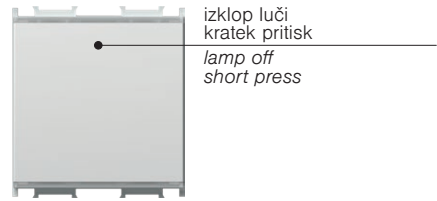

izklop luči  
kratek pritisk  
lamp off  
short press

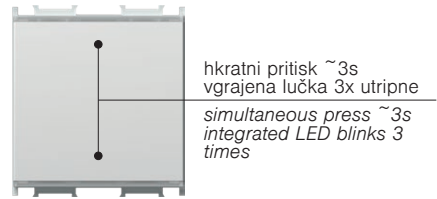

hkratni pritisk ~3s  
vgrajena lučka 3x utripne  
simultaneous press ~3s  
integrated LED blinks 3  
times

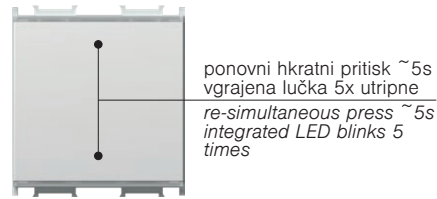

ponovni hkratni pritisk ~5s  
vgrajena lučka 5x utripne  
re-simultaneous press ~5s  
integrated LED blinks 5  
times

- \* - priporočamo ob vgraditvi zatemnilnika in menjavi žarnic ali sijalk
- obvezno ob uporabi nezatemnilnih sijalk
- funkcija "RESET" pri uporabi dvožične vezave ne deluje
- možno samo pri EM25
- it is recommended at dimmer installation and lamp replacement
- mandatory when using non-dimmable lamps
- "RESET" function is not possible when using two-wire connection
- only possible on EM25

opozorila za vgradnjo /  
installation precautions

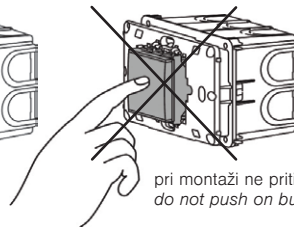
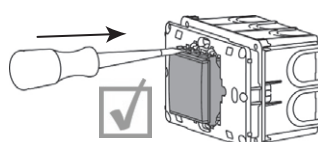
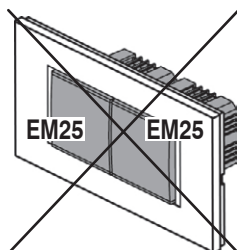
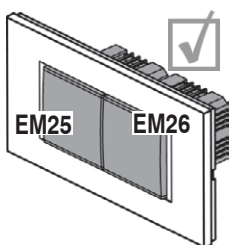

pri montaži ne pritiskaj na tipko /  
do not push on button during mounting

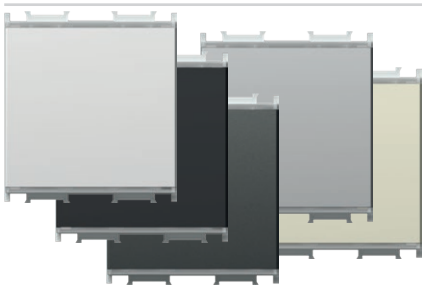

- EM26PW
- EM26SB
- EM26AT
- EM26ES
- EM26IW

**TIPKALO UPRAVLJALNO 2M**

- v povezavi z univerzalnim zatemnilnikom EM25 omogoča upravljanje luči z več (do pet) lokacij z enako funkcionalnostjo kot EM25
- napajanje 230V<sup>~</sup> 50Hz
- ustreza EN 60669-1 in EN 60669-2-1
- vijačna pritrditev vodnikov 1.5mm<sup>2</sup> (maks. moment privitja vijakov 0,4 Nm)

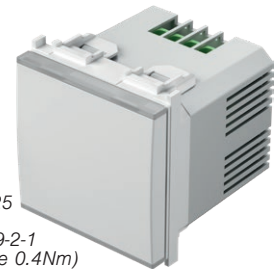

**PUSH-BUTTON CONTROL UNIT 2M**

- connected to universal dimmer EM25 allows controlling of lamps with same functionality as EM25
- supply voltage 230V<sup>~</sup> 50Hz
- in accordance with EN 60669-1 and EN 60669-2-1
- screw contacts 1.5mm<sup>2</sup> (max. tightening torque 0.4Nm)

(1) dvožična vezava  
two-wire connection

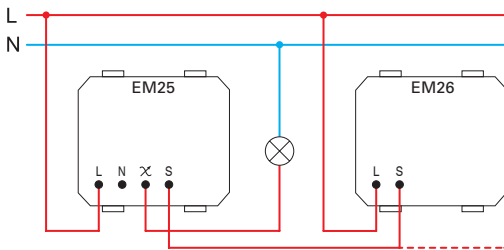

- dvožična vezava omogoča zatemnjevanje zatemnilnih žarnic in sijalk
- pri dvožični vezavi uporaba vsakega dodatnega upravljalnega tipkala poveča minimalno moč bremena za 25W

- two-wire connection allows dimming of dimmable lamps
- in a two-wire connection each additional control unit increases the minimum load by 25W

(2) trožična vezava  
three-wire connection

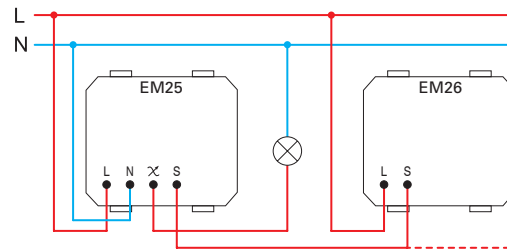

- trožična vezava omogoča zatemnjevanje zatemnilnih žarnic in sijalk in nekaterih nezatemnilnih LED in CFL sijalk

- three-wire connection allows dimming of dimmable lamps and some of non-dimmable LED and CFL lamps

**FILTER OMREŽNIH MOTENJ**

EM27

- filter frekvenčnih motenj za EM25
- slika je simbolična

**FREQUENCY FILTER**

- frequency filter for EM25
- image is symbolic

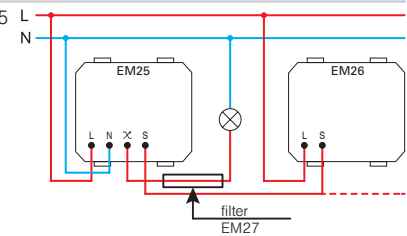

**SET STIKALO / ZATEMNILNIK UNIVERZALNI RLC 0-300W 2M PP OL20**

EM25PPOL20

- set vsebuje zatemnilnik EM25, nosilec 2M in okvir LINE 2M PW
- za tehnični opis glej EM25

**SET SWITCH / DIMMER UNIVERSAL RLC 0-300W 2M PP OL20**

- set includes dimmer EM25, mounting frame 2M and cover plate LINE 2M PW
- for technical details see EM25

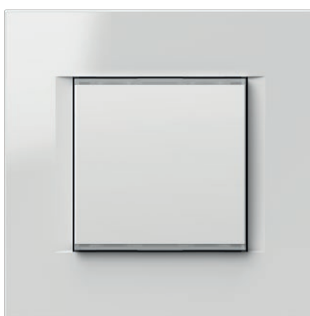

2M = 45 x 45

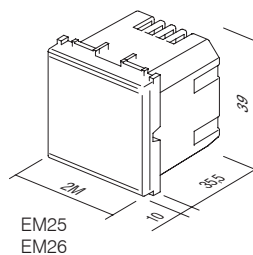

EM25  
EM26



- EM31PW
- EM31SB
- EM31AT
- EM31ES
- EM31IW

**IR STIKALO 5A 230V~ 1M**

- IR infrardeče stikalo
- napajanje: 230V~ ±10 % 50Hz
- rele: 5A / 250V~ izhod za omejen tok z visokim uporom za zero crossing
- stopnja varnosti: IP40
- presek žic pri stičniku: 0,75 - 2,5 mm<sup>2</sup>
- kot zaznavanja: do 110° pri 20°C
- območje zaznavanja: približno 8 m pri 20°C
- nastavljivost časovnega trajanja: od približno 5 s do 12 min
- nastavljivost osvetlitve: od približno 5 do 200 LUX
- temperatura delovanja: od 0°C do +40°C
- ni primeren za vgradnjo v doze, globine 45 mm in ohišja CUBO IP20
- samo za notranjo uporabo



**IR SWITCH 5A 230V~ 1M**

- IR infrared switch
- supply voltage: 230V~ ±10 % 50Hz
- relay: 5A / 250V~ output for limited current with high resistance for zero crossing
- protection rating: IP40
- cross-section of wires at the contact terminal: 0.75 - 2.5 mm<sup>2</sup>
- detection angle: up to 110° at 20°C
- detection area: approx. 8 m at 20°C
- adjustability of duration: from approx. 5 s to 12 min
- adjustability of brightness: from approx. 5 to 200 LUX
- operating temperature: from 0°C to +40°C
- not suitable for installation in 45 mm deep boxes and surface mount box CUBO IP20
- only for indoor usage



- EM32PW
- EM32SB
- EM32AT
- EM32ES
- EM32IW

**IR STIKALO 5A 230V~ 2M**

- IR infrardeče stikalo
- napajanje: 230V~ ±10 % 50Hz
- rele: 5A / 250V~ izhod za omejen tok z visokim uporom za zero crossing
- stopnja varnosti: IP40
- presek žic pri stičniku: 0,75 - 2,5 mm<sup>2</sup>
- kot zaznavanja: do 110° pri 20°C
- območje zaznavanja: približno 8 m pri 20°C
- nastavljivost časovnega trajanja: od približno 5 s do 12 min
- nastavljivost osvetlitve: od približno 5 do 200 LUX
- temperatura delovanja: od 0°C do +40°C
- ni primeren za vgradnjo v doze, globine 45 mm in ohišja CUBO IP20
- samo za notranjo uporabo



**IR SWITCH 5A 230V~ 2M**

- IR infrared switch
- supply voltage: 230V~ ±10 % 50Hz
- relay: 5A / 250V~ output for limited current with high resistance for zero crossing
- protection rating: IP40
- cross-section of wires at the contact terminal: 0.75 - 2.5 mm<sup>2</sup>
- detection angle: up to 110° at 20°C
- detection area: approx. 8 m at 20°C
- adjustability of duration: from approx. 5 s to 12 min
- adjustability of brightness: from approx. 5 to 200 LUX
- operating temperature: from 0°C to +40°C
- not suitable for installation in 45 mm deep boxes and surface mount box CUBO IP20
- only for indoor usage

območje zaznavanja /  
detection range

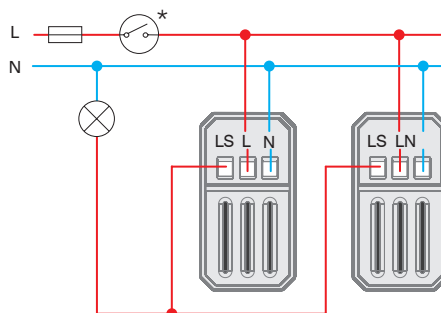
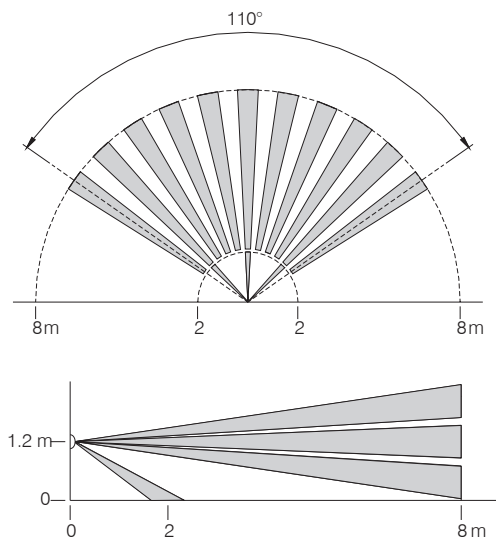

nastavitev občutljivosti in časa osvetlitve /  
time and twilight adjustment

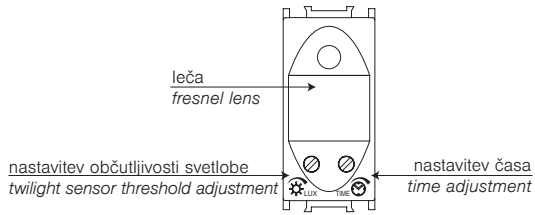

	~5 s	~12 min

	1	2	3	4	5	6	7	8
Min.	1 W	1 W		1 VA	1 W	1 W	1 VA	1 VA
Max.	800 W	800 W	5A	6x20 VA	6x36 W	4x36 W (20µF)	6x23 VA	6x20 VA

1 - žarnica z žarilno nitko /  
incandescent lamp

2 - halogenska žarnica /  
halogen lamp

3 - uporovno grelno telo /  
resistive heating element

4 - elektronski transformator /  
electronic transformer

5 - fluorescentna cev (izvedba 1) /  
fluorescent tube (version 1)

6 - fluorescentna cev (izvedba 2) /  
fluorescent tube (version 2)

7 - varčna CFL sijalka /  
energy saving CFL lamp

8 - LED sijalka /  
LED lamp

opozorila /  
attention

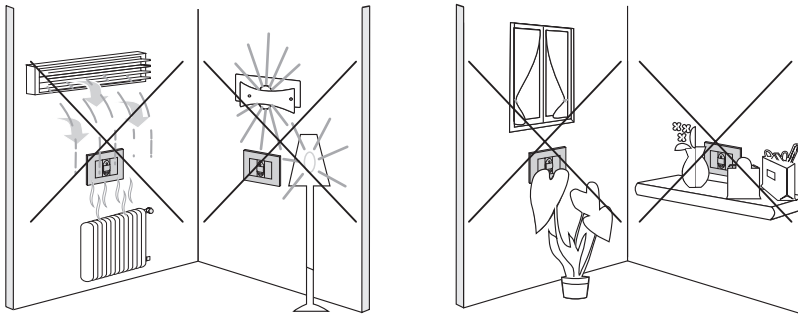

1M = 22,5 x 45

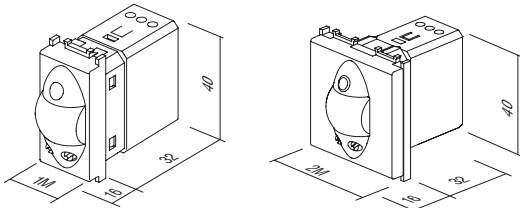



TERMOSTAT OSNOVNI 6A 230V~ 2M



- EM37PW
- EM37SB
- EM37AT
- EM37ES
- EM37IW



Termostat je namenjen reguliranju temperature v prostoru. Termostat omogoča dva načina delovanja – ogrevanje ali hlajenje. Vgrajene ima varovalne funkcije zaščito proti zmrzovanju (način ogrevanja) in zaščito proti pregrevanju (način hlajenja). Delovanje se signalizira s pomočjo LED lučk. Nastavljanje termostata se vrši s pomočjo rotacijskega gumba za nastavev temperature in kapacitivnih tipk na dotik.

The thermostat is intended for regulating temperature in a room. A thermostat enables two modes of operation – heating or cooling. It has safety functions installed for protection against freezing (heating mode) and protection against overheating (cooling mode). The operation is indicated via LED lights. Thermostat setup is performed with the help of a rotary button for setting the temperature and with other capacitive touch buttons.

- termostat elektronski osnovni
- način delovanja: ogrevanje / hlajenje / izklop
- napajanje: 230 VAC, 50 Hz
- izhod: 6(2) A, 230 VAC, preklopni rele
- območje regulacije: +10 °C do +30 °C
- histereza: ±0,5 °C, ED = 20min
- zaščita proti zmrzovanju (način ogrevanje): +6 °C
- zaščita proti pregrevanju (način hlajenje): +32 °C
- funkcija ECO za znižanje temperature za 3 °C za 6 ur v načinu ogrevanje in povečanje temperature za 3 °C za 6 ur v načinu hlajenje
- funkcija adaptivni ECO, avtomatsko vsak dan ob istem času zniža temperaturo za 3 °C za 6 ur v načinu ogrevanje in poveča temperaturo za 3 °C za 6 ur v načinu hlajenje
- možnost vklopa ECO režima delovanja z zunanjim proženjem preko ločenega vhoda
- LED indikacija delovanja
- ni primeren za električno talno ogrevanje
- vijačna pritrditev vodnikov max. 2,5 mm<sup>2</sup>
- ustreza LV Direktivi, EMC direktivi, standardi EN60730-1 in EN60730-2-9
- za pravilno delovanje, priporočamo vgradnjo v samostojno dozo, ločeno od naprav, ki generirajo toploto
- temperatura uporabe: 5 ÷ 35 °C
- temperatura skladiščenja: -20 ÷ 50 °C

THERMOSTAT BASIC 6A 230 V ~ 2M

- electronic thermostat, basic
- operation mode: heating/cooling/turn off
- power supply: 230 VAC, 50 Hz
- output: 6(2) A, 230 VAC, relay switch
- regulation range: +10 °C to +30 °C
- hysteresis: ±0.5 °C, ED = 20min
- anti-freeze protection (heating mode): +6 °C
- overheating protection (cooling mode): +32 °C
- ECO function for lowering the temperature by 3 °C for 6 hours in the heating mode and raising temperature by 3 °C for 6 hours in the cooling mode
- adaptive ECO function, automatically every day at the same time lowers the temperature by 3 °C for 6 hours in the heating mode and raises temperature by 3 °C for 6 hours in the cooling mode
- option to turn on the ECO operating mode by external trigger via a separate input
- LED indication of operation
- not suitable for electrical floor heating
- screw contacts max. 2.5 mm<sup>2</sup>
- in accordance with the LV Directive, the EMC Directive, standards EN60730-1 and EN60730-2-9
- for correct operation, we recommend installing in an independent single box, separate from devices that generate heat
- operating temperature: 5 ÷ 35 °C
- storage temperature: -20 ÷ 50 °C

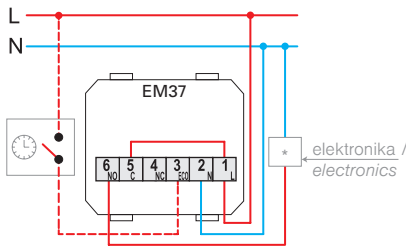

obtočna črpalka, gorilnik (direktna priključitev), termoelektrični pogon / circulation pump, burner (direct connection) thermoelectric drive

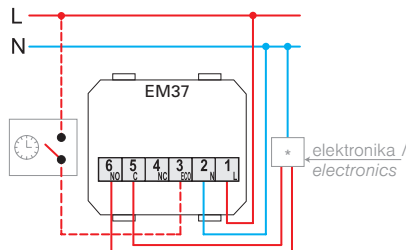

kotel, toplotna črpalka, gorilnik (krmilni vhod T1/T2) / boiler, heat pump, burner (control input T1/T2)

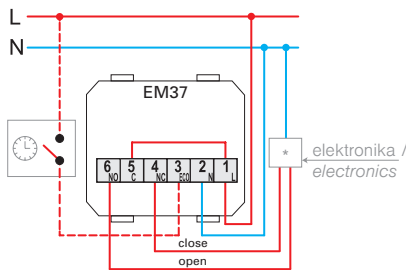

motorni pogon (omejena uporaba pri talnem ogrevanju) / motor drive (limited use with underfloor heating)

nastavev delovanja in temperature / function and temperature adjustment

tipka za izbiro delovanja in LED indikator stanja:  
rdeča: ogrevanje  
modra: hlajenje  
ne sveti: izklopljeno

function selection button and LED status indicator:  
red: heating  
blue: air conditioning  
no light: switched off

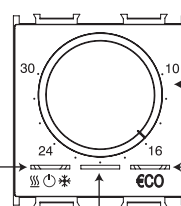

nastavev temperature / temperature setting

tipka za izbiro "ECO" režima in LED indikator "ECO" režima  
zelena: ECO režim vklopljen  
oranžna: adaptivni ECO aktiviran  
ne sveti: dnevni režim

"ECO" function selection button and LED "ECO" status indicator  
green: ECO energy saving ON  
orange: adaptive ECO mode activated  
no light: day mode

LED indikator stanja izhodnega releja  
bela: rele vklopljen  
ne sveti: rele izklopljen

LED output relay state indicator  
white: relay ON  
no light: relay OFF

opozorila / attention

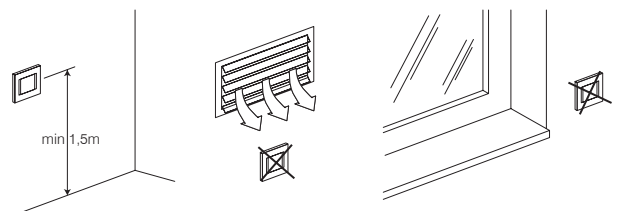

2M = 45 x 45

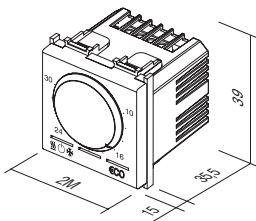

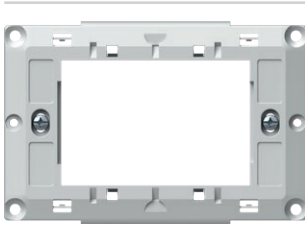

NM39

**NOSILEC Z VIJAKI ZA TERMOSTATE FANTINI COSMI 3M**

- nosilec z vijaki za termostate Fantini Cosmi 3M
- namenjen za uporabo z dnevnimi termostati Fantini Cosmi za modela CH121 in CH123
- namenjen za uporabo s tedenskimi termostati Fantini Cosmi za modela CH141A in CH143A
- montaža v pravokotne doze velikosti 3M
- primeren za sestavo z okvirji PURE, Line, Soft



**MOUNTING FRAME WITH SCREWS FOR FANTINI COSMI THERMOSTATS 3M**

- mounting frame with screws for Fantini Cosmi thermostats 3M
- suitable for use with Fantini Cosmi daily thermostats models CH121 and CH123
- suitable for use with Fantini Cosmi weekly thermostats models CH141A and CH143A
- for mounting in rectangular boxes 3M
- suitable for assembling with cover plates PURE, Line, Soft



- EM40PW
- EM40SB
- EM40AT
- EM40ES
- EM40IW

**KARTIČNO STIKALO ZA VARČEVANJE Z ENERGIJO 3A 250V~ 3M**

- kartično stikalo osnovno, poljubna ISO kartica
- napajanje 230V~ 50Hz
- izhod 3A 250V~ za vklop zunanjega kontaktorja \*
- zakasnitev izklopa 15-20s
- ustreza EN 61000-6-1
- kartica ni priložena
- ni namenjeno kontroli pristopa



**ENERGY SAVER CARD SWITCH 3A 250V~ 3M**

- card switch basic, any ISO card
- supply voltage 230V~ 50Hz
- output 3A 250V~ for switching contactor \*
- switch off delay 15-20s
- in accordance with EN 61000-6-1
- card is not included
- not for access control

3M = 67,5 x 45

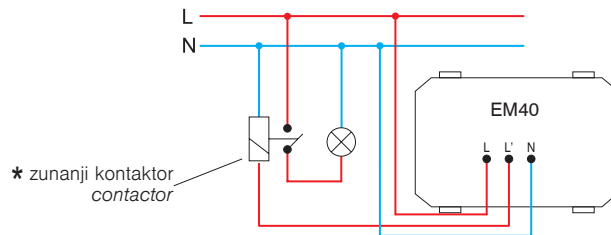
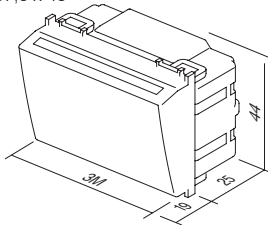

\* zunanji kontaktor  
contactor

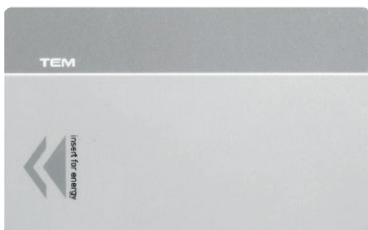

EM47

**KARTICA ISO**

- ISO kartica
- za uporabo s kartičnim stikalom EM40
- velikost: 85x54 mm

**CARD ISO**

- ISO card
- for combination with card switch EM40
- size: 85x54 mm



EM44BK

**KARTIČNO STIKALO ZA VARČEVANJE Z ENERGIJO RF HF 13,56MHz 3M**

- kartično stikalo elektronsko na RFID ISO kartico
- napajanje iz rele enote EM49 preko kabla s konektorji RJ12
- izhod za povezavo z rele enoto EM49
- zakasnitev izklopa "main power" ob izvlečenju kartice 15-20 s
- zakasnitev izklopa "HVAC" ob izvlečenju kartice pri odprtih balkonskih vratih ali oknu - 1 min
- ustreza EN 61000-6-1
- kartica ni priložena
- ni namenjeno kontroli pristopa

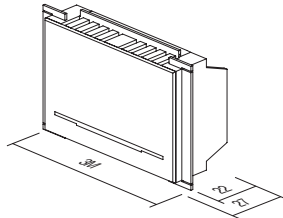

**ENERGY SAVER CARD SWITCH RF HF 13,56MHz 3M**

- electronic card switch for RFID ISO card
- supply from relay unit EM49 through cable connectors RJ12
- output to be connected to relay output unit EM49
- 15-20s "main power" switch off delay with card withdrawal
- 1 min "HVAC" switch off delay with card withdrawal when balcony doors or windows opened
- in accordance with EN 61000-6-1
- card is not included
- not for access control

**RELE ENOTA ZA KARTIČNO STIKALO 2X16A 250V~**

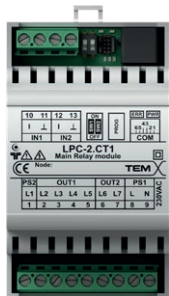

EM49

- rele enota za kartična stikala EM44
- napajanje 230V~ 50 Hz
- ustreza EN 61000-6-1
- montaža na DIN letev 35mm, 3MU
- vhodi in izhodi glede na vgradnjo: enosobno ali dvosobno

**ENERGY SAVER CONTROL UNIT 2x16A 250V~**

- relay unit for card switches EM44
- supply voltage 230V~ 50Hz
- in accordance with EN 61000-6-1
- mounting on DIN rail 35mm, 3MU
- input and output depending on implementation: single or double room

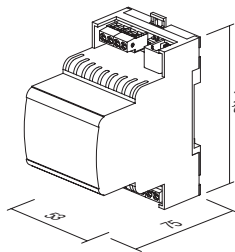

**RAZDELILNIK SPL-1**



EM45

- za povezavo dveh kartičnih stikal EM44 z rele enoto EM49
- komunikacijski konektor RJ12
- velikost: 37 x 30 x 27 mm

**SPLITTER SPL-1**

- used to connect two peripheral modules EM44 to relay unit EM49
- communication connector RJ12
- size: 37 x 30 x 27 mm

vezalna shema za enosobno delovanje / wiring diagram for single room implementation

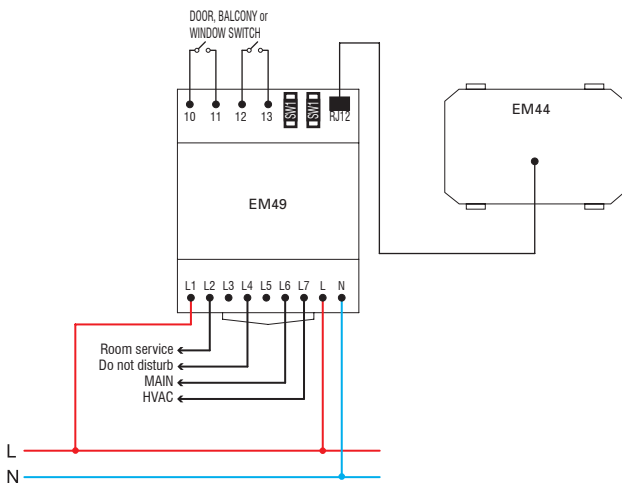

vezalna shema za dvosobno delovanje / wiring diagram for double room implementation

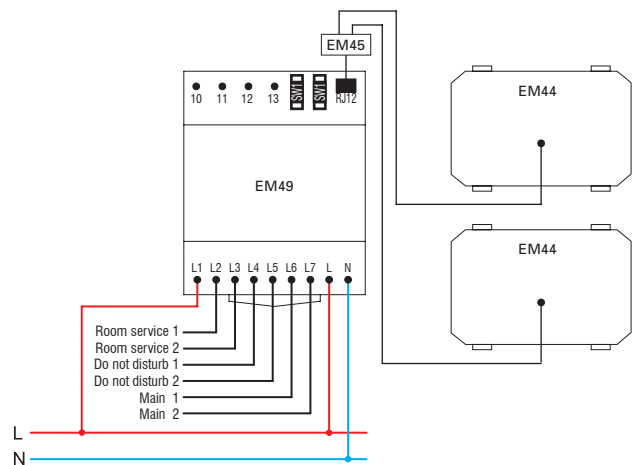

povezovalni kabel RJ12 med EM44 in EM49 / connection cable RJ12 between EM44 and EM49

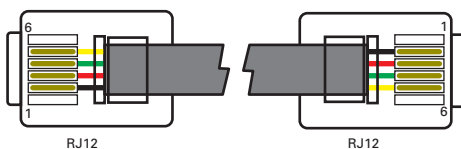

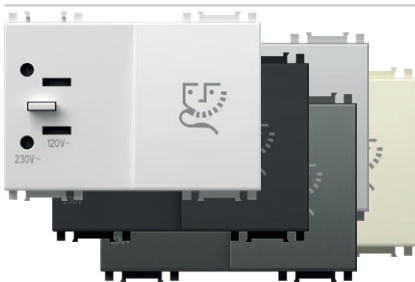

- EM60PW
- EM60SB
- EM60AT
- EM60ES
- EM60IW

**VTIČNICA ZA BRIVNIK 230V~/120V~ 3M**

- vtičnica za brivnik z ločilnim transformatorjem 20VA
- vhod: 230V~ 50-60Hz
- izhod:
- 230V~ za 2P 2.5A EURO vtič ali
- 120V~ za 2P 15A ameriški vtič
- razred zaščite II
- ustreza EN 61558-2-5



**SOCKET SHAVER 230V~/120V~ 3M**

- shaver supply unit with isolating transformer 20VA
- supply: 230V~ 50-60Hz
- output:
- 230V~ for 2P 2.5A Europlug or
- 120V~ for 2P 15A American plug
- Class II
- in accordance with EN 61558-2-5

3M = 67,5 x 45

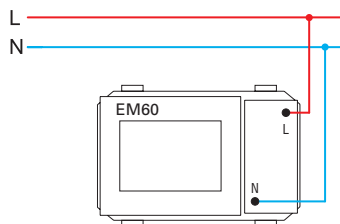
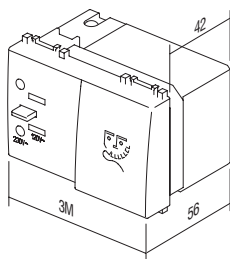

- EM66PW
- EM66SB
- EM66AT
- EM66ES
- EM66IW

**POLNILNIK USB 5V 2,1A 1M**

- za polnjenje elektronskih naprav prek standardnega USB priključka (kompatibilno tudi z Apple napravami)
- napajanje: 100-230 V~ 50/60 Hz
- poraba med delovanjem: 300 mA pri 100 V~/150 mA pri 230 V~
- poraba v mirovanju: 30 mW pri 230 V~
- izhodna napetost: 5 VDC (±5 %) SELV
- nihanje izhodne napetosti: 150 mV
- nominalni izhodni tok: 2,1 A (1 x 2.100 mA) (±10 %)
- učinkovitost: maksimalno 77 %
- temperatura delovanja: 0 °C/+ 45 °C (notranja uporaba)
- IP zaščitni razred: IP20, samo za notranjo uporabo
- varnostni razred naprepe II
- prenapetostna zaščita (EN 62109): razred III
- vijacna pritrditev vodnikov max. 2.5 mm<sup>2</sup>
- naprava z odklikom kontaktov min. 3 mm
- ustreza standardu EN 60950-1 in direktivam EMC in LVD

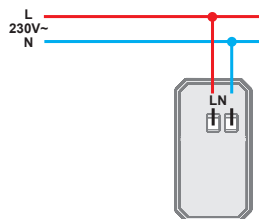
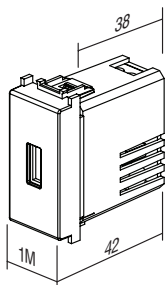

**USB POWER SUPPLY UNIT 5V 2,1A 1M**

- for charging of electronic devices via a standard USB port (also compatible with Apple devices)
- power supply: 100-230V~ 50/60Hz
- power consumption: 300mA at 100V~/150mA at 230V~
- standby power consumption: 30mW at 230V~
- nominal output voltage: 5 VCD (± 5%) SELV
- output ripple voltage: 150mV
- nominal output current: 2,1A (1 x 2.100mA) (±10%)
- efficiency: maximum of 77%
- operating temperature: 0°C/+45°C (indoor use)
- IP protection class: IP20, indoor use only
- class device II
- overvoltage category (EN 62109): Class III
- screw contacts: max. 2.5 mm<sup>2</sup>
- device with a contact gap of at least 3mm
- in accordance with EN 60950-1 and LVD & EMC directives

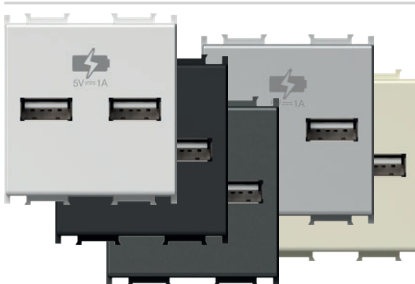

- EM65PW
- EM65SB
- EM65AT
- EM65ES
- EM65IW

**POLNILNIK USB 5V 1A 2M**

- za polnjenje elektronskih naprav preko standardnega USB priključka (kompatibilno tudi z Apple napravami)
- omogoča hkratno polnjenje dveh naprav
- napajanje: 230V~ 50Hz
- poraba v mirovanju: 50 mW pri 230V~
- izhodna napetost: 5 VDC (±5%) SELV
- nihanje izhodne napetosti: 150 mV
- nominalni izhodni tok: 1 A (1 x 1.000 mA ali 2 x 500 mA) (±10%)
- učinkovitost: več kot 67%
- IP zaščitni razred: IP20, samo za notranjo uporabo
- vijacna pritrditev vodnikov max. 2.5 mm<sup>2</sup>
- ustreza standardom EN 60950-1 in EMC direktivi
- polnilnik mora biti varovan z ustreznim zunanjim odklopnikom



2M = 45 x 45

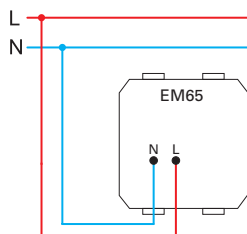
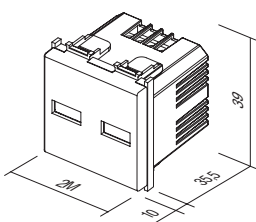

**POWER SUPPLY UNIT USB 5V 1A 2M**

- for charging of electronic devices via a standard USB port (also compatible with Apple devices)
- enables charging of two devices simultaneously
- power supply: 230V~ 50Hz
- stand-by power consumption: 50 mW at 230V~
- nominal output voltage: 5 VDC (±5%) SELV
- output ripple voltage: 150 mV
- nominal output current: 1 A (1 x 1.000 mA or 2 x 500 mA) (±10%)
- efficiency: greater than 67%
- IP protection class: IP20, indoor use only
- screw contacts: max. 2.5 mm<sup>2</sup>
- in accordance with EN 60950-1 and EMC directive
- an appropriate external disconnect device needs to be considered as part of installation





- EM67PW
- EM67SB
- EM67AT
- EM67ES
- EM67IW

**POLNILNIK USB 5V 2,4A 1M**

- za polnjenje elektronskih naprav prek standardnega USB priključka (kompatibilno tudi z Apple napravami)
- napajanje: 100-230 V $\sim$  50/60 Hz
- poraba med delovanjem: 300 mA pri 100 V $\sim$ /150 mA pri 230 V $\sim$
- poraba v mirovanju: 30 mW pri 230 V $\sim$
- izhodna napetost: 5 VDC ( $\pm 5\%$ ) SELV
- nihanje izhodne napetosti: 150 mV
- nominalni izhodni tok: 2,4 A ( $\pm 10\%$ )
- učinkovitost: maksimalno 77%
- temperatura delovanja: 0 °C/+ 45 °C (notranja uporaba)
- IP zaščitni razred: IP20, samo za notranjo uporabo
- varnostni razred naprave II
- prenapetostna zaščita (EN 62109): razred III
- vijakna pritrditev vodnikov max. 2.5 mm $^2$
- naprava z odmikom kontaktov min. 3 mm
- ustreza standardu EN 60950-1 in direktivam EMC in LVD

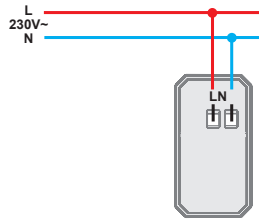
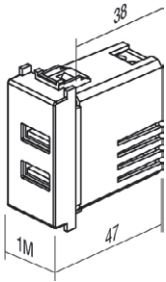

**USB POWER SUPPLY UNIT 5V 2,4A 1M**

- for charging of electronic devices via a standard USB port (also compatible with Apple devices)
- power supply: 100-230V $\sim$  50/60Hz
- power consumption: 300mA at 100V $\sim$ /150mA at 230V $\sim$
- standby power consumption: 30mW at 230V $\sim$
- nominal output voltage: 5 VCD ( $\pm 5\%$ ) SELV
- output ripple voltage: 150mV
- nominal output current: 2,4A ( $\pm 10\%$ )
- efficiency: maximum of 77%
- operating temperature: 0°C/+45°C (indoor use)
- IP protection class: IP20, indoor use only
- class device II
- overvoltage category (EN 62109): Class III
- screw contacts: max. 2.5 mm $^2$
- device with a contact gap of at least 3mm
- in accordance with EN 60950-1 and LVD & EMC directives

**LED ZASILNA SVETILKA 250V~ 0.9W, NiCd 3h 7M**



- EM55

- zasilna LED svetilka
- napajanje 250V $\sim$  50Hz 3xLED 0,3W, 10000mcd, 6500K
- NiCd akumulator 400 mAh, zamenljiv
- avtonomija 3h, polnjenje 24h
- razred zaščite II
- ustreza EN 60598-1, EN 60598-2-2, EN 60598-2-22



**LED EMERGENCY LIGHT 250V~ 0.90W, NiCd 3h 7M**

- emergency LED lamp
- supply voltage 250V $\sim$  50Hz 3x LED 0,3W, 10000mcd, 6500K
- NiCd accumulator 400 mAh, replaceable
- autonomy 3h, charging 24h
- Class II
- in accordance with EN 60598-1, EN 60598-2-2, EN 60598-2-22

7M = 151,5 x 45

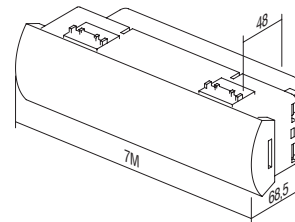
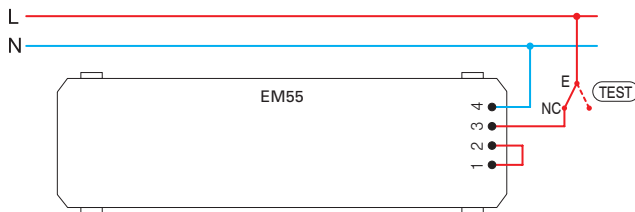

**LED ZASILNA SVETILKA 230V~50Hz, 0.5W, NiMH 2h 2M**



- EM57

- zasilna LED svetilka
- možnost uporabe kot prenosne ročne svetilke (izvlečni mehanizem)
- napajanje 230V 50Hz 1xLED 0.5W
- NiMH akumulator 140mAh, zamenljiv
- avtonomija 2 h, polnjenje 36 h
- varnostni razred naprave II
- ustreza EN60598-1, en60598-2-2, EN62471, EN55015:2006, EN61547

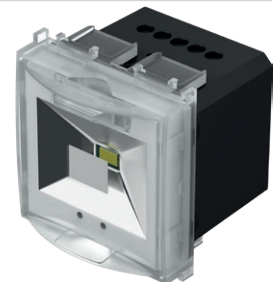

**LED EMERGENCY LIGHT 230V~50Hz, 0.5W, NiMH 2h 2M**

- emergency LED lamp
- option to use it as a hand lamp (pull-out mechanism)
- supply voltage 230V $\sim$  50Hz, 1xLED 0.5W
- NiMH accumulator 140mAh, replaceable
- autonomy 2h, charging 36h
- class device II
- in accordance EN60598-1, EN60598-2-2, EN62471, EN55015:2006, EN61547

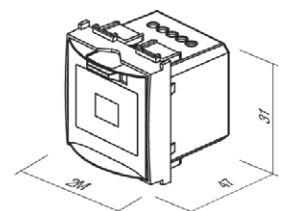
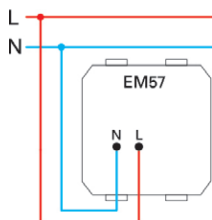

## SVETILKA LED ENOBARVNA 250V~ 0,8W 2M

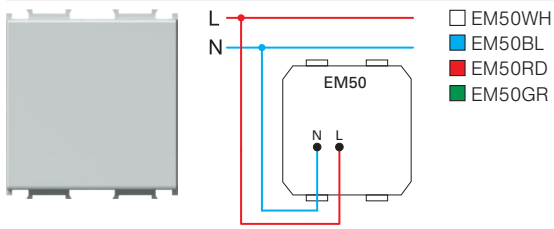

- LED svetilka za osvetlitev stopnišč ali hodnikov
- napajanje 230V~ 50Hz 0,8W, 6500K
- razred zaščite II
- ustreza EN 60598-1
- uporaba tudi za usmerjanje ali signalizacijo z možnostjo laserskega tiska poljubne grafike

## LED LAMP MONOCOLOR 250V~ 0,8W 2M

- step marker LED lamp
- supply voltage 230V~ 50Hz 0,8W, 6500K
- Class II
- in accordance with EN 60598-1
- optional usage for directional or signal illumination with customized laser printing on diffuser



## SVETILKA LED DVOBARVNA 250V~ 2x0,4W 2M

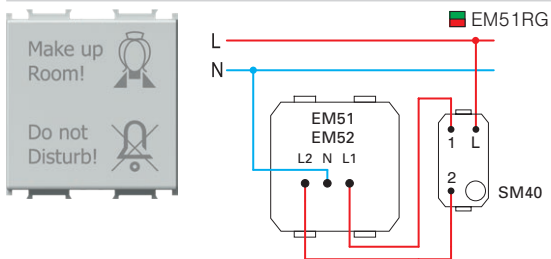

- LED dvoobarvna svetilka (rdeča/zelena) za signalizacijo
- napajanje 230V~ 50Hz 2x0,4W, 6500K
- razred zaščite II
- ustreza EN 60598-1
- vsebuje grafiko kot na sliki
- možnost laserskega tiska poljubne grafike

## LED LAMP DUAL COLOR 250V~ 2x0,4W 2M

- signaling dual color (red/green) LED lamp
- supply voltage 230V~ 50Hz 2x0,4W, 6500K
- Class II
- in accordance with EN 60598-1
- diffuser includes graphics as shown
- possible customized laser printing on diffuser



## SVETILKA LED 3D DVOBARVNA 250V~ 2x0,4W 2M

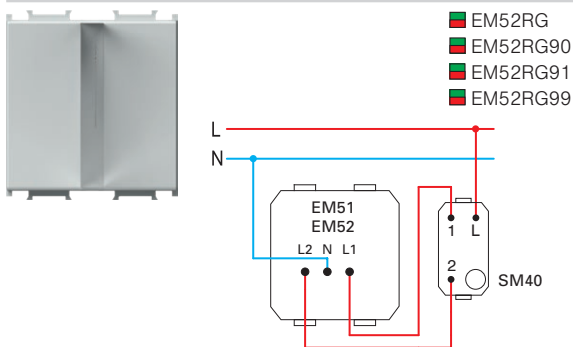

- LED dvoobarvna svetilka (rdeče/zelena) s 3D simbolom, za signalizacijo
- napajanje 230V~ 50Hz 2x0,4 W, 6500K
- razred zaščite II
- ustreza EN 60598-1
- možnost tiska različnih grafik po naročilu
- 90 moški simbol, 91 ženski simbol, 99 simbol po naročilu

## LED LAMP 3D DUAL COLOR 250V~ 2x0,4W 2M

- signalling LED lamp, dual color (red/green) with 3D symbol
- supply voltage 230V~ 50Hz 2x0,4W, 6500K
- class II
- in accordance with EN 60598-1
- possible customized graphics on request
- 90 male symbol, 91 female symbol, 99 symbol on request

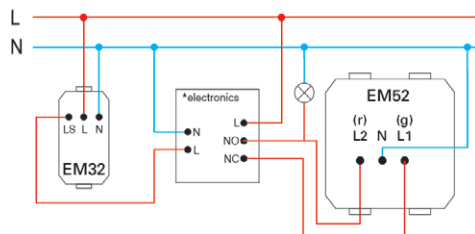
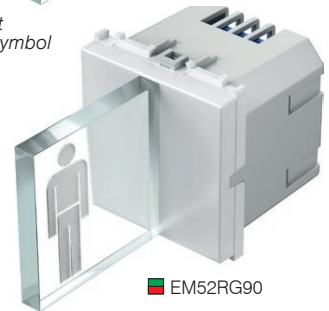

2M = 45 x 45

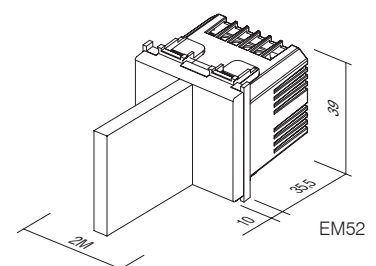
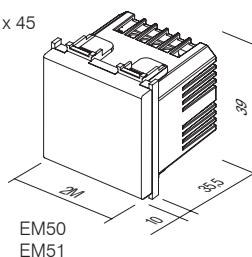

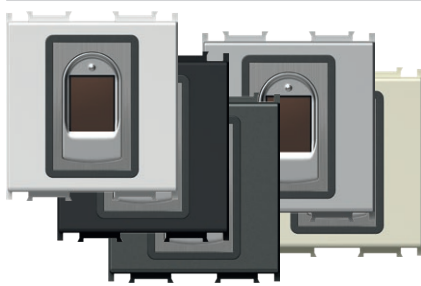

- EM71PW
- EM71SB
- EM71AT
- EM71ES
- EM71IW

**STIKALO NA PRSTNI ODTIS BIOPASS 2M**

- stikalo na prstni odtis v kompletu z notranjo rele enoto in napajalnikom
- kapaciteta: 500 prstnih odtisov
- enostavno upravljanje prek mobilne aplikacije X-Manager
- napajalna napetost: 8-30 V – DC ali AC (napajalnik priložen)
- kapacitivni senzor
- 2 izhodna releja
- maksimalna napetost/tok na releju: 40V/3A
- čas proženja releja: 1 - 10 s
- maksimalna moč: 3,6 W
- Temperaturno območje delovanja: -30 °C do +80 °C
- Maksimalna vlažnost okolice do: 100 % IP65
- Set vključuje tudi nosilec NM24 in dekorativni okvir OS20.

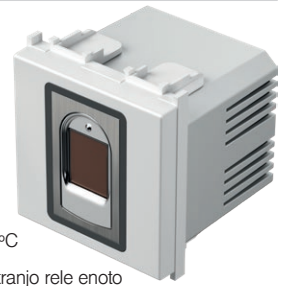

**FINGERPRINT SWITCH BIOPASS 2M**

- fingerprint switch with included internal relay unit and power supply
- capacity: 500 fingerprints
- easy management via X-Manager mobile app
- power supply voltage: 8-30V – DC or AC (power supply included)
- capacitive sensor
- 2 output relays
- maximum voltage/current on relay: 40V/3A
- relay triggering time: 1-10 sec
- maximum power: 3.6W
- 256-bit encrypted link between switch and internal relay unit
- Set also includes NM24 mounting frame and OS20 decorative cover plate.

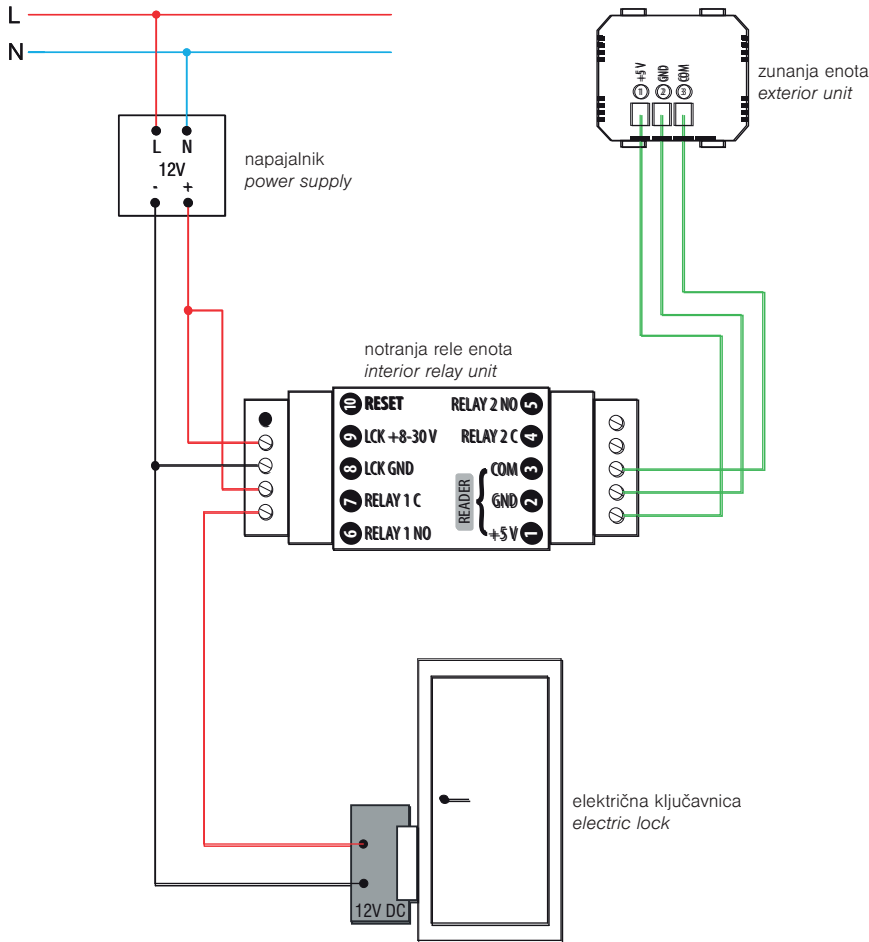

X-Manager app



podpora.tem.si



zunanja enota exterior unit

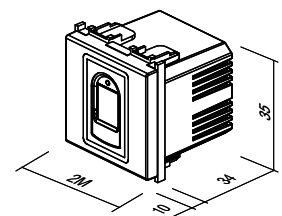

**STIKALO BREZDOTIČNO 10A 240V~**



■ EM80GW

- stikalo brezdotično za vklop in izklop ("master")
- napajanje: 240 V~ 50 Hz
- izhodni rele 10A / 250V~ (2400W pri 240V~)
- nastavljen domet od 2 do 10 cm
- namenjeno za montažo v standardne okrogle doze Ø60 mm
- za priklop je nujen ničelni vodnik (N)
- vezava z menjalnimi stikali ni možna
- možna vezava do 5 upravljalnih stikal EM81
- enostavna montaža dekorativnih okvirjev s pomočjo magnetov
- vijačna pritrditev vodnikov do 2,5 mm<sup>2</sup> (maks. moment privitja vijakov 0,4 Nm)
- ustreza EN 60669-1 in EN 60669-2-1
- samo za notranjo uporabo



*SWITCH, TOUCHLESS 10A 240V~*

- touchless switch for turning on/off ("master")
- power supply: 240 V~ 50 Hz
- output relay 10A / 250V~ (2400W at 240V~)
- adjustable range from 2 to 10 cm
- intended for installation into a standard round Ø60 mm box
- a neutral lead (N) is required for connection
- connection with toggle switches is not possible
- connection with up to 5 EM81 control switches is possible
- simple installation of decorative covers with the help of magnets
- screw fastening of leads up to 2.5 mm<sup>2</sup> (max. screw tightening torque is 0.4 Nm)
- in accordance with EN 60669-1 and EN 60669-2-1
- only for indoor use

**STIKALO BREZDOTIČNO UPRAVLJALNO**



■ EM81GW

- stikalo upravljalno («slave»)
- deluje samo v povezavi s stikalom EM80 ("master")
- nastavljen domet od 2 do 10 cm
- enostavna montaža dekorativnih okvirjev s pomočjo magnetov
- vijačna pritrditev vodnikov do 2,5 mm<sup>2</sup> (maks. moment privitja vijakov 0,4 Nm)
- ustreza EN 60669-1 in EN 60669-2-1
- samo za notranjo uporabo

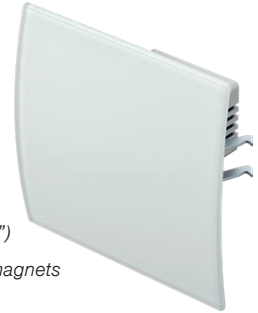

*SWITCH, TOUCHLESS, CONTROL UNIT*

- control switch ("slave")
- works only when connected with the EM80 switch ("master")
- adjustable range from 2 to 10 cm
- simple installation of decorative covers with the help of magnets
- screw fastening of leads up to 2.5 mm<sup>2</sup> (max. screw tightening torque is 0.4 Nm)
- in accordance with EN 60669-1 and EN 60669-2-1
- only for indoor use

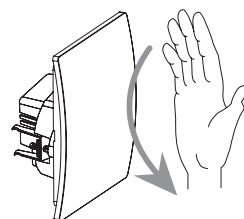
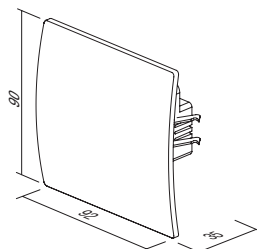
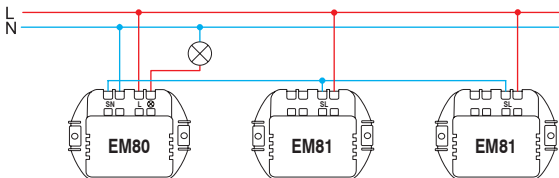
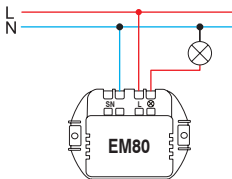



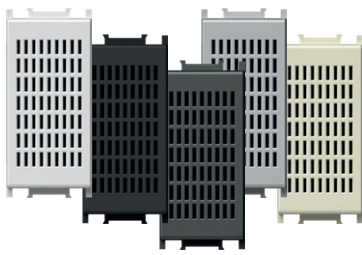

- EM90PW
- EM90SB
- EM90AT
- EM90ES
- EM90IW

**BRENČAČ 8VA 230V~ 1M**

- signalni brenčač
- dolžina zvoka je enaka dolžini pritiska na tipko
- napajanje 230V~ 50Hz 8VA

*BUZZER 8VA 230V~1M*

- signal buzzer
- the sound emission has the same lasting time as the control operation
- supply voltage 230V~ 50Hz 8VA

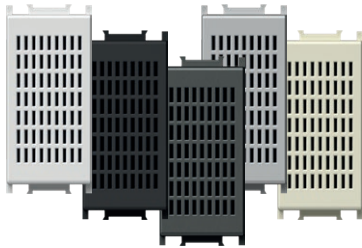

- EM91PW
- EM91SB
- EM91AT
- EM91ES
- EM91IW

**BRENČAČ 8VA 12V~ 1M**

- signalni brenčač
- dolžina zvoka je enaka dolžini pritiska na tipko
- napajanje 12V~ 50Hz 8VA

*BUZZER 8VA 12V~1M*

- signal buzzer
- the sound emission has the same lasting time as the control operation
- supply voltage 12V~ 50Hz 8VA

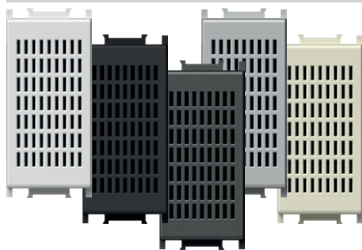

- EM92PW
- EM92SB
- EM92AT
- EM92ES
- EM92IW

**ZVONEC 8VA 230V~ 1M**

- signalni zvonec
- dolžina zvoka je enaka dolžini pritiska na tipko
- napajanje 230V~ 50Hz 8VA

*BELL 8VA 230V~1M*

- signal bell
- the sound emission has the same lasting time as the control operation
- supply voltage 230V~ 50Hz 8VA

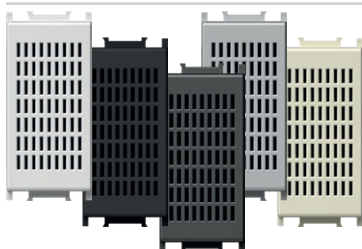

- EM93PW
- EM93SB
- EM93AT
- EM93ES
- EM93IW

**ZVONEC 8VA 12V~ 1M**

- signalni zvonec
- dolžina zvoka je enaka dolžini pritiska na tipko
- napajanje 12V~ 50Hz 8VA

*BELL 8VA 12V~1M*

- signal bell
- the sound emission has the same lasting time as the control operation
- supply voltage 12V~ 50Hz 8VA

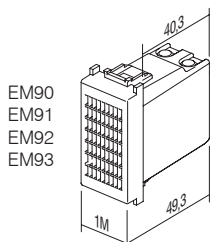

EM90  
EM91  
EM92  
EM93

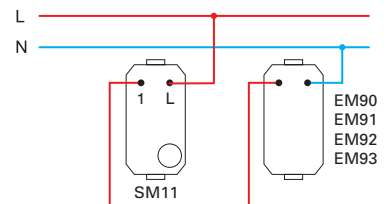

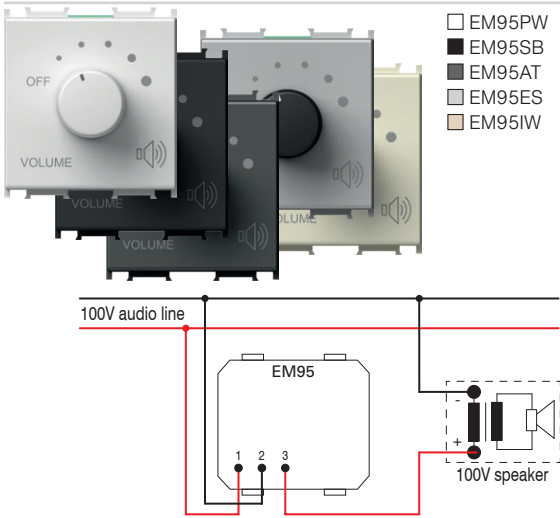

**REGULATOR GLASNOSTI ZA 100V AVDIO LINIJO 35W 2M**

- regulator glasnosti (atenuator) za 100V avdio sisteme
- nazivna moč 35W ( max. 45W), 6 stopenjska nastavev glasnosti
- primeren za vgradnjo v globoke doze (min. 60 mm)
- ni primeren za vgradnjo v doze globine 45 mm in ohišja CUBO IP20
- samo za notranjo uporabo

**VOLUME CONTROL 100V AUDIO LINE 35W 2M**

- volume control (attenuator) for 100V audio systems
- power rating 35W (max.45W), 6 steps volume control
- suitable for boxes min. 60 mm deep
- not suitable for installation in 45 mm deep boxes and surface mount boxes CUBO IP20
- for indoor use only

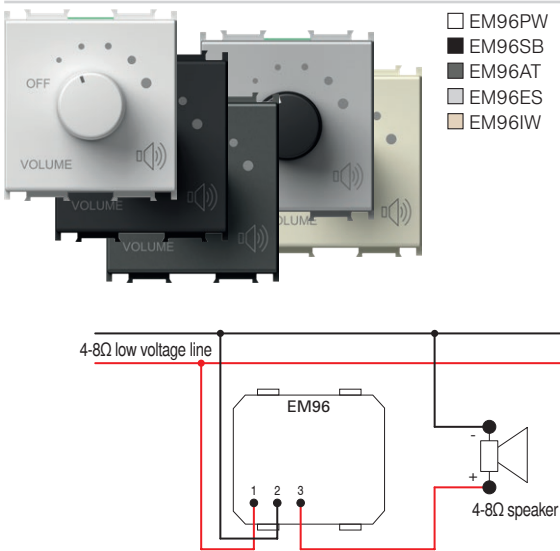
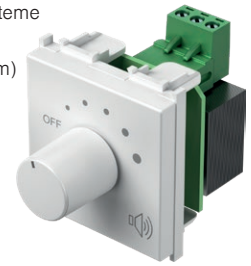

**REGULATOR GLASNOSTI NIZKOOHMSKI 4-8 Ω 35W 2M**

- regulator glasnosti za nizkonapetostne izhode 4-8 Ω 35W
- za priklop na HI-FI naprave
- nazivna moč 35W, 6 stopenjska nastavev glasnosti
- primeren za vgradnjo v globoke doze (min. 60 mm)
- ni primeren za vgradnjo v doze globine 45 mm in ohišja CUBO IP20
- samo za notranjo uporabo

**VOLUME CONTROL 4-8 Ω 35W 2M**

- volume control (attenuator) for low voltage outputs 4-8 Ω, 35W
- power rating 35W, 6 steps volume control
- suitable for boxes min. 60 mm deep
- not suitable for installation in 45 mm deep boxes and surface mount boxes CUBO IP20
- for indoor use only

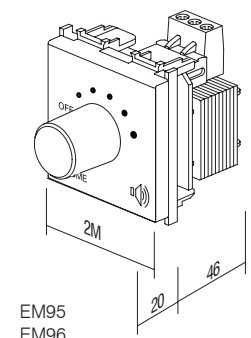

EM95  
EM96



CM25

PW

OS

tip type	naziv description	tehnični opis technical data	velikost size	barva colour	opsijski opis 1 optional data 1
CM10	SET VTIČNIC 2x SCHUKO SOCKET SET 2x SCHUKO	2P+E 16A 250V~ 4M	4M	<input type="checkbox"/> PW bela-sijaj polar white	<input type="checkbox"/> OL okvir LINE cover plate LINE
CM11	SET VTIČNIC 3x SCHUKO SOCKET SET 3x SCHUKO	2P+E 16A 250V~ 7M	7M	<input checked="" type="checkbox"/> SB črna-mat soft touch black	<input type="checkbox"/> OS okvir SOFT cover plate SOFT
CM15	SET VEZNIKOV BARVNI LINK WIRE SET	3x1.5mm <sup>2</sup>	1M	<input checked="" type="checkbox"/> AT antracit anthracite	
⋮	⋮	⋮	⋮	<input type="checkbox"/> ES srebrna-mat elox silver	
⋮	⋮	⋮	⋮	<input type="checkbox"/> IW bež-sijaj ivory white	

SET VTIČNIC 2x SCHUKO 2P+E 16A 250V~ 4M

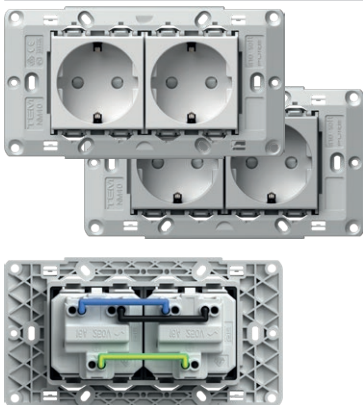

- CM10PW
- CM10ES

- set vtičnic 2x schuko VM10 2P+E 16A 250V~
- vtičnice povezane z vezniki CM16
- z nosilcem 4M brez vijakov
- za pritrnitev nosilcev uporabiti vijake CM17, CM18 ali CM19
- vijačna pritrnitev vodnikov 1.5-2.5 mm<sup>2</sup>
- ustreza IEC 60884-1, CEE7

SOCKETS SET 2x SCHUKO 2P+E 16A 250V~ 4M

- socket set 2x schuko VM10 2P+E 16A 250V~
- prewired with link wires CM16
- with mounting frame 4M without screws
- for mounting frame fixing use screws CM17, CM18 or CM19
- screw contacts 1.5-2.5 mm<sup>2</sup>
- in accordance with IEC-60884-1, CEE7

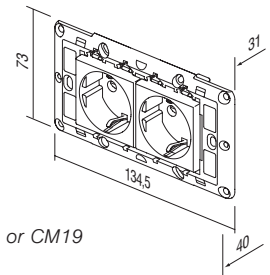

SET VTIČNIC 3x SCHUKO 2P+E 16A 250V~ 7M

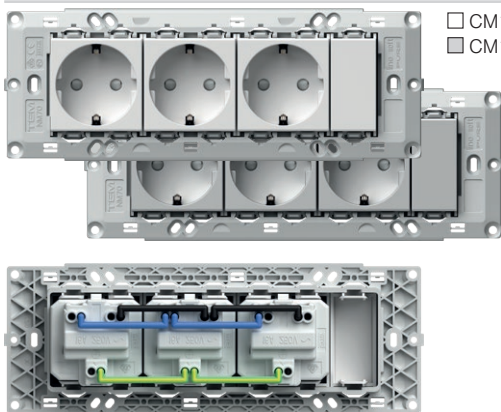





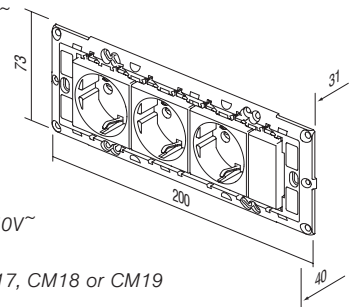

- CM11PW
- CM11ES

- set vtičnic 3x schuko VM10 2P+E 16A 250V~
- vtičnice povezane z vezniki CM16
- z nosilcem 7M brez vijakov
- za pritrnitev nosilcev uporabiti vijake CM17, CM18 ali CM19
- vijačna pritrnitev vodnikov 1.5-2.5 mm<sup>2</sup>
- ustreza IEC 60884-1, CEE7

SOCKETS SET 3x SCHUKO 2P+E 16A 250V~ 7M

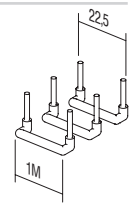
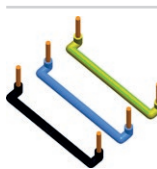
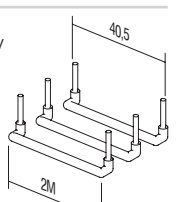
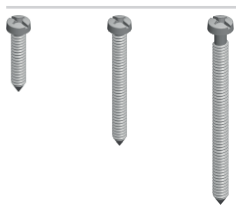
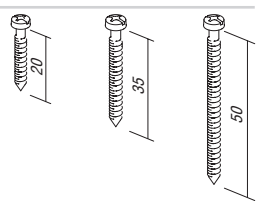
- socket set 3x schuko VM10 2P+E 16A 250V~
- prewired with link wires CM16
- with mounting frame 7M without screws
- for mounting frame fixing use screws CM17, CM18 or CM19
- screw contacts 1.5-2.5 mm<sup>2</sup>
- in accordance with IEC-60884-1, CEE7

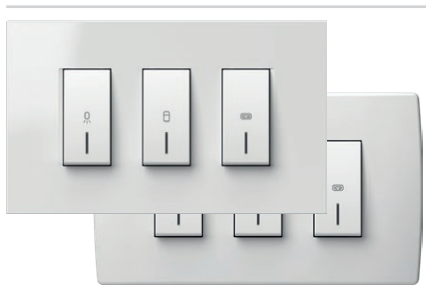
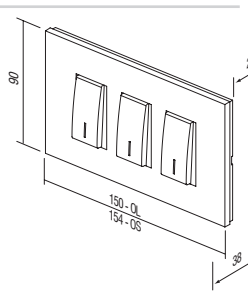

	CM15	<p><b>SET VEZNIKOV BARVNI 3x1.5mm<sup>2</sup> 1M</b></p> <ul style="list-style-type: none"> <li>- set veznikov za povezavo dveh elementov velikosti 1M</li> <li>- vsebuje 10 črnih, 10 modrih in 10 rumeno-zelenih veznikov</li> </ul> <p><b>LINK WIRE SET 3x1.5mm<sup>2</sup> 1M</b></p> <ul style="list-style-type: none"> <li>- link wire set to connect two elements size 1M</li> <li>- includes 10 black, 10 blue and 10 yellow/green wires</li> </ul>	
	CM16	<p><b>SET VEZNIKOV BARVNI 3x2.5mm<sup>2</sup> 2M</b></p> <ul style="list-style-type: none"> <li>- set veznikov za povezavo dveh elementov velikosti 2M</li> <li>- vsebuje 10 črnih, 10 modrih in 10 rumeno-zelenih veznikov</li> </ul> <p><b>LINK WIRE SET 3x2.5mm<sup>2</sup> 2M</b></p> <ul style="list-style-type: none"> <li>- link wire set to connect two elements size 2M</li> <li>- includes 10 black, 10 blue and 10 yellow/green wires</li> </ul>	
	CM17 CM18 CM19	<p><b>SET VIJAKOV 3,5</b></p> <ul style="list-style-type: none"> <li>- set vijakov za pritrnitev nosilcev setov NM30, NM32, NM40, NM41, NM70</li> <li>- CM17 - l=20mm, 100kos</li> <li>- CM18 - l=35mm, 50kos</li> <li>- CM19 - l=50mm, 50kos</li> </ul> <p><b>SCREW SET 3,5</b></p> <ul style="list-style-type: none"> <li>- screw set for fixing mounting frames NM30, NM32, NM40, NM41, NM70</li> <li>- CM17 - l=20mm, 100pcs</li> <li>- CM18 - l=35mm, 50pcs</li> <li>- CM19 - l=50mm, 50pcs</li> </ul>	
	<input type="checkbox"/> CM22PW	<p><b>SET ZA STIKALA IP44 2M</b></p> <ul style="list-style-type: none"> <li>- za vgradnjo v vlažne prostore</li> <li>- IP44 zaščito zagotavlja za vsa stikala Modul</li> <li>- stikala in tipke niso sestavni del seta</li> <li>- okvir SOFT 2M z napisno ploščico</li> <li>- ustreza IEC 60669-1</li> </ul> <p><b>SET SWITCHES IP44 2M</b></p> <ul style="list-style-type: none"> <li>- for usage in humid areas</li> <li>- IP44 protection provides for all Modul switches</li> <li>- switches and buttons are not part of the set</li> <li>- SOFT 2M cover plate with inscription plate</li> <li>- in accordance with IEC 60669-1</li> </ul>	
	<input type="checkbox"/> CM23PW	<p><b>SET ZA VTIČNICE IP44 2M</b></p> <ul style="list-style-type: none"> <li>- za vgradnjo v vlažne prostore</li> <li>- IP44 zaščito zagotavlja le v kombinaciji z vtičnico s pokrovom (VM11, VM41)</li> <li>- vtičnice niso sestavni del seta</li> <li>- okvir SOFT 2M z napisno ploščico</li> <li>- ustreza IEC 60884-1</li> </ul> <p><b>SET SOCKETS IP44 2M</b></p> <ul style="list-style-type: none"> <li>- for usage in humid areas</li> <li>- IP44 protection can be achieved only in combination with covered socket (VM11, VM41)</li> <li>- sockets are not part of the set</li> <li>- SOFT 2M cover plate with inscription plate</li> <li>- in accordance with IEC 60884-1</li> </ul>	
	<input type="checkbox"/> CM25PWOL <input type="checkbox"/> CM25IWOL  <input type="checkbox"/> CM25PWOS <input type="checkbox"/> CM25IWOS	<p><b>KOPALNIŠKI SET 3x20A 250V~ 4M</b></p> <ul style="list-style-type: none"> <li>- set stikal 3xSM12 20A 250V~ z nosilcem in okvirjem</li> <li>- vijačna pritrnitev vodnikov 1.5-2.5mm<sup>2</sup></li> <li>- ustreza EN 60669-1</li> <li>- možnost pritrditve na že vgrajene doze pritrjitvenih mer od 108 do 135mm ali na doze velikosti 4M</li> <li>- višina okvirja 90mm</li> </ul> <p><b>SWITCH SET FOR BATHROOM 3x20A 250V~ 4M</b></p> <ul style="list-style-type: none"> <li>- switch set 3xSM12 20A 250V~ with mounting frame and cover plate</li> <li>- screw contacts 1.5-2.5mm<sup>2</sup></li> <li>- in accordance with EN 60669-1</li> <li>- universal solution for renovation on boxes with fixing dimensions 108-135mm or boxes 4M size</li> <li>- cover plate height 90mm</li> </ul>	



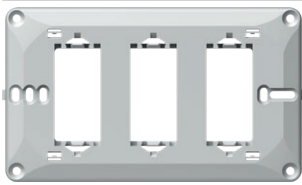

NM41





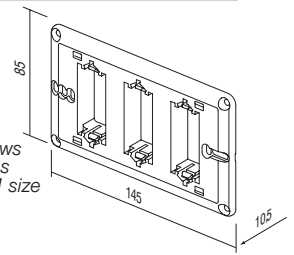

**NOSILEC KOPALNIŠKI SET 4M**

- nosilec kopalniški set univerzalni z vijaki
- možnost pritrditve na že vgrajene pravokotne doze pritrditvenih mer od 108 do 135mm ali na doze velikosti 4M
- ustreza EN 60669-1

**MOUNTING FRAME BATHROOM SET 4M**

- universal mounting frame for bathroom set with screws
- universal solution for mounting on rectangular boxes with fixing dimensions 108-135mm or boxes 4M size
- in accordance with EN 60669-1



-  OL41PW
-  OL41NB
-  OL41IW
-  OL41ES
-  OL41SG
-  OL41IB

**OKVIR LINE KOPALNIŠKI SET**

- dekorativni okvir kopalniški set LINE
- višina 90mm
- ustreza EN 60669-1

**COVER PLATE LINE BATHROOM SET**

- decorative cover plate bathroom set LINE
- height 90mm
- in accordance with EN 60669-1

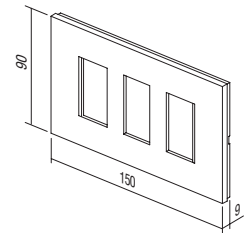

-  OS41PW
-  OS41NB
-  OS41IW
-  OS41ES
-  OS41SG
-  OS41SB
-  OS41WE

**OKVIR SOFT KOPALNIŠKI SET**

- dekorativni okvir kopalniški set SOFT
- višina 90mm
- ustreza EN 60669-1

**COVER PLATE SOFT BATHROOM SET**

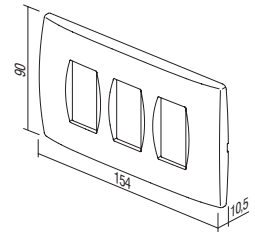

- decorative cover plate bathroom set SOFT
- height 90mm
- in accordance with EN 60669-1





# ANTIBAKTERIJSKI PROGRAM MODUL



tip type	naziv description	velikost size	barva colour	opcijski opis 1 optional data 1
TM11	TIPKA BUTTON	1M	<input type="checkbox"/> AW antibakterijsko bela antibacterial white	 NT nevtal neutral
TM21	POLNILO BLANK	1M		
VM10	VTIČNICA SOCKET	2M		 IN indikator indicator
.	.	.		
.	.	.		

## ANTIBAKTERIJSKI PROGRAM MODUL

- stikala in vtičnice so vsakodnevno izpostavljene dotiku večjega števila ljudi, zato so to pogosta mesta za razvoj in širjenje bakterij
- zahvaljujoč svojim naravnim antibakterijskim lastnostim je srebro že 3 tisočletja v uporabi kot varno in učinkovito dezinfekcijsko sredstvo, saj je popolnoma naravno ter zdravju in okolju prijazno
- poseben antibakterijski dodatek srebrovih ionov zagotavlja dolgoročno, zanesljivo in učinkovito zaščito pred razvojem in širjenjem različnih bakterij, virusov, mikrobov in glivic
- antibakterijska zaščita pomeni večjo higieničnost, čistočo in zdravje ljudi
- antibakterijski program MODUL je primeren za uporabo povsod, kjer veljajo strogi higienski pogoji (bolnišnice, zdravstveni domovi, farmacevtski objekti, domovi za starejše, negovalni domovi, laboratoriji, restavracije, hoteli, letališča, avtobusne in železniške postaje, poslovni in trgovski prostori, javne institucije ...)
- laboratorijska testiranja so bila opravljena v neodvisni instituciji na podlagi najvišjih japonskih standardov JIS Z 2801
- nizki stroški za zagotavljanje zdravja ljudi
- oblika in funkcionalnost antibakterijskega programa MODUL omogočata enostavno čiščenje in vzdrževanje
- antibakterijski program MODUL kombiniramo z antibakterijskimi tipkami, okvirji in vtičnicami skupaj s klasičnimi nosilci in stikali
- vsak izdelek je zaradi lažje identifikacije na zadnji strani označen z AW (antibacterial white)

## ANTIBACTERIAL PROGRAM MODUL

- switches and sockets are daily touched by many people, so this is a common place for development and spread of bacteria
- thanks to its natural antibacterial characteristics silver has been used for three millennia as a safe and effective disinfectant, since it is completely natural, healthy and environmentally friendly
- special antibacterial silver ions additive provides long-term, reliable and effective protection against the development and spread of bacteria, viruses, microbes and fungi
- antibacterial protection ensures hygiene, cleanliness and health for people
- perfectly suitable for use in environments with strict hygiene conditions (hospitals, health centers, pharmaceutical facilities, homes for elderly, nursing homes, laboratories, restaurants, hotels, airports, bus and railway stations, business and shopping areas, public institutions ...)
- independent laboratory testings have been carried out in accordance with highest Japanese standards JIS Z 2801
- low cost for providing human health
- design and functionality of antibacterial program MODUL allow easy cleaning and maintenance
- antibacterial buttons, cover plates and sockets are combined with classic mounting frames and switches
- products are labelled on the back with AW (antibacterial white)

## A N T I B A C T E R I A L P R O G R A M M O D U L

	□ TM11AW	<b>TIPKA 1M</b> - zamenljiva tipka velikosti 1M - ustreza EN 60669-1 - antibakterijska zaščita skladna z JIS Z 2801	
	□ TM11AWIN	<b>TIPKA 1M INDIKATOR</b> - zamenljiva tipka velikosti 1M - ustreza EN 60669-1 - antibakterijska zaščita skladna z JIS Z 2801  <b>BUTTON 1M</b> - replaceable button 1M - in accordance with EN 60669-1 - antibacterial protection in accordance with JIS Z 2801	
	□ TM12AW	<b>TIPKA 2M</b> - zamenljiva tipka velikost 2M z nosilcem tipke - uporablja se pri nadgradnji stikala ali tipkala velikosti 1M v velikost 2M - ustreza EN 60669-1 - antibakterijska zaščita skladna z JIS Z 2801  <b>BUTTON 2M</b> - replaceable button 2M with button carrier - to upgrade switch or push button from size 1M to size 2M - in accordance with EN 60669-1 - antibacterial protection in accordance with JIS Z 2801	
	□ TM12AWIN	<b>TIPKA 2M INDIKATOR</b> - zamenljiva tipka velikost 2M z nosilcem tipke - uporablja se pri nadgradnji stikala ali tipkala velikosti 1M v velikost 2M - ustreza EN 60669-1 - antibakterijska zaščita skladna z JIS Z 2801  <b>BUTTON 2M INDIKATOR</b> - replaceable button 2M with button carrier - to upgrade switch or push button from size 1M to size 2M - in accordance with EN 60669-1 - antibacterial protection in accordance with JIS Z 2801	
	□ TM21AW	<b>POLNILO 1M</b> - za zapolnjevanje praznih mest - ustreza EN 60669-1 - antibakterijska zaščita skladna z JIS Z 2801  <b>BLANK 1M</b> - blank modul to fill up empty spaces - in accordance with EN 60669-1 - antibacterial protection in accordance with JIS Z 2801	
	□ TM22AW	<b>POLNILO 2M</b> - za zapolnjevanje praznih mest - ustreza EN 60669-1 - antibakterijska zaščita skladna z JIS Z 2801  <b>BLANK 2M</b> - blank modul to fill up empty spaces - in accordance with EN 60669-1 - antibacterial protection in accordance with JIS Z 2801	





□ VM10AW

**VTIČNICA SCHUKO+KS 2P+E 16A 250V~ 2M**

- 2P+E schuko
- 16A 250V~, tip VM10
- ustreza IEC 60884-1, CEE7
- vijačna pritrditev vodnikov 1.5-2.5 mm<sup>2</sup>
- vgrajena zaščita pred dotikom kontaktov
- antibakterijska zaščita skladna z JIS Z 2801

**SOCKET SCHUKO+KS 2P+E 16A 250V~ 2M**

- 2P+E schuko
- 16A 250V~, type VM10
- in accordance with IEC 60884-1, CEE7
- screw contacts 1.5-2.5 mm<sup>2</sup>
- shuttered live contacts
- antibacterial protection in accordance with JIS Z 2801



□ VM11AW

**VTIČNICA SCHUKO+KS+POKROV 2P+E 16A 250V~ 2M**

- 2P+E schuko+pokrov
- 16A 250V~, tip VM11
- ustreza IEC 60884-1, CEE7
- vijačna pritrditev vodnikov 1.5-2.5 mm<sup>2</sup>
- vgrajena zaščita pred dotikom kontaktov
- antibakterijska zaščita skladna z JIS Z 2801

**SOCKET SCHUKO+KS+COVER**

- 2P+E schuko+cover
- 16A 250V~, type VM11
- in accordance with IEC 60884-1, CEE7
- screw contacts 1.5-2.5 mm<sup>2</sup>
- shuttered live contacts
- antibacterial protection in accordance with JIS Z 2801



□ VM20AW

**VTIČNICA EURO+KS 2P 10A 250V~ 1M**

- 2P euro
- 10A 250V~, tip VM20
- ustreza IEC 60884-1, CEE7
- vijačna pritrditev vodnikov 1.5-2.5 mm<sup>2</sup>
- vgrajena zaščita pred dotikom kontaktov
- antibakterijska zaščita skladna z JIS Z 2801

**SOCKET EURO+KS 2P 10A 250V~ 1M**

- 2P Euro
- 10A 250V~, type VM20
- in accordance with IEC 60884-1, CEE7
- screw contacts 1.5-2.5 mm<sup>2</sup>
- shuttered live contacts
- antibacterial protection in accordance with JIS Z 2801



□ KM11AW

**VTIČNICA TV KONČNA 1dB 1M**

- TV končna
- frekvenčni pas 5÷2400 MHz
- dušenje < 1 dB
- ustreza EN 50083-1
- vijačna priključitev
- antibakterijska zaščita skladna z JIS Z 2801

**SOCKET TV END-LINE 1dB 1M**

- TV end-line
- frequency range 5÷2400 MHz
- reduction < 1 dB
- in accordance with EN 50083-1
- screw contacts
- antibacterial protection in accordance with JIS Z 2801

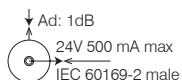

□ KM35AW

**ADAPTER KS 1M**

- KS keystone pritrditveni standard
- AMP, Avaya, Brandrex, FMT, Mfico, Tyco, ...
- komunikacijski modul ni vgrajen
- antibakterijska zaščita skladna z JIS Z 2801

**ADAPTER KS 1M**

- KS keystone fixing standard
- AMP, Avaya, Brandrex, FMT, Mfico, Tyco, ...
- communication module not included
- antibacterial protection in accordance with JIS Z 2801



## A N T I B A C T E R I A L P R O G R A M M O D U L



OS20AW

## OKVIR SOFT 2M

- dekorativni okvir SOFT 2M
- ustreza EN 60669-1
- antibakterijska zaščita skladna z JIS Z 2801

## COVER PLATE SOFT 2M

- decorative cover plate SOFT 2M
- in accordance with EN 60669-1
- antibacterial protection in accordance with JIS Z 2801



OS24AW

## OKVIR SOFT 2x2M

- dekorativni okvir SOFT 2x2M
- horizontalna ali vertikalna vgradnja
- ustreza EN 60669-1
- antibakterijska zaščita skladna z JIS Z 2801

## COVER PLATE SOFT 2x2M

- decorative cover plate SOFT 2x2M
- horizontal or vertical mounting
- in accordance with EN 60669-1
- antibacterial protection in accordance with JIS Z 2801



OS26AW

## OKVIR SOFT 3x2M

- dekorativni okvir SOFT 3x2M
- horizontalna ali vertikalna vgradnja
- ustreza EN 60669-1
- antibakterijska zaščita skladna z JIS Z 2801

## COVER PLATE SOFT 3x2M

- decorative cover plate SOFT 3x2M
- horizontal or vertical mounting
- in accordance with EN 60669-1
- antibacterial protection in accordance with JIS Z 2801



OS30AW

## OKVIR SOFT 3M

- dekorativni okvir SOFT 3M
- ustreza EN 60669-1
- antibakterijska zaščita skladna z JIS Z 2801

## COVER PLATE SOFT 3M

- decorative cover plate SOFT 3M
- in accordance with EN 60669-1
- antibacterial protection in accordance with JIS Z 2801



OS40AW

## OKVIR SOFT 4M

- dekorativni okvir SOFT 4M
- ustreza EN 60669-1
- antibakterijska zaščita skladna z JIS Z 2801

## COVER PLATE SOFT 4M

- decorative cover plate SOFT 4M
- in accordance with EN 60669-1
- antibacterial protection in accordance with JIS Z 2801

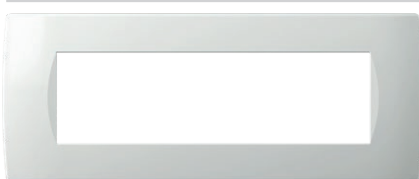

OS70AW

## OKVIR SOFT 7M

- dekorativni okvir SOFT 7M
- ustreza EN 60669-1
- antibakterijska zaščita skladna z JIS Z 2801

## COVER PLATE SOFT 7M

- decorative cover plate SOFT 7M
- in accordance with EN 60669-1
- antibacterial protection in accordance with JIS Z 2801

les  
wood

WB bambus  
bamboo



WW oreh  
walnut



WM javor  
maple



WE wenge  
wenge



**Narava je edinstvena in dragocena, kot naši okvirji, med katerimi ni enakega.**

*Reklamacij glede različnosti izgleda in medsebojnega razlikovanja pri lesenih okvirjih ne moremo upoštevati.*

**Nature is unique and precious, as our decorative cover plates where no two are the same.**

*Complaints about wooden decorative cover plate's diverse appearance and differentiation cannot be considered.*

## COVER PLATES PURE OP

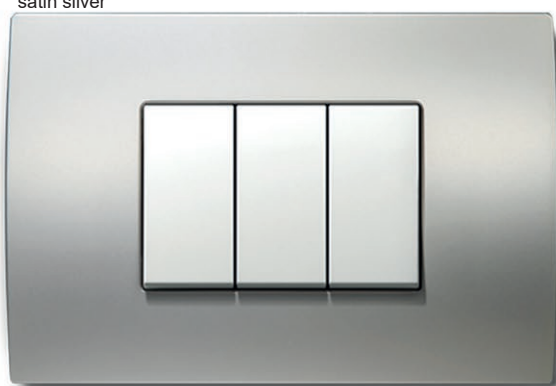
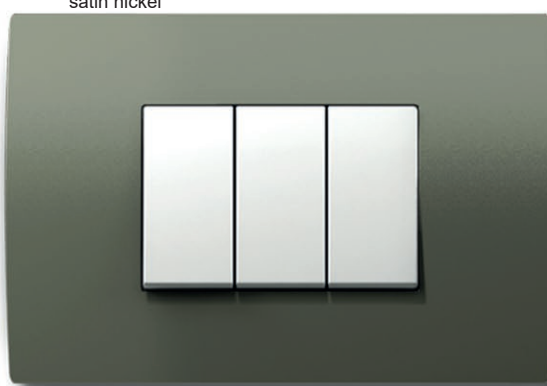
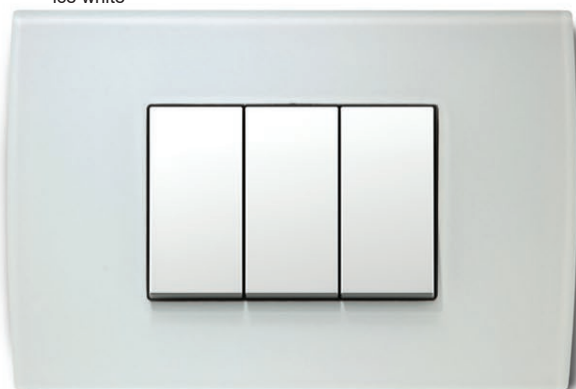
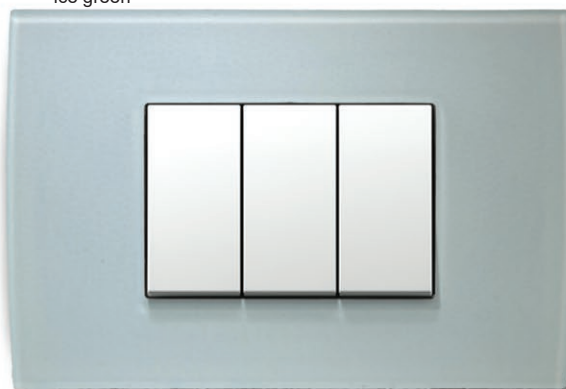
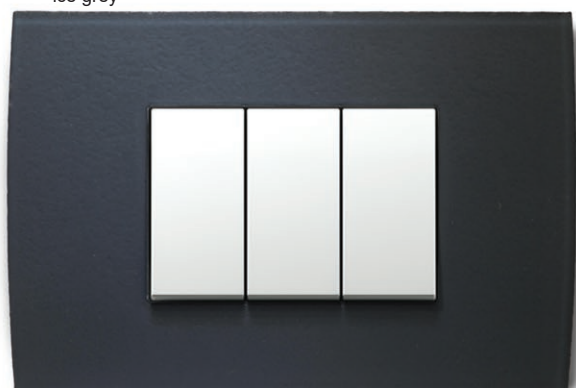
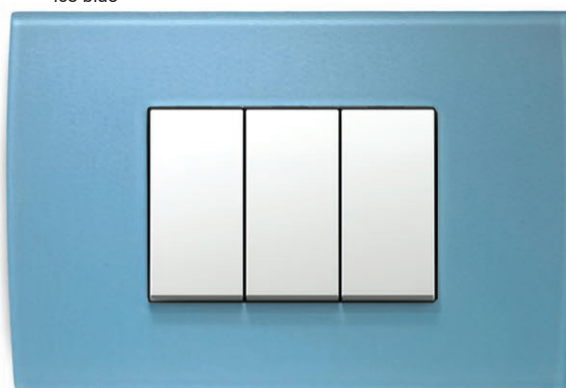
kovina  
metalMH kovano jeklo  
hammered steelME zarjavelo železo  
etched ironMS satinirano srebro  
satin silverMN satiniran nikelj  
satin nickelsteklo  
glassGW ledeno bela  
ice whiteGG ledeno zelena  
ice greenGY ledeno sive  
ice greyGB ledeno modra  
ice blue





tip type	naziv description	velikost size	barva colour	
OP13	OKVIR PURE COVER PLATE PURE	1/3M	MH kovano jeklo hammered steel	WB bambus bamboo
OP20	OKVIR PURE COVER PLATE PURE	2M	ME zarjavelo železo etched iron	WW oreh walnut
OP23	OKVIR PURE COVER PLATE PURE	2/3M	MS satinirano srebro satin silver	WM javor maple
.	.	.	MN satiniran nikelj satin nickel	WE wenge wenge
.	.	.		GW ledeno bela ice white
.	.	.		GG ledeno zelena ice green
.	.	.		GY ledeno siva ice grey
.	.	.		GB ledeno modra ice blue



OP20MH	OP20WB
OP20ME	OP20WW
OP20MS	OP20WM
OP20MN	OP20WE
	OP20GW
	OP20GG
	OP20GY
	OP20GB

**OKVIR PURE 2M**

- dekorativni okvir PURE 2M
- ustreza EN 60669-1
- samo v kombinaciji z nosilcem NM24 ali NM25

**COVER PLATE PURE 2M**

- decorative cover plate PURE 2M
- in accordance with EN 60669-1
- only in combination with mounting frames NM24 or NM25

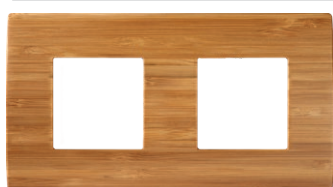

OP24MH	OP24WB
OP24ME	OP24WW
OP24MS	OP24WM
OP24MN	OP24WE
	OP24GW
	OP24GG
	OP24GY
	OP24GB

**OKVIR PURE 2x2M**

- dekorativni okvir PURE 2x2M
- horizontalna ali vertikalna vgradnja
- ustreza EN 60669-1
- samo v kombinaciji z nosilcema NM24 ali NM25

**COVER PLATE PURE 2x2M**

- decorative cover plate PURE 2x2M
- horizontal or vertical mounting
- in accordance with EN 60669-1
- only in combination with mounting frames NM24 or NM25



OP26MH	OP26WB
OP26ME	OP26WW
OP26MS	OP26WM
OP26MN	OP26WE
	OP26GW
	OP26GG
	OP26GY
	OP26GB

**OKVIR PURE 3x2M**

- dekorativni okvir PURE 3x2M
- horizontalna ali vertikalna vgradnja
- ustreza EN 60669-1
- samo v kombinaciji z nosilci NM24 ali NM25

**COVER PLATE PURE 3x2M**

- decorative cover plate PURE 3x2M
- horizontal or vertical mounting
- in accordance with EN 60669-1
- only in combination with mounting frames NM24 or NM25



OP28MH	OP28WB
OP28ME	OP28WW
OP28MS	OP28WM
OP28MN	OP28WE
	OP28GW
	OP28GG
	OP28GY
	OP28GB

**OKVIR PURE 4x2M**

- dekorativni okvir PURE 4x2M
- horizontalna ali vertikalna vgradnja
- ustreza EN 60669-1
- samo v kombinaciji z nosilci NM24 ali NM25

**COVER PLATE PURE 4x2M**

- decorative cover plate PURE 4x2M
- horizontal or vertical mounting
- in accordance with EN 60669-1
- only in combination with mounting frames NM24 or NM25

## COVER PLATES PURE OP



	OP30MH		OP30WB
	OP30ME		OP30WW
	OP30MS		OP30WM
	OP30MN		OP30WE
			OP30GW
			OP30GG
			OP30GY
			OP30GB

## OKVIR PURE 3M

- dekorativni okvir PURE 3M  
- ustreza EN 60669-1

## COVER PLATE PURE 3M

- decorative cover plate PURE 3M  
- in accordance with EN 60669-1



	OP40MH		OP40WB
	OP40ME		OP40WW
	OP40MS		OP40WM
	OP40MN		OP40WE
			OP40GW
			OP40GG
			OP40GY
			OP40GB

## OKVIR PURE 4M

- dekorativni okvir PURE 4M  
- ustreza EN 60669-1

## COVER PLATE PURE 4M

- decorative cover plate PURE 4M  
- in accordance with EN 60669-1



	OP70MH		OP70WB
	OP70ME		OP70WW
	OP70MS		OP70WM
	OP70MN		OP70WE
			OP70GW
			OP70GG
			OP70GY
			OP70GB

## OKVIR PURE 7M

- dekorativni okvir PURE 7M  
- ustreza EN 60669-1

## COVER PLATE PURE 7M

- decorative cover plate PURE 7M  
- in accordance with EN 60669-1

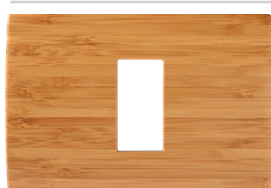

	OP13MH		OP13WB
	OP13ME		OP13WW
	OP13MS		OP13WM
	OP13MN		OP13WE
			OP13GW
			OP13GG
			OP13GY
			OP13GB

## OKVIR PURE 1/3M

- dekorativni okvir PURE 1/3M  
- ustreza EN 60669-1

## COVER PLATE PURE 1/3M

- decorative cover plate PURE 1/3M  
- in accordance with EN 60669-1

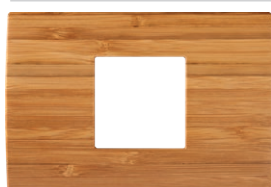

	OP23MH		OP23WB
	OP23ME		OP23WW
	OP23MS		OP23WM
	OP23MN		OP23WE
			OP23GW
			OP23GG
			OP23GY
			OP23GB

## OKVIR PURE 2/3M

- dekorativni okvir PURE 2/3M  
- ustreza EN 60669-1

## COVER PLATE PURE 2/3M

- decorative cover plate PURE 2/3M  
- in accordance with EN 60669-1

basic  
basic

PW bela-sijaj  
polar white

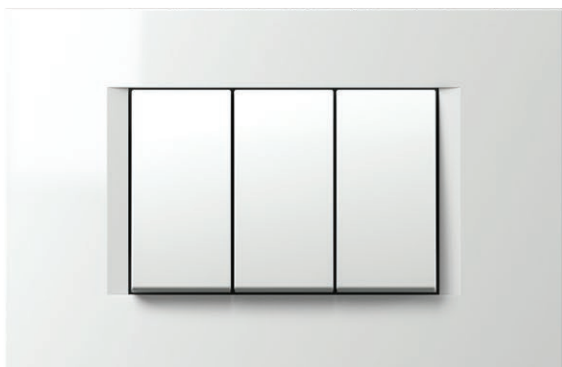

IW bež-sijaj  
ivory white

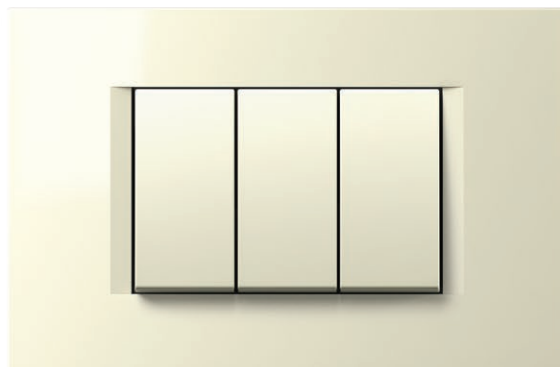

ES srebrna-mat  
elox silver



SB črna-mat  
soft touch black

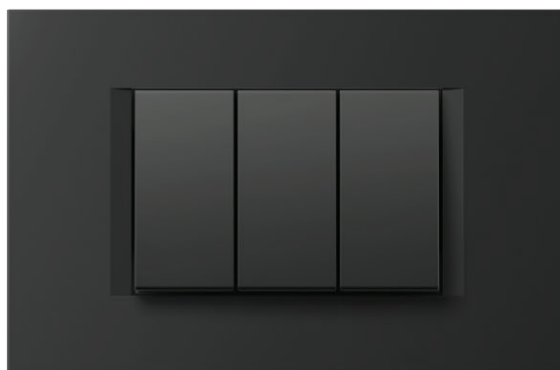

## COVER PLATES LINE OL

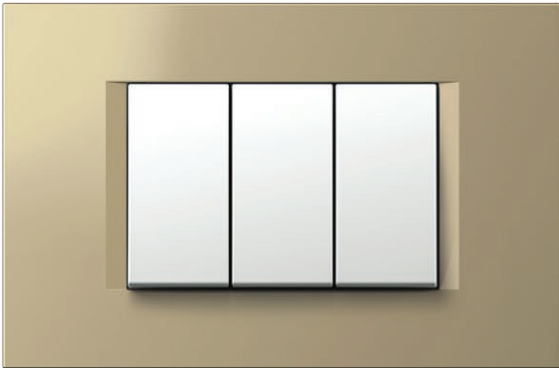
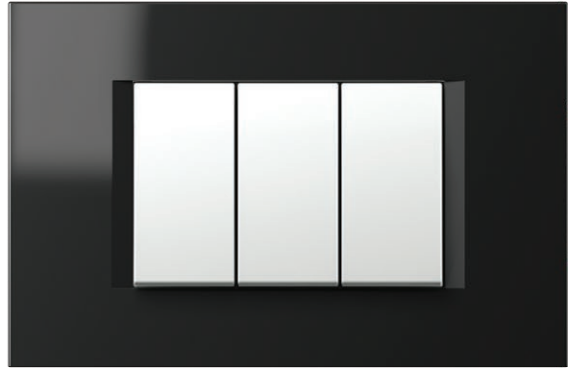
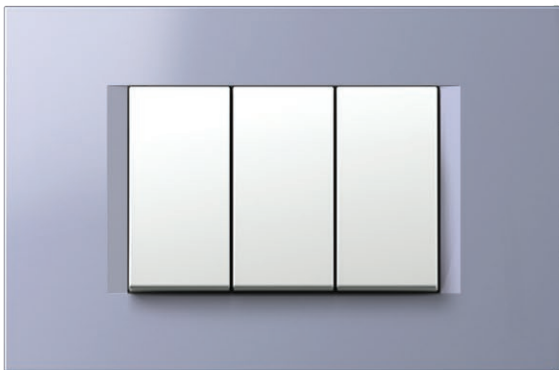
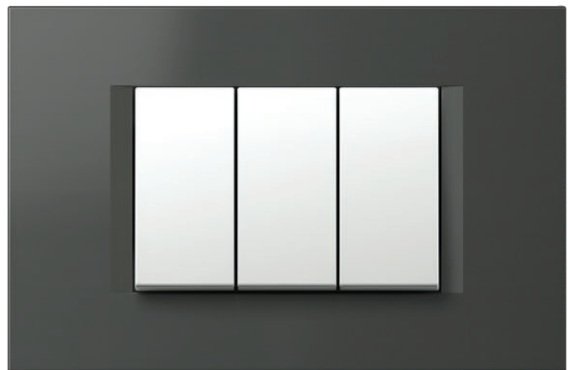
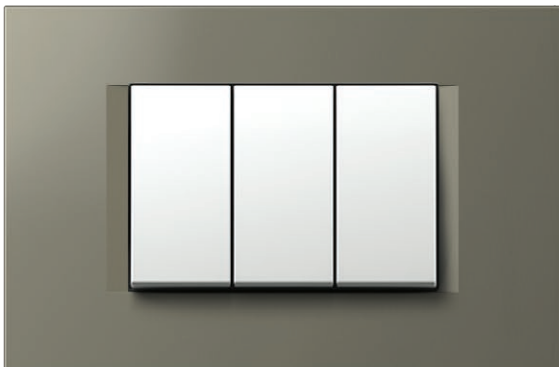
dekor  
decorSG zlata-mat  
sand goldNB črna-sijaj  
night blackIB modra-mat  
impulse blueAT antracit  
anthraciteTI titan  
titaniumSW kamen beli  
stone white



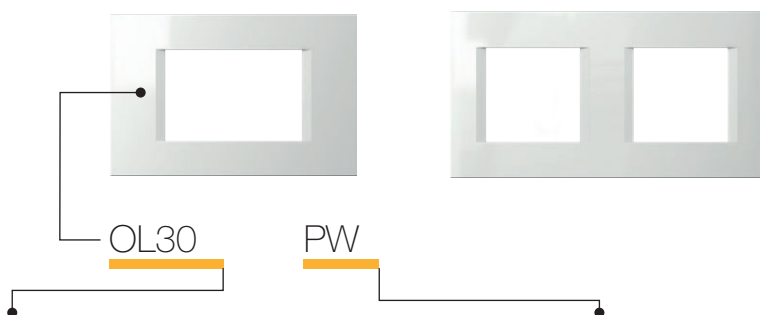

tip type	naziv description	velikost size	barva colour												
OL10	OKVIR LINE COVER PLATE LINE	1/2M	<table border="0"> <tr> <td></td> <td>PW bela-sijaj polar white</td> <td></td> <td>SG zlata-mat sand gold</td> <td></td> <td>AT antracit anthracite</td> </tr> </table>		PW bela-sijaj polar white		SG zlata-mat sand gold		AT antracit anthracite						
	PW bela-sijaj polar white		SG zlata-mat sand gold		AT antracit anthracite										
OL13	OKVIR LINE COVER PLATE LINE	1/3M	<table border="0"> <tr> <td></td> <td>IW bež-sijaj ivory white</td> <td></td> <td>NB črna-sijaj night black</td> <td></td> <td>TI titan titanium</td> </tr> </table>		IW bež-sijaj ivory white		NB črna-sijaj night black		TI titan titanium						
	IW bež-sijaj ivory white		NB črna-sijaj night black		TI titan titanium										
OL20	OKVIR LINE COVER PLATE LINE	2M	<table border="0"> <tr> <td></td> <td>ES srebrna-mat elox silver</td> <td></td> <td>IB modra-mat impulse blue</td> <td></td> <td>SW kamen beli stone white</td> </tr> <tr> <td></td> <td>SB črna-mat soft touch black</td> <td></td> <td></td> <td></td> <td></td> </tr> </table>		ES srebrna-mat elox silver		IB modra-mat impulse blue		SW kamen beli stone white		SB črna-mat soft touch black				
	ES srebrna-mat elox silver		IB modra-mat impulse blue		SW kamen beli stone white										
	SB črna-mat soft touch black														



OKVIR LINE 2M



	OL20PW		OL20SG
	OL20IW		OL20NB
	OL20ES		OL20IB
	OL20SB		OL20AT
			OL20TI
			OL20SW

- dekorativni okvir LINE 2M  
- ustreza EN 60669-1  
**COVER PLATE LINE 2M**  
- decorative cover plate LINE 2M  
- in accordance with EN 60669-1

OKVIR LINE 2x2M

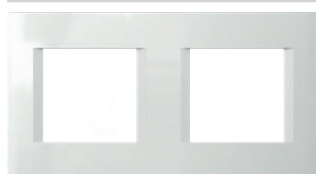

	OL24PW		OL24SG
	OL24IW		OL24NB
	OL24ES		OL24IB
	OL24SB		OL24AT
			OL24TI
			OL24SW

- dekorativni okvir LINE 2x2M  
- horizontalna ali vertikalna vgradnja  
- ustreza EN 60669-1  
**COVER PLATE LINE 2x2M**  
- decorative cover plate LINE 2x2M  
- horizontal or vertical mounting  
- in accordance with EN 60669-1

OKVIR LINE 3x2M



	OL26PW		OL26SG
	OL26IW		OL26NB
	OL26ES		OL26IB
	OL26SB		OL26AT
			OL26TI
			OL26SW

- dekorativni okvir LINE 3x2M  
- horizontalna ali vertikalna vgradnja  
- ustreza EN 60669-1  
**COVER PLATE LINE 3x2M**  
- decorative cover plate LINE 3x2M  
- horizontal or vertical mounting  
- in accordance with EN 60669-1

OKVIR LINE 4x2M



	OL28PW		OL28SG
	OL28IW		OL28NB
	OL28ES		OL28IB
	OL28SB		OL28AT
			OL28TI
			OL28SW

- dekorativni okvir LINE 4x2M  
- horizontalna ali vertikalna vgradnja  
- ustreza EN 60669-1  
**COVER PLATE LINE 4x2M**  
- decorative cover plate LINE 4x2M  
- horizontal or vertical mounting  
- in accordance with EN 60669-1

OKVIR LINE 5x2M





	OL29PW
	OL29IW
	OL29ES
	OL29SB
	OL29AT
	OL29TI

- dekorativni okvir LINE 5x2M  
- horizontalna ali vertikalna vgradnja  
- ustreza EN 60669-1  
**COVER PLATE LINE 5x2M**  
- decorative cover plate LINE 5x2M  
- horizontal or vertical mounting  
- in accordance with EN 60669-1

## COVER PLATES LINE OL



 OL30PW	 OL30SG
 OL30IW	 OL30NB
 OL30ES	 OL30IB
 OL30SB	 OL30AT
	 OL30TI
	 OL30SW







## OKVIR LINE 3M

- dekorativni okvir LINE 3M  
- ustreza EN 60669-1

## COVER PLATE LINE 3M

- decorative cover plate LINE 3M  
- in accordance with EN 60669-1



 OL40PW	 OL40SG
 OL40IW	 OL40NB
 OL40ES	 OL40IB
 OL40SB	 OL40AT
	 OL40TI
	 OL40SW



## OKVIR LINE 4M

- dekorativni okvir LINE 4M  
- ustreza EN 60669-1

## COVER PLATE LINE 4M

- decorative cover plate LINE 4M  
- in accordance with EN 60669-1



 OL70PW	 OL70SG
 OL70IW	 OL70NB
 OL70ES	 OL70IB
 OL70SB	 OL70AT
	 OL70TI
	 OL70SW

## OKVIR LINE 7M

- dekorativni okvir LINE 7M  
- ustreza EN 60669-1

## COVER PLATE LINE 7M

- decorative cover plate LINE 7M  
- in accordance with EN 60669-1



 OL10PW	 OL10SG
 OL10IW	 OL10NB
 OL10ES	 OL10IB
 OL10SB	 OL10AT
	 OL10TI
	 OL10SW









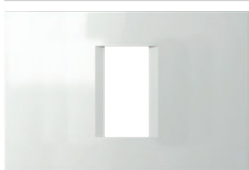

## OKVIR LINE 1/2M

- dekorativni okvir LINE 1/2M  
- ustreza EN 60669-1

## COVER PLATE LINE 1/2M

- decorative cover plate LINE 1/2M  
- in accordance with EN 60669-1



 OL13PW	 OL13SG
 OL13IW	 OL13NB
 OL13ES	 OL13IB
 OL13SB	 OL13AT
	 OL13TI
	 OL13SW











## OKVIR LINE 1/3M

- dekorativni okvir LINE 1/3M  
- ustreza EN 60669-1

## COVER PLATE LINE 1/3M

- decorative cover plate LINE 1/3M  
- in accordance with EN 60669-1



 OL23PW	 OL23SG
 OL23IW	 OL23NB
 OL23ES	 OL23IB
 OL23SB	 OL23AT
	 OL23TI
	 OL23SW

## OKVIR LINE 2/3M

- dekorativni okvir LINE 2/3M  
- ustreza EN 60669-1

## COVER PLATE LINE 2/3M

- decorative cover plate LINE 2/3M  
- in accordance with EN 60669-1

basic  
basic

PW bela-sijaj  
polar white

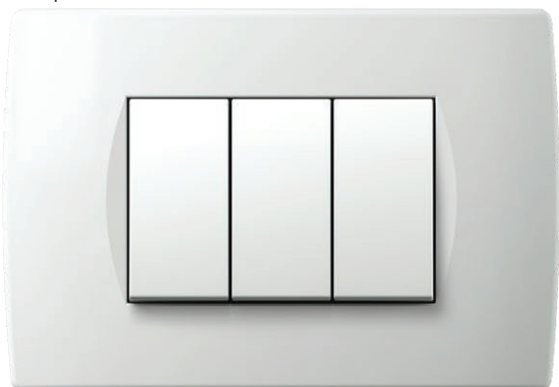

IW bež-sijaj  
ivory white

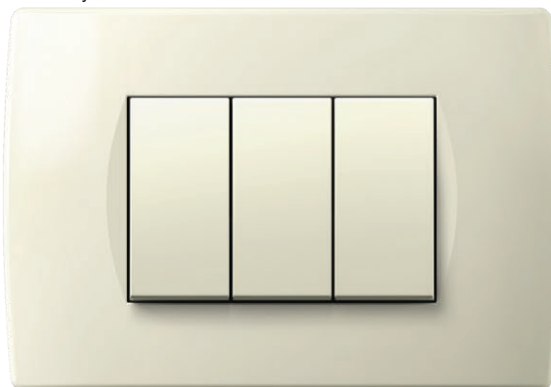

ES srebrna-mat  
elox silver

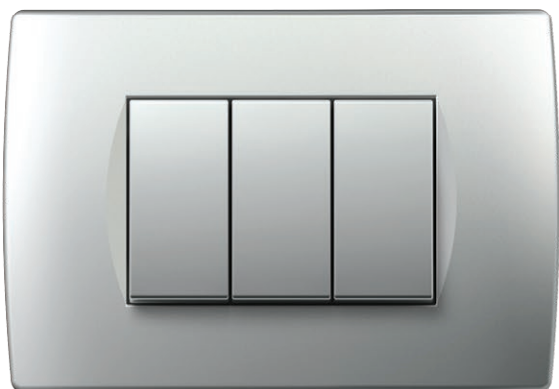

SB črna-mat  
soft touch black

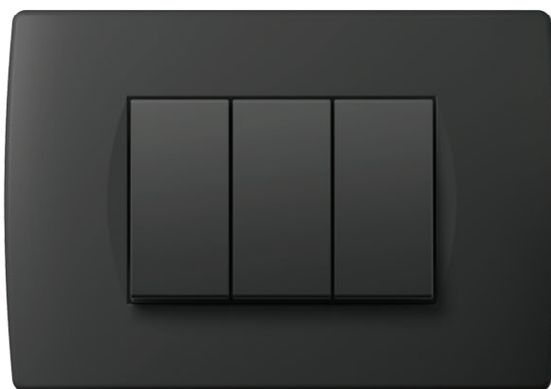

## COVER PLATES SOFT OS

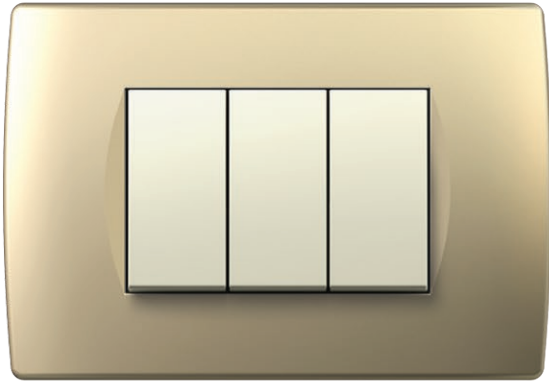
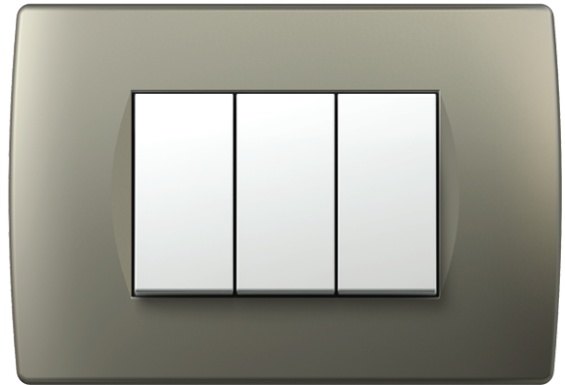
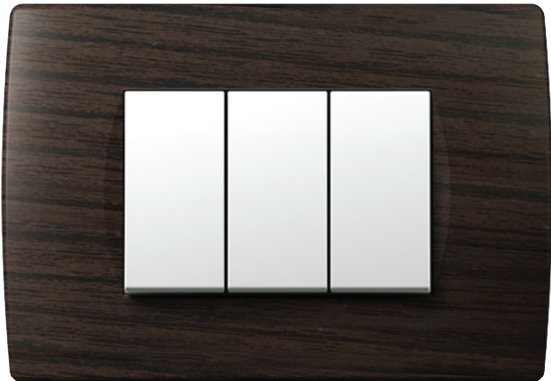
dekor  
decorSG zlata-mat  
sand goldNB črna-sijaj  
night blackAT antracit  
anthraciteTI titan  
titaniumWE wenge  
wengeWW oreh  
walnut



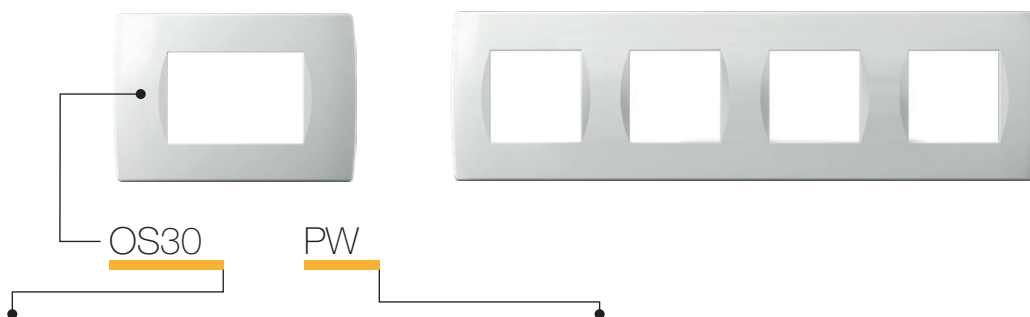

tip type	naziv description	velikost size	barva colour												
OS10	OKVIR SOFT COVER PLATE SOFT	1/2M	<table border="0"> <tr> <td></td> <td>PW bela-sijaj polar white</td> <td></td> <td>SG zlata-mat sand gold</td> <td></td> <td>WW oreh walnut</td> </tr> </table>		PW bela-sijaj polar white		SG zlata-mat sand gold		WW oreh walnut						
	PW bela-sijaj polar white		SG zlata-mat sand gold		WW oreh walnut										
OS13	OKVIR SOFT COVER PLATE SOFT	1/3M	<table border="0"> <tr> <td></td> <td>IW bež-sijaj ivory white</td> <td></td> <td>NB črna-sijaj night black</td> <td></td> <td>WE wenge wenge</td> </tr> </table>		IW bež-sijaj ivory white		NB črna-sijaj night black		WE wenge wenge						
	IW bež-sijaj ivory white		NB črna-sijaj night black		WE wenge wenge										
OS20	OKVIR SOFT COVER PLATE SOFT	2M	<table border="0"> <tr> <td></td> <td>ES srebrna-mat elox silver</td> <td></td> <td>AT antracit anthracite</td> <td></td> <td></td> </tr> <tr> <td></td> <td>SB črna-mat soft touch black</td> <td></td> <td>TI titan titanium</td> <td></td> <td></td> </tr> </table>		ES srebrna-mat elox silver		AT antracit anthracite				SB črna-mat soft touch black		TI titan titanium		
	ES srebrna-mat elox silver		AT antracit anthracite												
	SB črna-mat soft touch black		TI titan titanium												
...	...	...	...												



**OKVIR SOFT 2M**



	OS20PW		OS20SG
	OS20IW		OS20NB
	OS20ES		OS20AT
	OS20SB		OS20TI
			OS20WW
			OS20WE

- dekorativni okvir SOFT 2M  
- ustreza EN 60669-1

**COVER PLATE SOFT 2M**

- decorative cover plate SOFT 2M  
- in accordance with EN 60669-1

**OKVIR SOFT 2x2M**



	OS24PW		OS24SG
	OS24IW		OS24NB
	OS24ES		OS24AT
	OS24SB		OS24TI
			OS24WW
			OS24WE

- dekorativni okvir SOFT 2x2M  
- horizontalna ali vertikalna vgradnja  
- ustreza EN 60669-1

**COVER PLATE SOFT 2x2M**

- decorative cover plate SOFT 2x2M  
- horizontal or vertical mounting  
- in accordance with EN 60669-1

**OKVIR SOFT 3x2M**

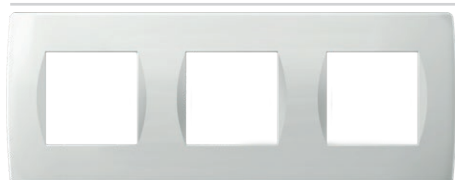

	OS26PW		OS26SG
	OS26IW		OS26NB
	OS26ES		OS26AT
	OS26SB		OS26TI
			OS26WW
			OS26WE

- dekorativni okvir SOFT 3x2M  
- horizontalna ali vertikalna vgradnja  
- ustreza EN 60669-1

**COVER PLATE SOFT 3x2M**

- decorative cover plate SOFT 3x2M  
- horizontal or vertical mounting  
- in accordance with EN 60669-1

**OKVIR SOFT 4x2M**



	OS28PW		OS28SG
	OS28IW		OS28NB
	OS28ES		OS28AT
	OS28SB		OS28TI
			OS28WW
			OS28WE

- dekorativni okvir SOFT 4x2M  
- horizontalna ali vertikalna vgradnja  
- ustreza EN 60669-1

**COVER PLATE SOFT 4x2M**

- decorative cover plate SOFT 4x2M  
- horizontal or vertical mounting  
- in accordance with EN 60669-1

## COVER PLATES SOFT OS



 OS30PW	 OS30SG
 OS30IW	 OS30NB
 OS30ES	 OS30AT
 OS30SB	 OS30TI
	 OS30WW
	 OS30WE





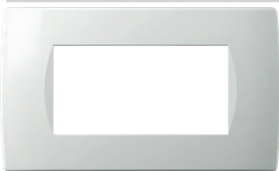

## OKVIR SOFT 3M

- dekorativni okvir SOFT 3M  
- ustreza EN 60669-1

## COVER PLATE SOFT 3M

- decorative cover plate SOFT 3M  
- in accordance with EN 60669-1



 OS40PW	 OS40SG
 OS40IW	 OS40NB
 OS40ES	 OS40AT
 OS40SB	 OS40TI
	 OS40WW
	 OS40WE





## OKVIR SOFT 4M

- dekorativni okvir SOFT 4M  
- ustreza EN 60669-1

## COVER PLATE SOFT 4M

- decorative cover plate SOFT 4M  
- in accordance with EN 60669-1



 OS70PW	 OS70SG
 OS70IW	 OS70NB
 OS70ES	 OS70AT
 OS70SB	 OS70TI
	 OS70WW
	 OS70WE

## OKVIR SOFT 7M

- dekorativni okvir SOFT 7M  
- ustreza EN 60669-1

## COVER PLATE SOFT 7M

- decorative cover plate SOFT 7M  
- in accordance with EN 60669-1



 OS72PW	 OS72AT
 OS72IW	 OS72TI
 OS72ES	
 OS72SB	

## OKVIR SOFT 2x7M

- dekorativni okvir SOFT 2x7M z  
napisno ploščico  
- ustreza EN 60669-1

## COVER PLATE SOFT 2x7M

- decorative cover plate SOFT 2x7M  
with inscription plate  
- in accordance with EN 60669-1



 OS10PW	 OS10SG
 OS10IW	 OS10NB
 OS10ES	 OS10AT
 OS10SB	 OS10TI
	 OS10WW
	 OS10WE









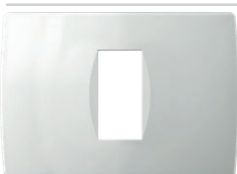

## OKVIR SOFT 1/2M

- dekorativni okvir SOFT 1/2M  
- ustreza EN 60669-1

## COVER PLATE SOFT 1/2M

- decorative cover plate SOFT 1/2M  
- in accordance with EN 60669-1



 OS13PW	 OS13SG
 OS13IW	 OS13NB
 OS13ES	 OS13AT
 OS13SB	 OS13TI
	 OS13WW
	 OS13WE

## OKVIR SOFT 1/3M

- dekorativni okvir SOFT 1/3M  
- ustreza EN 60669-1

## COVER PLATE SOFT 1/3M

- decorative cover plate SOFT 1/3M  
- in accordance with EN 60669-1

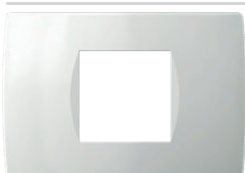

 OS23PW	 OS23SG
 OS23IW	 OS23NB
 OS23ES	 OS23AT
 OS23SB	 OS23TI
	 OS23WW
	 OS23WE

## OKVIR SOFT 2/3M

- dekorativni okvir SOFT 2/3M  
- ustreza EN 60669-1

## COVER PLATE SOFT 2/3M

- decorative cover plate SOFT 2/3M  
- in accordance with EN 60669-1



LASERSKI TISK NA OKVIRJE

- laserski tisk poljubne grafike
- izdelava po naročilu
- primerno za okvirje OL, OS

LASER PRINT ON COVER PLATES

- laser print of any graphics
- made on request
- suitable for cover plates OL, OS



DEKORACIJE OKVIRJEV





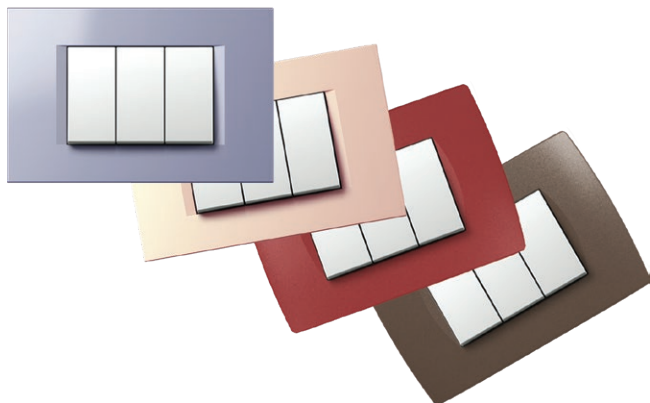

- vzorci in barve po izbiri
- izdelava po naročilu
- primerno za okvirje OL, OS

COVER PLATES DECORATIONS

- customised textures and colours
- made on request
- suitable for cover plates OL, OS

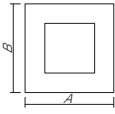
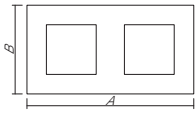
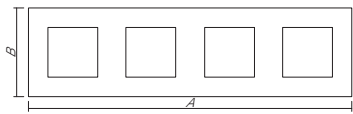
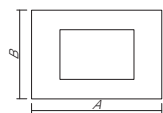
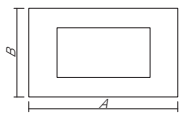
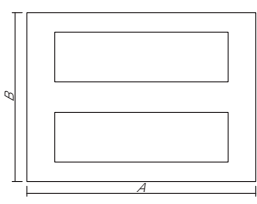

F R A M E S

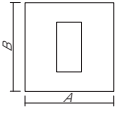
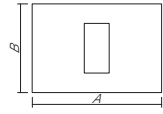
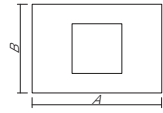
	 line A x B	 soft A x B	 PURE A x B
2M 	80 x 80 mm	84 x 84 mm	93 x 90 mm
2x2M 	151 x 80 mm	155 x 84 mm	164 x 90 mm
3x2M 	222 x 80 mm	226 x 84 mm	235 x 90 mm
4x2M 	293 x 80 mm	297 x 84 mm	304 x 90 mm
 3M 	122 x 80 mm	122 x 84 mm	134 x 90 mm
4M 	149 x 80 mm	144 x 84 mm	157 x 90 mm
7M 	207 x 80 mm	212 x 84 mm	224 x 90 mm
2x7M 		212 x 158 mm	
 1/2M 	80 x 80 mm	84 x 84 mm	
1/3M 	122 x 80 mm	122 x 84 mm	134 x 90 mm
2/3M 	122 x 80 mm	122 x 84 mm	134 x 90 mm



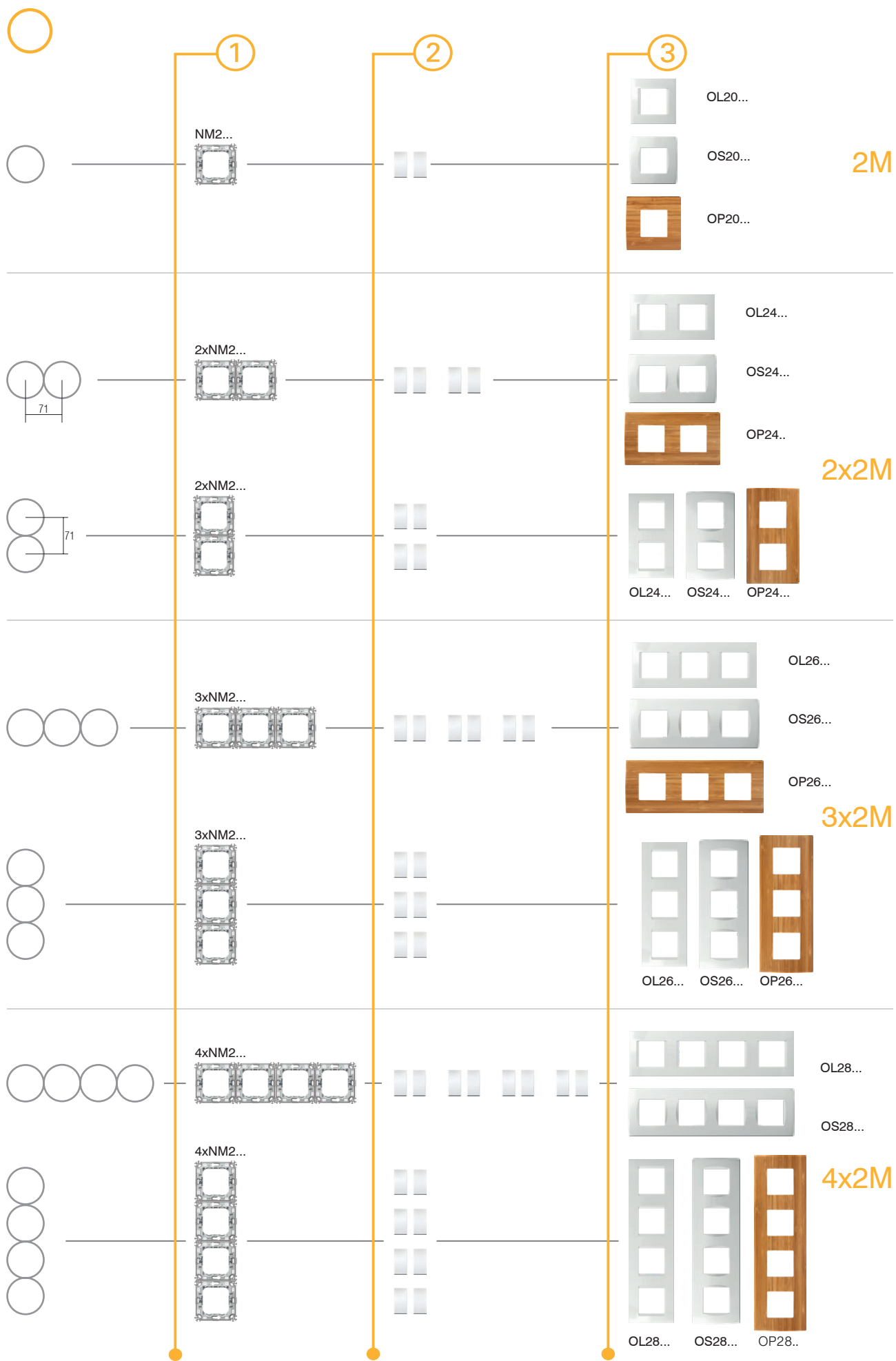

C O M B I N A T I O N S

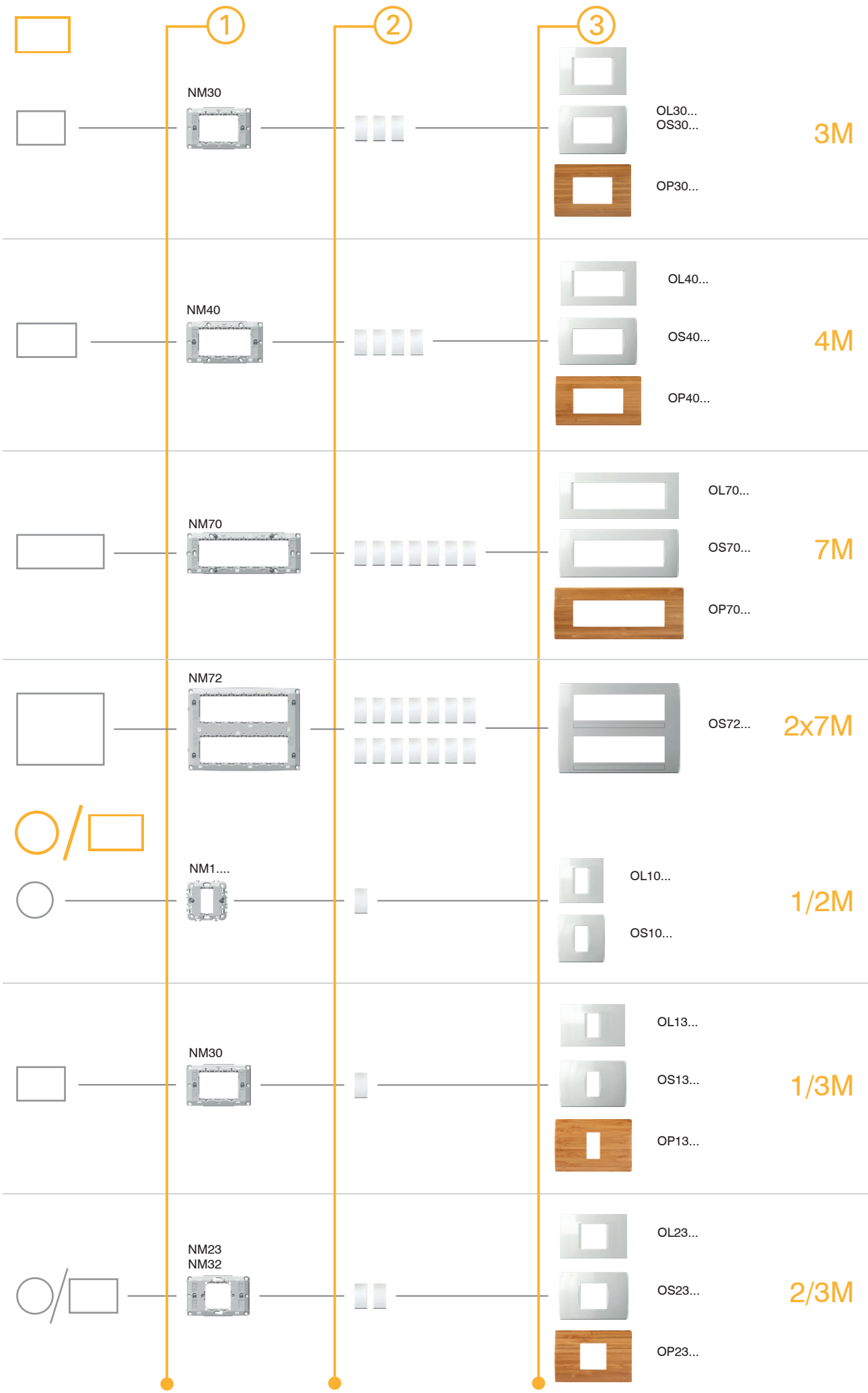

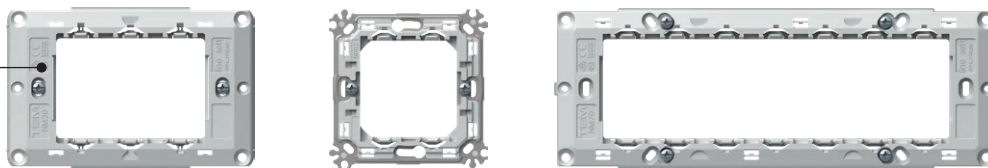

NM30

tip type	naziv description	velikost size
NM10	NOSILEC S KREPELJCI MOUNTING FRAME WITH CLAWS	1/2M
NM11	NOSILEC BREZ VIJAKOV MOUNTING FRAME WITHOUT SCREWS	1/2M
NM20	NOSILEC S KREPELJCI MOUNTING FRAME WITH CLAWS	2M
...	...	...



**NOSILEC S KREPELJCI 2M**

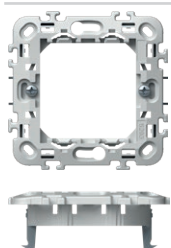

NM20

- nosilec 2M s krepeljci
- montaža v doze Ø60 (DE..) s krepeljci
- možno horizontalno ali vertikalno nizanje 2x2M, 3x2M in 4x2M
- primeren za sestavo z okvirji LINE in SOFT
- ustreza EN 60669-1

**MOUNTING FRAME WITH CLAWS 2M**

- mounting frame 2M with claws
- for mounting on boxes Ø60 (DE..) with claws
- possible horizontal or vertical combinations 2x2M, 3x2M and 4x2M
- suitable for assembling with cover plates LINE and SOFT
- in accordance with EN 60669-1

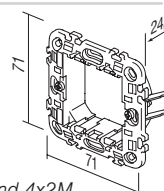

**NOSILEC BREZ VIJAKOV 2M**

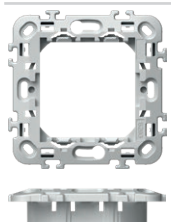

NM21

- nosilec 2M brez vijakov in brez krepeljcev
- montaža v doze Ø60 (HE.., BE..) z vijaki
- možno horizontalno ali vertikalno nizanje 2x2M, 3x2M in 4x2M
- primeren za sestavo z okvirji LINE in SOFT
- ustreza EN 60669-1

**MOUNTING FRAME WITHOUT SCREWS 2M**

- mounting frame 2M without screws and without claws
- for mounting on boxes Ø60 (HE.., BE..) with screws
- possible horizontal or vertical combinations 2x2M, 3x2M and 4x2M
- suitable for assembling with cover plates LINE and SOFT
- in accordance with EN 60669-1

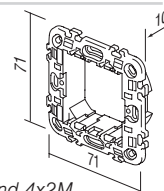

**NOSILEC KOVINSKI S KREPELJCI 2M**

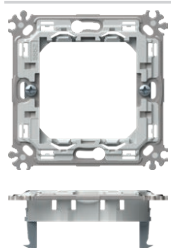

NM24

- kovinski nosilec 2M s krepeljci - toga izvedba
- montaža v doze Ø60 (DE..) s krepeljci
- možno horizontalno ali vertikalno nizanje 2x2M, 3x2M in 4x2M
- primeren za sestavo z okvirji PURE, LINE in SOFT
- ustreza EN 60669-1

**MOUNTING FRAME METAL WITH CLAWS 2M**

- metal mounting frame 2M with claws - stiff version
- for mounting on boxes Ø60 (DE..) with claws
- possible horizontal or vertical combinations 2x2M, 3x2M and 4x2M
- suitable for assembling with cover plates PURE, LINE and SOFT
- in accordance with EN 60669-1

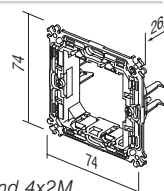

**NOSILEC KOVINSKI BREZ VIJAKOV 2M**

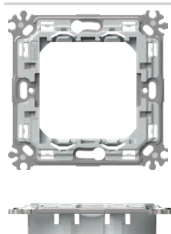

NM25

- kovinski nosilec brez vijakov in brez krepeljcev - toga izvedba
- montaža v doze Ø60 (HE.., BE..) z vijaki
- možno horizontalno ali vertikalno nizanje 2x2M, 3x2M in 4x2M
- primeren za sestavo z okvirji PURE, LINE in SOFT
- ustreza EN 60669-1

**MOUNTING FRAME METAL WITHOUT SCREWS 2M**

- metal mounting frame 2M without screws and without claws - stiff version
- for mounting in boxes Ø60 (HE..., BE...) with screws
- possible horizontal or vertical combinations 2x2M, 3x2M and 4x2M
- suitable for assembling with cover plates PURE, LINE and SOFT
- in accordance with EN 60669-1

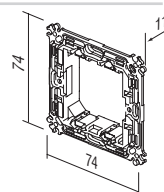



NM30

**NOSILEC Z VIJAKI 3M**

- nosilec 3M z vijaki
- montaža v pravokotne doze velikosti 3M
- primeren za sestavo z okvirji PURE, LINE in SOFT
- ustreza EN 60669-1

**MOUNTING FRAME WITH SCREWS 3M**

- mounting frame 3M with screws
- for mounting on rectangular boxes 3M
- suitable for assembling with cover plates PURE, LINE and SOFT
- in accordance with EN 60669-1

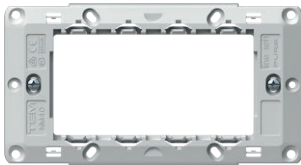
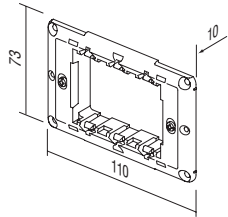

NM40

**NOSILEC Z VIJAKI 4M**

- nosilec 4M z vijaki
- montaža v pravokotne doze velikosti 4M
- primeren za sestavo z okvirji PURE, LINE in SOFT
- ustreza EN 60669-1

**MOUNTING FRAME WITH SCREWS 4M**

- mounting frame 4M with screws
- for mounting on rectangular boxes 4M
- suitable for assembling with cover plates PURE, LINE and SOFT
- in accordance with EN 60669-1

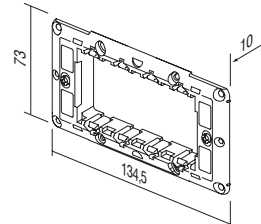

NM70

**NOSILEC Z VIJAKI 7M**

- nosilec 7M z vijaki
- montaža v pravokotne doze velikosti 7M
- primeren za sestavo z okvirji PURE, LINE in SOFT
- ustreza EN 60669-1

**MOUNTING FRAME WITH SCREWS 7M**

- mounting frame 7M with screws
- for mounting on rectangular boxes 7M
- suitable for assembling with cover plates PURE, LINE and SOFT
- in accordance with EN 60669-1

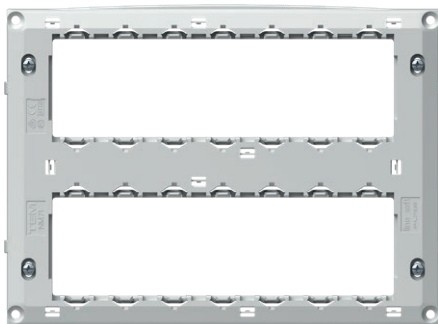
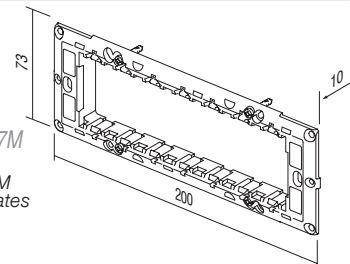

NM72

**NOSILEC Z VIJAKI 2x7M**

- nosilec 2x7M z vijaki
- montaža v pravokotne doze velikosti 2x7M
- primeren za sestavo z okvirjem SOFT OS72
- ustreza EN 60669-1

**MOUNTING FRAME WITH SCREWS 2x7M**

- mounting frame 2x7M with screws
- for mounting on rectangular boxes 2x7M
- suitable for assembling with cover plate SOFT OS72
- in accordance with EN 60669-1

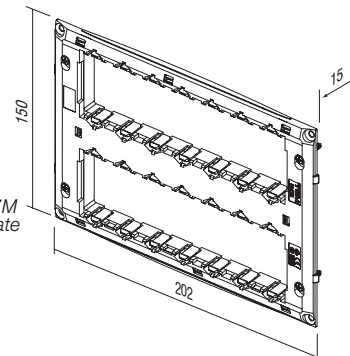





**NOSILEC S KREPELJCI 1/2M**

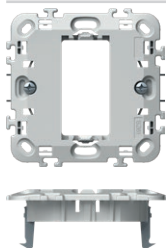

NM10

- nosilec 1/2M s krepeljci
- montaža v doze Ø60 (DE..) s krepeljci
- primeren za sestavo z okvirji LINE in SOFT
- ustreza EN 60669-1

**MOUNTING FRAME WITH CLAWS 1/2M**

- mounting frame 1/2M with claws
- for mounting on boxes Ø60 (DE..) with claws
- suitable for assembling with cover plates LINE and SOFT
- in accordance with EN 60669-1

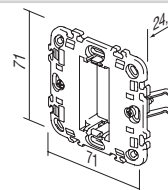

**NOSILEC BREZ VIJAKOV 1/2M**

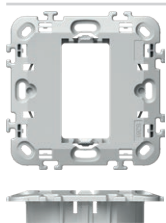

NM11

- nosilec 1/2M brez vijakov in brez krepeljev
- montaža v doze Ø60 (HE.., BE..) z vijaki
- primeren za sestavo z okvirji LINE in SOFT
- ustreza EN 60669-1

**MOUNTING FRAME WITHOUT SCREWS 1/2M**

- mounting frame 1/2M without screws and without claws
- for mounting on boxes Ø60 (HE.., BE..) with screws
- suitable for assembling with cover plates LINE and SOFT
- in accordance with EN 60669-1

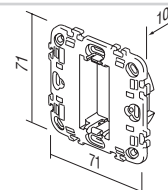

**NOSILEC S KREPELJCI 2/3M**

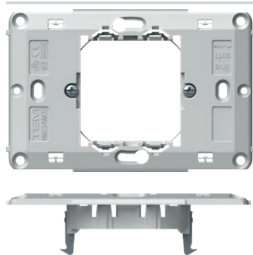

NM23

- nosilec 2/3M s krepeljci
- montaža v doze Ø60 (DE..) s krepeljci
- primeren za sestavo z okvirji PURE, LINE in SOFT
- ustreza EN 60669-1

**MOUNTING FRAME WITH CLAWS 2/3M**

- mounting frame 2/3M with claws
- for mounting on boxes Ø60 (DE..) with claws
- suitable for assembling with cover plates PURE, LINE and SOFT
- in accordance with EN 60669-1

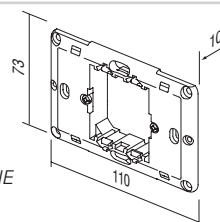

**NOSILEC Z VIJAKI 2/3M**

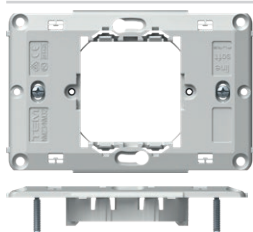

NM32

- nosilec 2/3M z vijaki
- montaža v pravokotne doze velikosti 3M
- primeren za sestavo z okvirji PURE, LINE in SOFT
- ustreza EN 60669-1

**MOUNTING FRAME WITH SCREWS 2/3M**

- mounting frame 2/3M with screws
- for mounting on rectangular boxes 3M
- suitable for assembling with cover plates PURE, LINE and SOFT
- in accordance with EN 60669-1

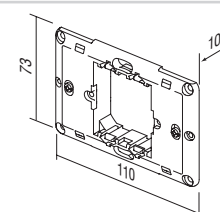



TEM

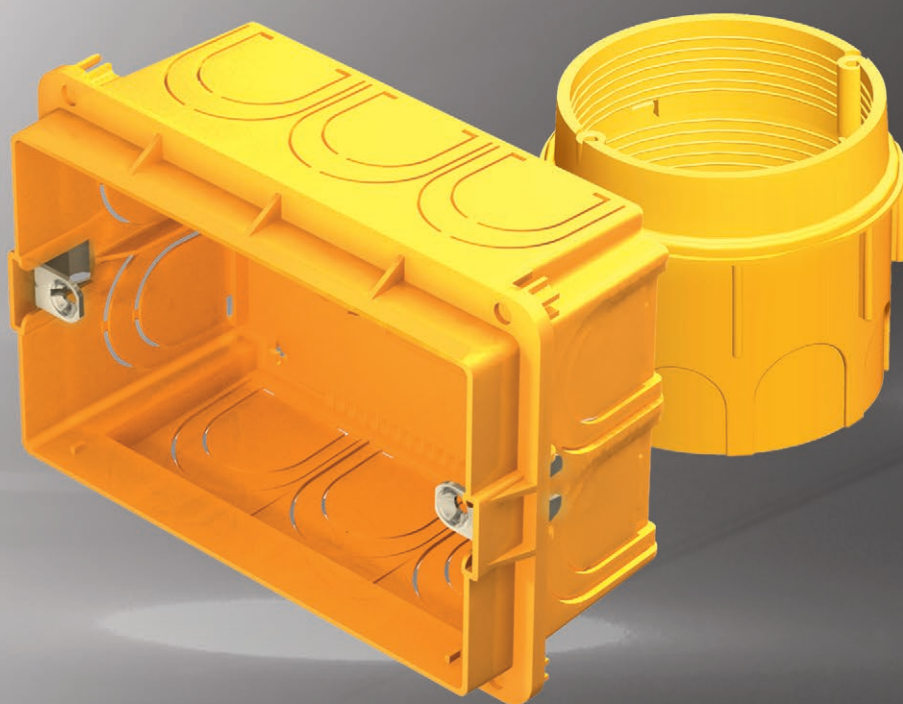



---

OKROGLE DOZE  
*ROUND BOXES*



140

---

PRAVOKOTNE DOZE  
*RECTANGULAR BOXES*



148

---

RAZVODNE DOZE  
*JUNCTION BOXES*



156

---

PRIBOR ZA OŽIČENJE  
*WIRING ACCESSORIES*



158





DE12



HE11



BE10

tip type	naziv description	velikost size
DE10	DOZA OKROGLA ZA ZID ROUND BOX BRICK	SM60-01
HE10	DOZA OKROGLA ZA VOTLE STENE ROUND BOX HOLLOW WALL	SM68X40
BE10	DOZA OKROGLA ZA BETON ROUND BOX CONCRETE	
:	:	:
:	:	:

**DOZA OKROGLA ZA ZID SM60-01**



DE10

- Ø60, globina 40mm
- 650°C, 500V~
- ustreza IEC 60670-1
- "halogen free"

**ROUND BOX BRICK SM60-01**

- Ø60, depth 40mm
- 650°C, 500V~
- in accordance with IEC 60670-1
- halogen free

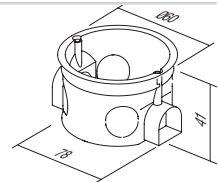

**DOZA OKROGLA ZA ZID GLOBOKA SM60-06**



DE11

- Ø60, globina 60mm
- 650°C, 500V~
- ustreza IEC 60670-1
- "halogen free"

**ROUND BOX BRICK DEEP SM60-06**

- Ø60, depth 60mm
- 650°C, 500V~
- in accordance with IEC 60670-1
- halogen free

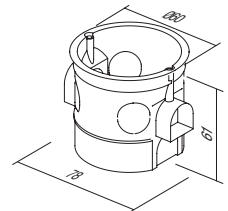

**VEZNI ČLEN DOZE ZA ZID SM60-03**



DE30

- za vertikalno povezavo doz SM60-06 ali SM60-01
- na razdaljo 91 mm
- ustreza IEC 60670-1
- "halogen free"

**COMBI-CLIP SM60-03**

- for vertical fitting of boxes SM60-06 or SM60-01 on distance 91 mm
- in accordance with IEC 60670-1
- halogen free

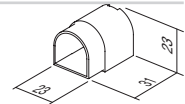

**VEZNI ČLEN DOZE ZA ZID SM60-04**

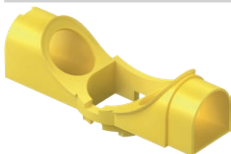

DE31







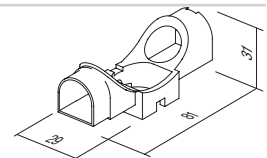



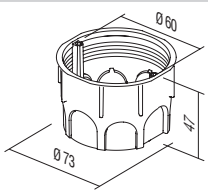

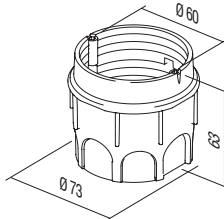

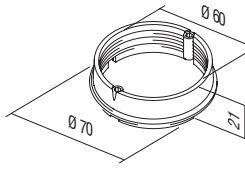
- za horizontalno povezavo doz SM60-06 ali SM60-01
- na razdaljo 71mm
- ustreza IEC 60670-1
- "halogen free"

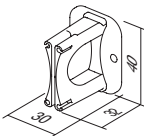
**COMBI-CLIP SM60-04**

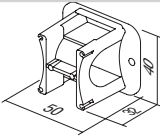
- for horizontal fitting of boxes SM60-06 or SM60-01 on distance 71mm
- in accordance with IEC 60670-1
- halogen free

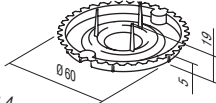

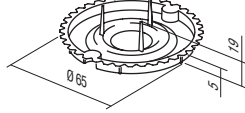
## R O U N D     B O X E S

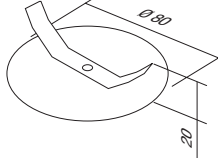
	DE12	<p><b>DOZA OKROGLA ZA ZID MD65-46</b></p> <ul style="list-style-type: none"> <li>- Ø65, globina 46mm</li> <li>- 650°C, 500V</li> <li>- ustreza IEC 60670-1</li> <li>- "halogen free"</li> </ul> <p><i>ROUND BOX BRICK MD65-46</i></p> <ul style="list-style-type: none"> <li>- Ø65, depth 46mm</li> <li>- 650°C, 500V</li> <li>- in accordance with IEC 60670-1</li> <li>- halogen free</li> </ul>	
	DE13	<p><b>DOZA OKROGLA ZA ZID GLOBOKA MD65-60</b></p> <ul style="list-style-type: none"> <li>- Ø65/60, globina 62mm</li> <li>- 650°C, 500V</li> <li>- ustreza IEC 60670-1</li> <li>- "halogen free"</li> </ul> <p><i>ROUND BOX BRICK DEEP MD65-60</i></p> <ul style="list-style-type: none"> <li>- Ø65/60, depth 62mm</li> <li>- 650°C, 500V</li> <li>- in accordance with IEC 60670-1</li> <li>- halogen free</li> </ul>	
	DE14	<p><b>PODALJŠEK DOZE ZA ZID MD65-46</b></p> <ul style="list-style-type: none"> <li>- Ø65/60, globina 17mm</li> <li>- 650°C, 500V</li> <li>- ustreza IEC 60670-1</li> <li>- "halogen free"</li> </ul> <p><i>ADDITIONAL PIECE FOR MD65-46</i></p> <ul style="list-style-type: none"> <li>- Ø65/60, depth 17mm</li> <li>- 650°C, 500V</li> <li>- in accordance with IEC 60670-1</li> <li>- halogen free</li> </ul>	
	DE32	<p><b>VEZNI ČLEN DOZE ZA ZID MD65-71</b></p> <ul style="list-style-type: none"> <li>- za povezavo doz MD65 na razdaljo 71 mm</li> <li>- ustreza IEC 60670-1</li> <li>- "halogen free"</li> </ul> <p><i>COMBI-CLIP MD65-71</i></p> <ul style="list-style-type: none"> <li>- for fitting of boxes MD65 on distance 71mm</li> <li>- in accordance with IEC 60670-1</li> <li>- halogen free</li> </ul>	
	DE33	<p><b>VEZNI ČLEN DOZE ZA ZID MD65-91</b></p> <ul style="list-style-type: none"> <li>- za povezavo doz MD65 na razdaljo 91mm</li> <li>- ustreza IEC 60670-1</li> <li>- "halogen free"</li> </ul> <p><i>COMBI-CLIP MD65-91</i></p> <ul style="list-style-type: none"> <li>- for fitting of boxes MD65 on distance 91mm</li> <li>- in accordance with IEC 60670-1</li> <li>- halogen free</li> </ul>	
	DE20	<p><b>POKROV DOZE ZAŠČITNI 60</b></p> <ul style="list-style-type: none"> <li>- zaščitni pokrov doze Ø60 za DE10, DE11, DE13, DE14</li> <li>- ustreza IEC 60670-1</li> <li>- za zaščito pri ometavanju</li> </ul> <p><i>BOX COVER PROTECTIVE 60</i></p> <ul style="list-style-type: none"> <li>- protective cover for box Ø60 for DE10, DE11, DE13, DE14</li> <li>- in accordance with IEC 60670-1</li> <li>- box protection during plastering</li> </ul>	
	DE21	<p><b>POKROV DOZE ZAŠČITNI 65</b></p> <ul style="list-style-type: none"> <li>- zaščitni pokrov doze Ø65 za DE12</li> <li>- ustreza IEC 60670-1</li> <li>- za zaščito pri ometavanju</li> </ul> <p><i>BOX COVER PROTECTIVE 65</i></p> <ul style="list-style-type: none"> <li>- protective cover for box Ø65 for DE12</li> <li>- in accordance with IEC 60670-1</li> <li>- box protection during plastering</li> </ul>	
	DE22	<p><b>POKROV DOZE DEKORATIVNI SM60</b></p> <ul style="list-style-type: none"> <li>- dekorativni pokrov doze Ø60</li> <li>- ustreza IEC 60670-1</li> <li>- "halogen free"</li> </ul> <p><i>BOX COVER DECORATIVE SM60</i></p> <ul style="list-style-type: none"> <li>- decorative cover for boxes Ø60</li> <li>- in accordance with IEC 60670-1</li> <li>- halogen free</li> </ul>	



navodila za montažo /  
assembly instructions

razdalja med dozami /  
distance between boxes: 71 mm

razdalja med dozami /  
distance between boxes: 91 mm

DE10,11

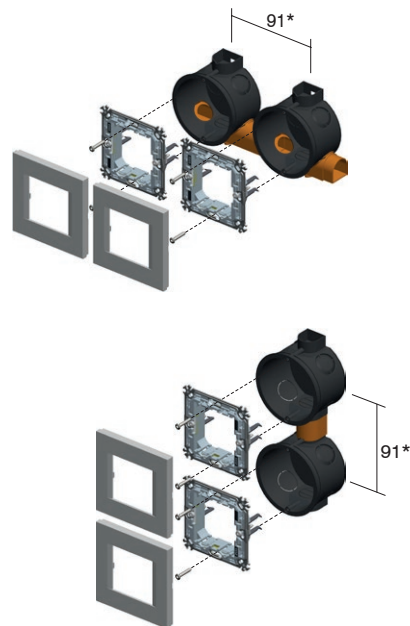
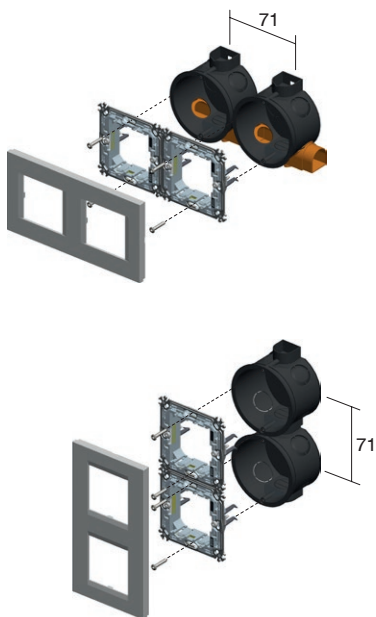
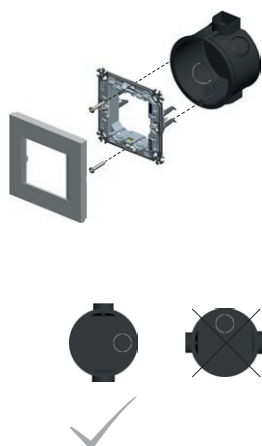

DE12,13

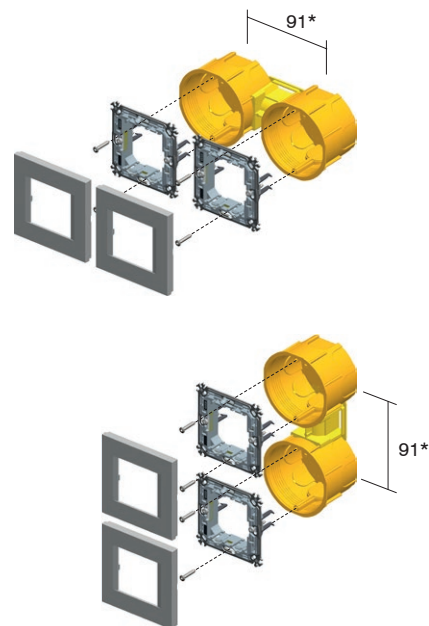
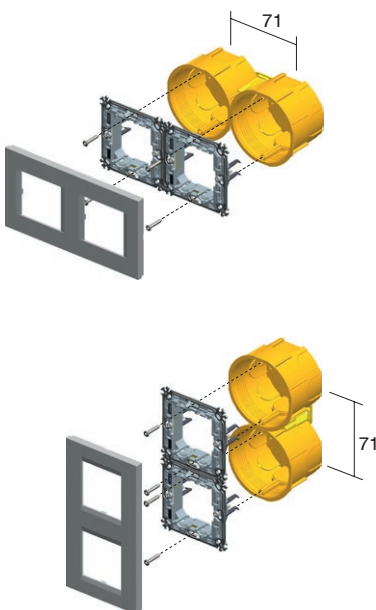
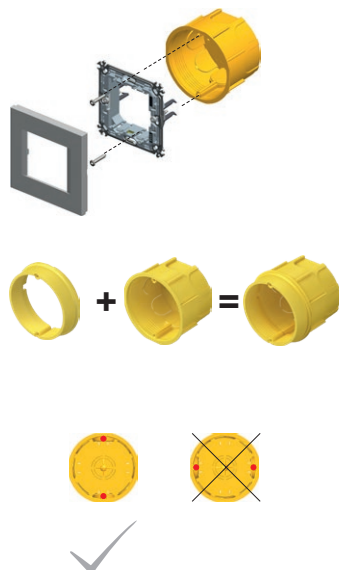

\* za okvirje PURE je minimalna razdalja med dozami 100mm  
\* for PURE cover plates the minimum distance between boxes is 100mm

R O U N D B O X E S



DE10,11



DE12,13



NM20



NM24



DE10,11



DE12,13



NM10



DE10,11



DE12,13



NM23



71

2xDE10,11 + 2xDE31



2xNM20



2xDE12,13 + 1xDE32



2xNM24



2xDE10,11 2xDE12,13 + 1xDE32

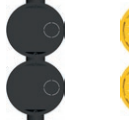

2xNM20



2xNM24

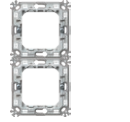

3xDE10,11 + 3xDE31



3xNM20



3xDE12,13 + 2xDE32



3xNM24



3xDE10,11 3xDE12,13 + 2xDE32

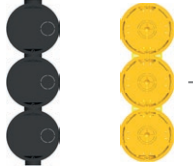

3xNM20



3xNM24



4xDE10,11 + 4xDE31



4xNM20



4xDE12,13 + 3xDE32



4xNM24



4xDE10,11 4xDE12,13 + 3xDE32

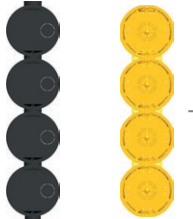

4xNM20



4xNM24

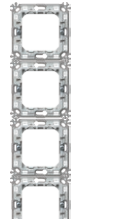





HE10

**DOZA OKROGLA ZA VOTLE STENE SM68x40**

- Ø60, globina 40mm
- vgradnja v izvrtino Ø68
- 850°C, 400V~
- ustreza IEC 60670-1
- montaža s krepeljci
- "halogen free"

*ROUND BOX HOLLOW WALL SM68x40*

- Ø60, depth 40mm
- cutting hole Ø68
- 850°C, 400V~
- in accordance with IEC 60670-1
- mounting with claws
- halogen free

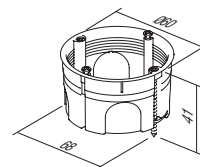

HE11

**DOZA OKROGLA ZA VOTLE STENE SM68x55**

- Ø60, globina 55mm
- vgradnja v izvrtino Ø68
- 850°C, 400V~
- ustreza IEC 60670-1
- montaža s krepeljci
- "halogen free"

*ROUND BOX HOLLOW WALL SM68x55*

- Ø60, depth 55mm
- cutting hole Ø68
- 850°C, 400V~
- in accordance with IEC 60670-1
- mounting with claws
- halogen free

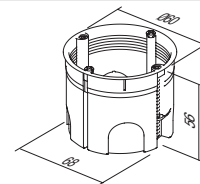

BE10

**DOZA OKROGLA ZA BETON**

- Ø60mm, globina 49mm
- 650°C, 500V~
- ustreza IEC 60670-1
- "halogen free"

*ROUND BOX CONCRETE*

- Ø60mm, depth 49mm
- 650°C, 500V~
- in accordance with IEC 60670-1
- halogen free

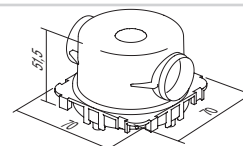

BE11

**DOZA OKROGLA ZA BETON GLOBOKA**

- Ø60mm, globina 58mm
- 650°C, 500V~
- ustreza IEC 60670-1
- "halogen free"

*ROUND BOX CONCRETE DEEP*

- Ø60mm, depth 58mm
- 650°C, 500V~
- in accordance with IEC 60670-1
- halogen free

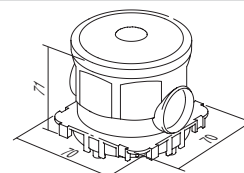

BE20

**NOSILEC DOZE ZA BETON**

- za utrditev doze z distančnim profilom BM82 v nasprotno steno
- ustreza IEC 60670-1
- "halogen free"

*COUNTER BOX SUPPORT CONCRETE*

- to support concrete boxes with discance profile BM82 for extreme loads
- in accordance with IEC 60670-1
- halogen free

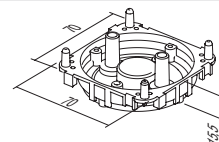

BE21

**UVODNICA DOZE ZA BETON 16**

- za utrditev instalacijske cevi
- ustreza IEC 60670-1
- "halogen free"

*PIPE STOPPER CONCRETE BOX 16*

- for firming installation pipe to box
- in accordance with IEC 60670-1
- halogen free

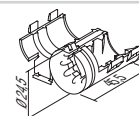

R O U N D      B O X E S

votle stene / hollow walls



beton / concrete



navodila za montažo /  
assembly instructions

razdalja med dozami /  
distance between boxes: 71mm

razdalja med dozami /  
distance between boxes: 91mm

HE10,11

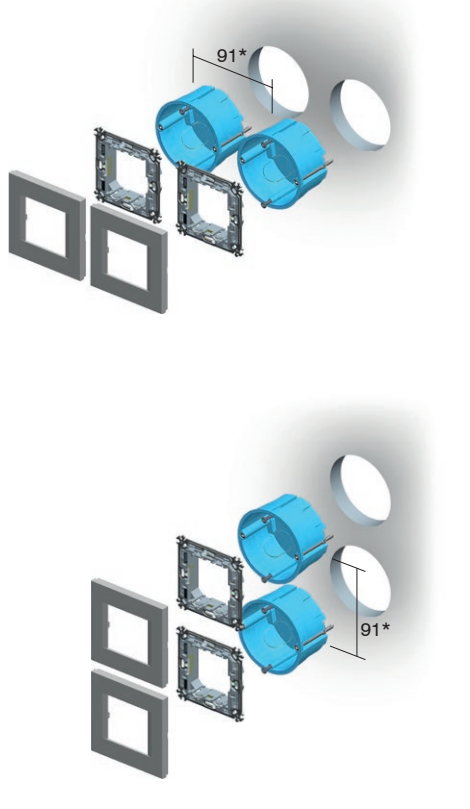
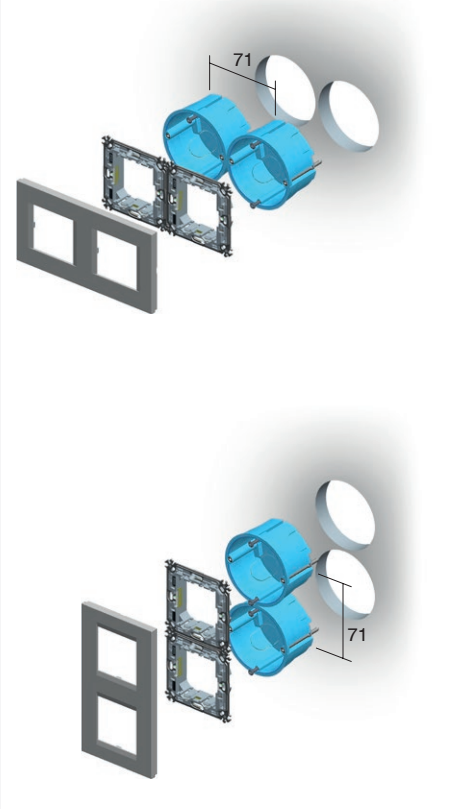
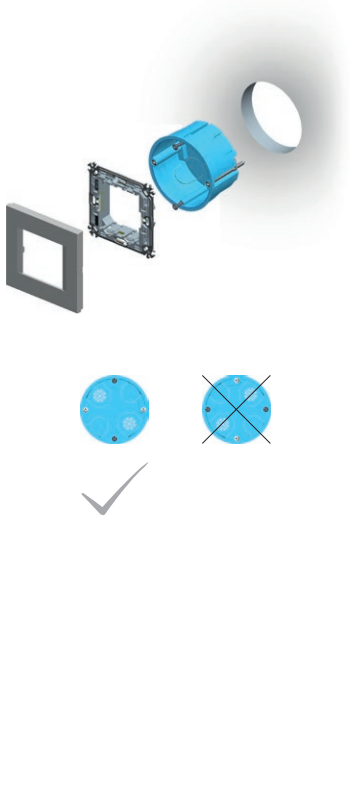

BE10

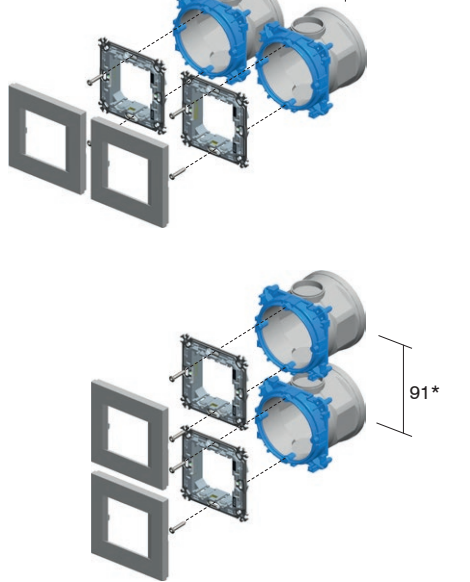
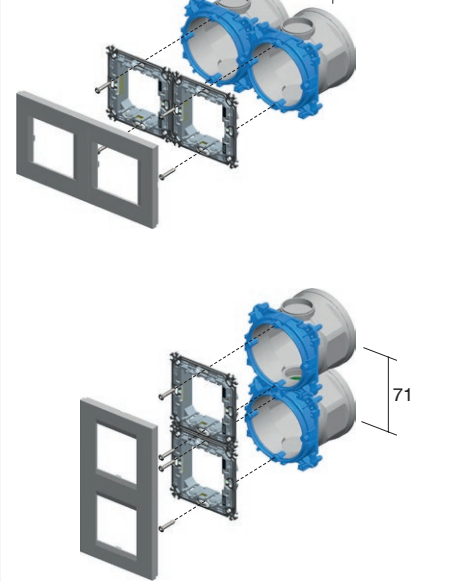
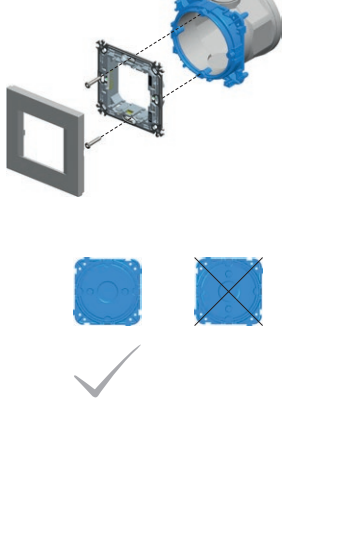

\* za okvirje PURE je min. razdalja me dozami 100mm

\* for PURE cover plates the minimum distance between boxes is 100mm

votle stene / hollow walls



beton / concrete



D O Z E

HE10,11



BE10,11



NM21



NM25



2M

HE10,11



BE10,11



NM11



1/2M

2xHE10,11



2xBE10,11



2xNM21



2xNM25



2x2M

HE10,11



BE10,11



NM32



2/3M

2xHE10,11



2xBE10,11



2xNM21



2xNM25



3xHE10,11



3xBE10,11



3xNM21



3xNM25

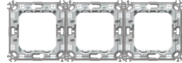

3x2M

3xHE10,11



3xBE10,11



3xNM21



3xNM25

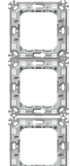

4xHE10,11



4xBE10,11



4xNM21



4xNM25



4x2M

4xHE10,11



4xBE10,11



4xNM21



4xNM25



# R O U N D     B O X E S

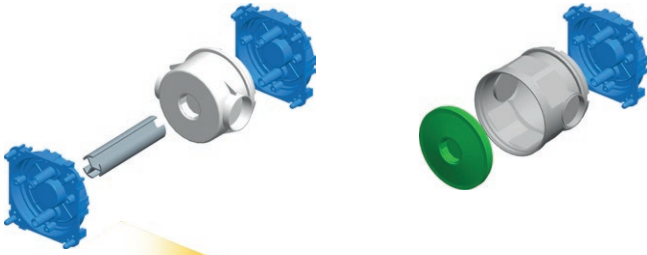

navodila za montažo /  
assembly instructions

1

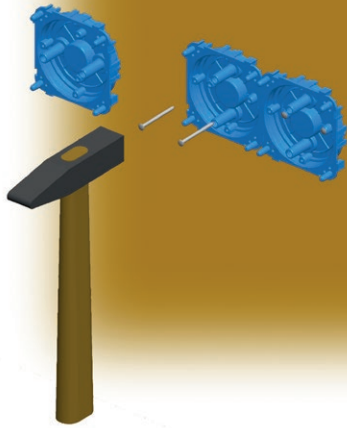

2

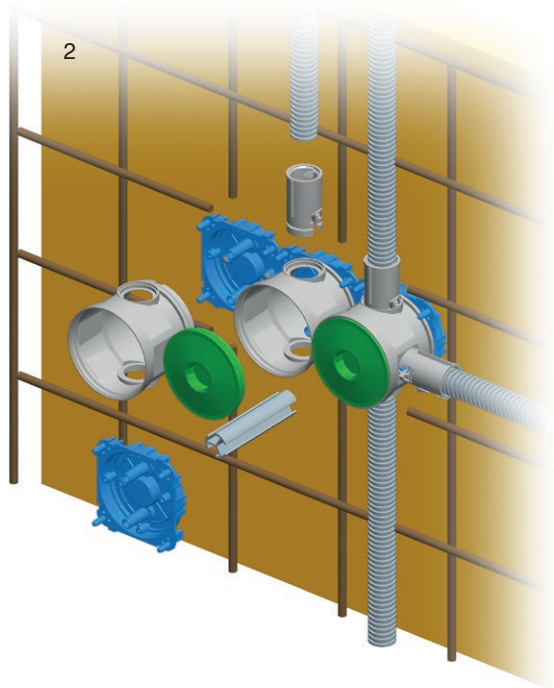

3

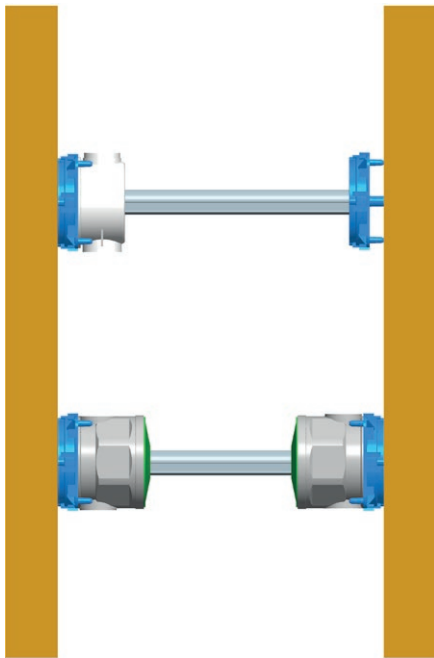

4

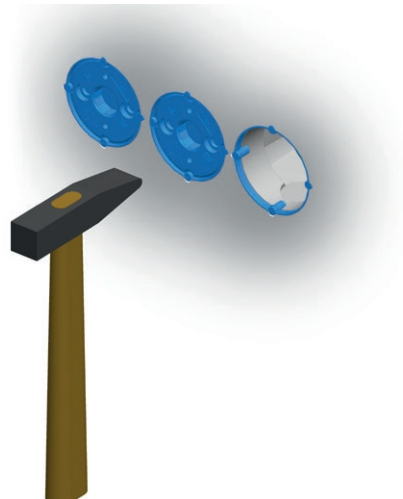





DM30



HM30



BM30

tip type	naziv description	velikost size
DM30	DOZA PRAVOKOTNA ZA ZID RECTANGULAR BOX BRICK	PM3
HM30	DOZA PRAVOKOTNA ZA VOTLE STENE RECTANGULAR BOX HOLLOW WALL	VM3
BM30	DOZA PRAVOKOTNA ZA BETON RECTANGULAR BOX CONCRETE	BM3
·	·	·
·	·	·

DOZA PRAVOKOTNA ZA ZID PM3



DM30

- velikost 3M, globina 49mm
- 650°C, 400V
- ustreza IEC 60670-1
- "halogen free"

RECTANGULAR BOX BRICK PM3

- size 3M, depth 49mm
- 650°C, 400V
- in accordance with IEC 60670-1
- halogen free

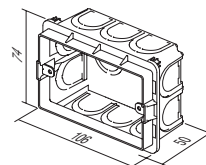

DOZA PRAVOKOTNA ZA ZID PM3-65



DM31

- velikost 3M, globina 65mm
- 650°C, 400V
- ustreza IEC 60670-1
- "halogen free"

RECTANGULAR BOX BRICK PM3-65

- size 3M, depth 65mm
- 650°C, 400V
- in accordance with IEC 60670-1
- halogen free

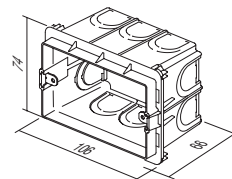

DOZA PRAVOKOTNA ZA ZID PM4



DM40

- velikosti 4M, globina 49mm
- 650°C, 400V
- ustreza IEC 60670-1
- "halogen free"

RECTANGULAR BOX BRICK PM4

- size 4M, depth 49mm
- 650°C, 400V
- in accordance with IEC 60670-1
- halogen free

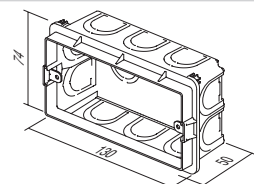

DOZA PRAVOKOTNA ZA ZID PM4-65



DM41

- velikosti 4M, globina 65mm
- 650°C, 400V
- ustreza IEC 60670-1
- "halogen free"

RECTANGULAR BOX BRICK PM4-65

- size 4M, depth 65mm
- 650°C, 400V
- in accordance with IEC 60670-1
- halogen free

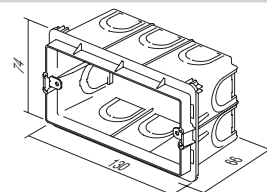

## R E C T A N G U L A R   B O X E S

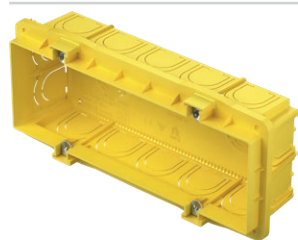

DM70

## DOZA PRAVOKOTNA ZA ZID PM7

- velikost 7M, globina 49mm
- 650°C, 400V $\sim$
- ustreza IEC 60670-1
- "halogen free"

## RECTANGULAR BOX BRICK PM7

- size 7M, depth 49mm
- 650°C, 400V $\sim$
- in accordance with IEC 60670-1
- halogen free

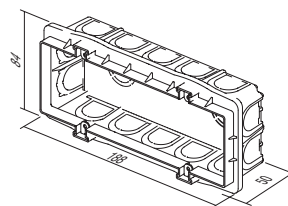

DM71

## DOZA PRAVOKOTNA ZA ZID PM7-65

- velikost 7M, globina 65mm
- 650°C, 400V $\sim$
- ustreza IEC 60670-1
- "halogen free"

## RECTANGULAR BOX BRICK PM7-65

- size 7M, depth 65mm
- 650°C, 400V $\sim$
- in accordance with IEC 60670-1
- halogen free

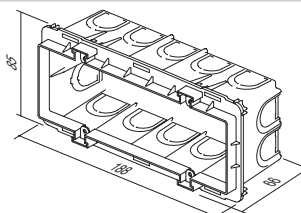

DM72

## DOZA PRAVOKOTNA ZA ZID PM72-65

- velikost 2x7M, globina 64mm
- 650°C, 400V $\sim$
- ustreza IEC 60670-1
- "halogen free"

## RECTANGULAR BOX BRICK PM72-65

- size 2x7M, depth 64mm
- 650°C, 400V $\sim$
- in accordance with IEC 60670-1
- halogen free

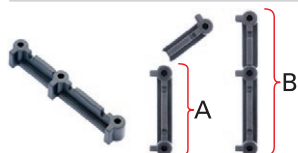
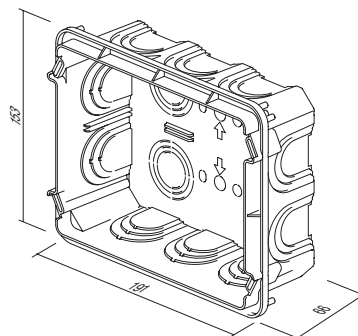

DM80

## VEZNI ČLEN DOZE PM

- za vertikalno (A) in horizontalno (B) sestavo doz PM3, PM4 in PM7
- primeren za dekorativne okvirje Line in Soft (za PURE ni primeren)

## DISTANCE PIECE FOR BOX PM

- for vertical (A) and horizontal (B) fitting of boxes PM3, PM4 and PM7
- suitable for Line and Soft decorative cover plates (not for PURE)

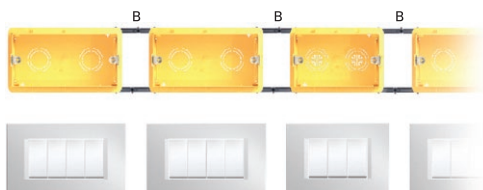
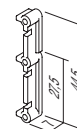



DM33

## POKROV DOZE ZAŠČITNI PM3

- zaščitni pokrov doze PM3
- ustreza IEC 60670-1
- "halogen free"
- za zaščito pri ometavanju

## BOX COVER PROTECTIVE PM3

- protective cover for box PM3
- in accordance with IEC 60670-1
- halogen free
- box protection during plastering

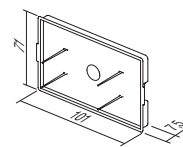

DM34

## POKROV DOZE DEKORATIVNI PM3

- dekorativni pokrov doze 3M
- vijaka priložena
- ustreza IEC 60670-1
- "halogen free"

## BOX COVER DECORATIVE PM3

- decorative cover for boxes 3M
- screws are included
- in accordance with IEC 60670-1
- halogen free

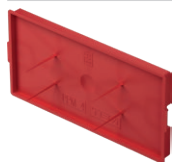
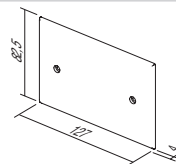

DM43

## POKROV DOZE ZAŠČITNI PM4

- zaščitni pokrov doze PM4
- ustreza IEC 60670-1
- "halogen free"
- za zaščito pri ometavanju

## BOX COVER PROTECTIVE PM4

- protective cover for box PM4
- in accordance with IEC 60670-1
- halogen free
- box protection during plastering

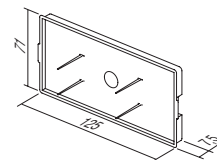

DM44

## POKROV DOZE DEKORATIVNI PM4

- dekorativni pokrov doze 4M
- vijaka priložena
- ustreza IEC 60670-1
- "halogen free"

## BOX COVER DECORATIVE PM4

- decorative cover for boxes 4M
- screws are included
- in accordance with IEC 60670-1
- halogen free

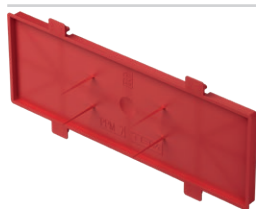
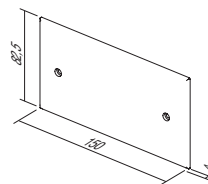

DM73

## POKROV DOZE ZAŠČITNI PM7

- zaščitni pokrov doze PM7
- ustreza IEC 60670-1
- "halogen free"
- za zaščito pri ometavanju

## BOX COVER PROTECTIVE PM7

- protective cover for box PM7
- in accordance with IEC 60670-1
- halogen free
- box protection during plastering

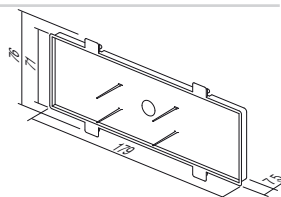

DM74

## POKROV DOZE DEKORATIVNI PM7

- dekorativni pokrov doze 7M
- vijaka priložena
- ustreza IEC 60670-1
- "halogen free"

## BOX COVER DECORATIVE PM7

- decorative cover for boxes 7M
- screws are included
- in accordance with IEC 60670-1
- halogen free

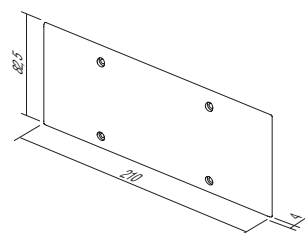

## R E C T A N G U L A R   B O X E S



DM75

## POKROV DOZE DEKORATIVNI PM72

- dekorativni pokrov doze 2x7M
- vijaki priloženi
- ustreza IEC 60670-1

*BOX COVER DECORATIVE PM72*

- decorative cover for boxes 2x7M
- screws are included
- in accordance with IEC 60670-1

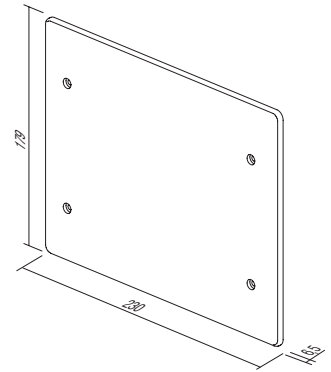





HM30

DOZA PRAVOKOTNA ZA VOTLE STENE VM3

- velikost 3M, globina 49mm
- vgradnja v izvrtino 2xØ68/45mm
- 850°C, 400V<sup>~</sup>
- ustreza IEC 60670-1
- "halogen free"

RECTANGULAR BOX HOLLOW WALL VM3

- size 3M, depth 49mm
- cutting hole 2xØ68/45mm
- 850°C, 400V<sup>~</sup>
- in accordance with IEC 60670-1
- halogen free

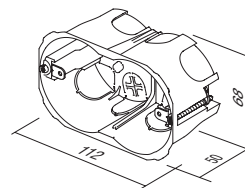

HM40

DOZA PRAVOKOTNA ZA VOTLE STENE VM4

- velikost 4M, globina 49mm
- vgradnja v izvrtino 2xØ68/70mm
- 850°C, 400V<sup>~</sup>
- ustreza IEC 60670-1
- "halogen free"

RECTANGULAR BOX HOLLOW WALL VM4

- size 4M, depth 49mm
- cutting hole 2xØ68/70mm
- 850°C, 400V<sup>~</sup>
- in accordance with IEC 60670-1
- halogen free

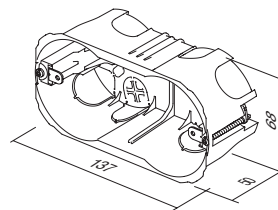

HM70

DOZA PRAVOKOTNA ZA VOTLE STENE VM7

- velikost 7M, globina 49mm
- vgradnja v izvrtino 2xØ68/120mm
- 850°C, 400V<sup>~</sup>
- ustreza IEC 60670-1
- "halogen free"

RECTANGULAR BOX HOLLOW WALL VM7

- size 7M, depth 49mm
- cutting hole 2xØ68/120mm
- 850°C, 400V<sup>~</sup>
- in accordance with IEC 60670-1
- halogen free

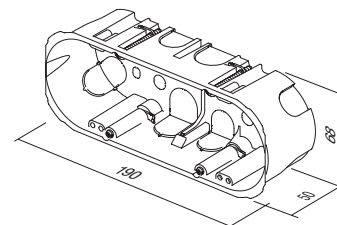

HM72

DOZA PRAVOKOTNA ZA VOTLE STENE VM72

- velikost 2x7M, globina 63mm
- 850°C, 400V<sup>~</sup>
- ustreza IEC 60670-1
- "halogen free"

RECTANGULAR BOX HOLLOW WALL VM72

- size 2x7M, depth 63mm
- 850°C, 400V<sup>~</sup>
- in accordance with IEC 60670-1
- halogen free

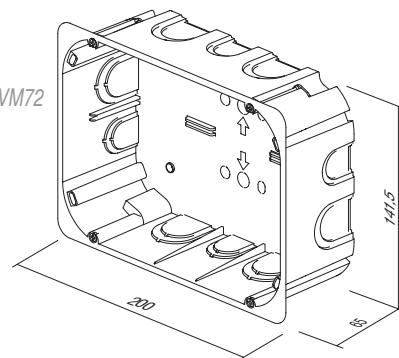

## R E C T A N G U L A R   B O X E S

## DOZA PRAVOKOTNA ZA BETON BM3



BM30

- velikost 3M, globina 60mm
- 650°C, 400V $\sim$
- ustreza IEC 60670-1
- "halogen free"

*RECTANGULAR BOX CONCRETE BM3*

- size 3M, depth 60mm
- 650°C, 400V $\sim$
- in accordance with IEC 60670-1
- halogen free

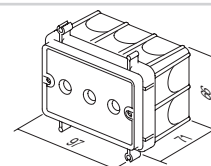

## DOZA PRAVOKOTNA ZA BETON BM4



BM40

- velikost 4M, globina 60mm
- 650°C, 400V $\sim$
- ustreza IEC 60670-1
- "halogen free"

*RECTANGULAR BOX CONCRETE BM4*

- size 4M, depth 60mm
- 650°C, 400V $\sim$
- in accordance with IEC 60670-1
- halogen free

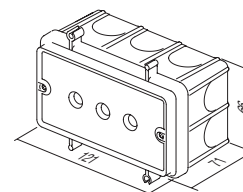

## DOZA PRAVOKOTNA ZA BETON BM7



BM70

- velikost 7M, globina 60mm
- 650°C, 400V $\sim$
- ustreza IEC 60670-1
- "halogen free"

*RECTANGULAR BOX CONCRETE BM7*

- size 7M, depth 60mm
- 650°C, 400V $\sim$
- in accordance with IEC 60670-1
- halogen free

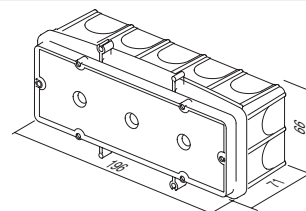

## PRITRDILNI ČLEN DOZ BM



BM80

- za hitro pritrditev pravokotnih doz BM na armaturno mrežo
- primerno za palice do premera Ø8mm

*FIXING COMBI-CLIP BM*

- for fast fixation of BM rectangular boxes on reinforcing bar
- suitable for bar diameter up to Ø8mm

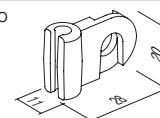

## DISTRANČNI PROFIL ZA DOZE



BM82

- za utrditev doz BM skupaj z nosilcem doze za beton v nasprotno steno
- dolžina l=1m, premer Ø20mm

*DISTANCE PROFIL FOR BOXES BM*

- to support boxes BM with counter box support on opposite wall
- length l=1m, diameter Ø20mm

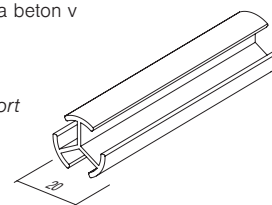

P R A V O K O T N E D O Z E



opeka / brick



votle stene / hollow walls

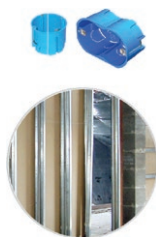

beton / concrete

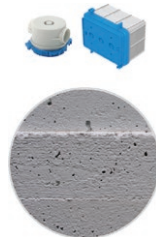



D O Z E

DM30   **NM30**

HM30  

BM30 

**3M**

DM40   **NM40**

HM40  

BM40 

**4M**

DM70   **NM70**

HM70  

BM70 

**7M**

DM72   **NM72**

HM72 

**2x7M**

DM30   **NM32**

HM30  

BM30 

**2/3M**

## R E C T A N G U L A R   B O X E S

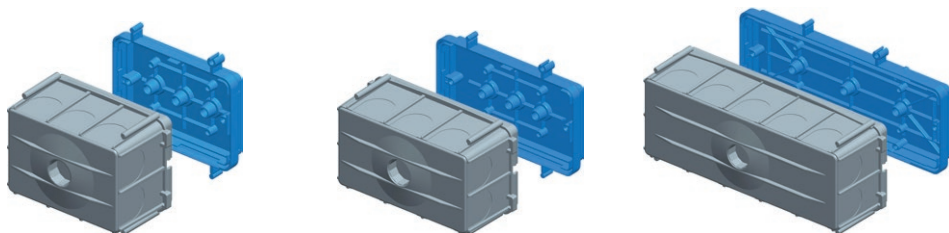

navodila za montažo /  
assembly instructions

1

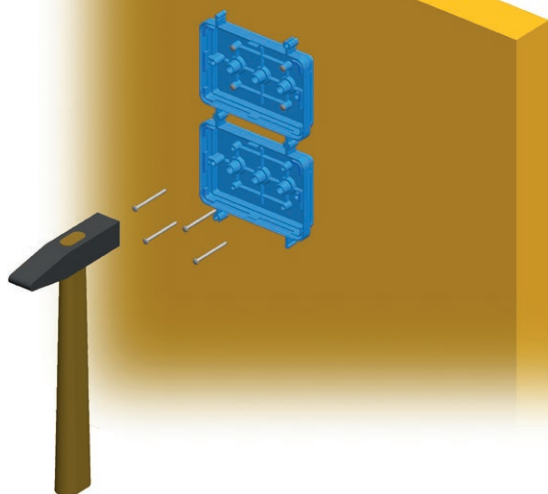

2

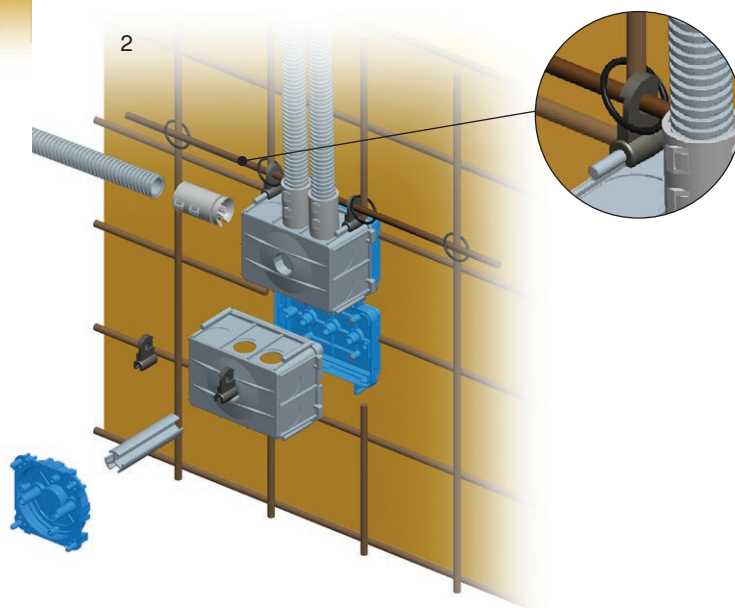

3

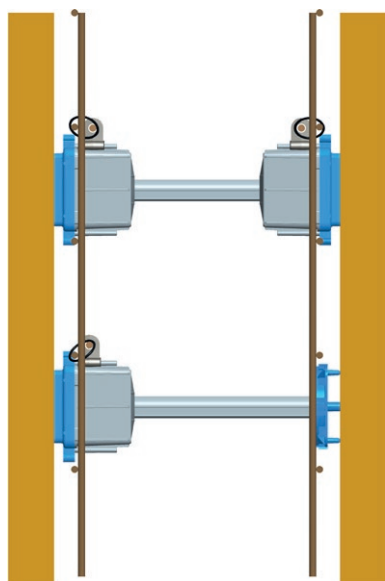

4

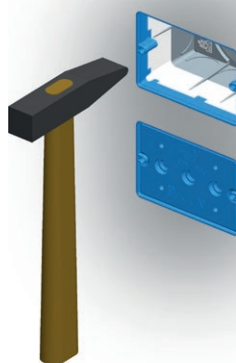





DW10

**RAZVODNA DOZA OKROGLA ZA ZID DSM78**

- Ø78, globina 40mm
- 650°C, 500V<sup>~</sup>
- ustreza IEC 60670-1 in IEC 60670-22
- "halogen free"

*CONNECTION ROUND BOX BRICK DSM78*

- Ø78, depth 40mm
- 650°C, 500V<sup>~</sup>
- in accordance with IEC 60670-1 and IEC 60670-22
- halogen free

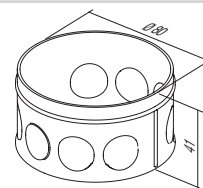

HW10

**RAZVODNA DOZA OKROGLA ZA VOTLE STENE SM78x45**

- Ø78, globina 45mm
- vgradnja v izvrtino Ø80
- 850°C, 400V<sup>~</sup>
- ustreza IEC 60670-1 in IEC 60670-22
- montaža s krepeljci
- "halogen free"

*CONNECTION ROUND BOX HOLLOW WALL SM78x45*

- Ø78, depth 45mm
- cutting hole Ø80
- 850°C, 400V<sup>~</sup>
- in accordance with IEC 60670-1 and IEC 60670-22
- mounting with claws
- halogen free

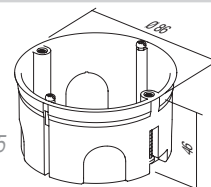

DE23

**POKROV DOZE DEKORATIVNI SM78**

- dekorativni pokrov doze Ø78
- ustreza IEC 60670-1 and IEC 60670-22
- "halogen free"

*BOX COVER DECORATIVE SM78*

- decorative cover for boxes Ø78
- in accordance with IEC 60670-1 and IEC 60670-22
- halogen free

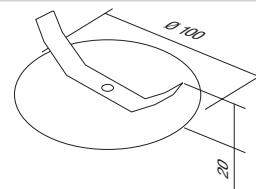

DE24

**POKROV DOZE ZAŠČITNI 78**

- zaščitni pokrov doze Ø78
- ustreza IEC 60670-1 in IEC 60670-22
- "halogen free"

*BOX COVER PROTECTIVE 78*

- protective cover for box Ø78
- in accordance with IEC 60670-1 and IEC 60670-22
- halogen free

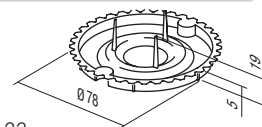

HW20

**RAZVODNA DOZA KVADRATNA ZA ZID SM105x105**

- 105x105mm, globina 50mm
- vgradnja v izvrtino s priloženo šablono
- 850°C, 400V<sup>~</sup>
- ustreza IEC 60670-1 in IEC 60670-22
- montaža s krepeljci
- "halogen free"

*CONNECTION SQUARE BOX BRICK SM105x105*

- size 105x105mm, depth 50mm
- cutting hole according to attached template
- 850°C, 400V<sup>~</sup>
- in accordance with IEC 60670-1 and IEC 60670-22
- mounting with claws
- halogen free

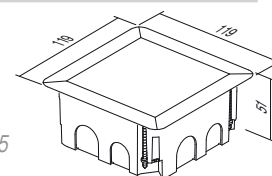

J U N C T I O N   B O X E S

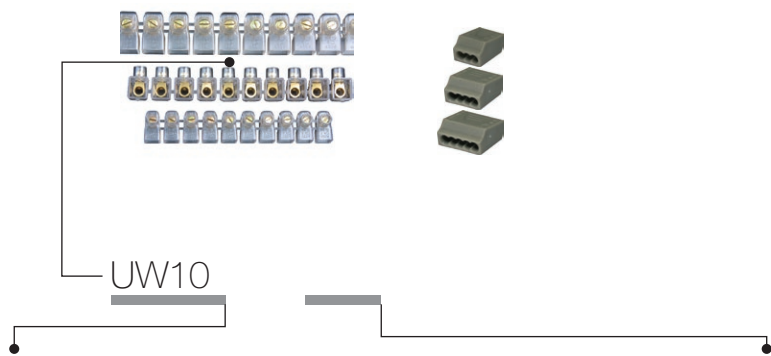

tip type	naziv description	tehnični opis technical data	velikost size	barva colour
UW10	ENOREDNE SPONKE ZAPRTE 1 ROW TERMINAL BLOCKS	2x2.5mm <sup>2</sup>	10P	☑ TS prozorna transparent
UW11	ENOREDNE SPONKE ZAPRTE 1 ROW TERMINAL BLOCKS	2x4mm <sup>2</sup>	10P	☑ CO barvne colour
UW12	ENOREDNE SPONKE ZAPRTE 1 ROW TERMINAL BLOCKS	2x6mm <sup>2</sup>	10P	☐ WH bela white
⋮	⋮	⋮	⋮	☐ GY siva grey

### ENOREDNE SPONKE ZAPRTE



- 450V<sup>~</sup>; 2x2.5mm<sup>2</sup> ÷ 2x6mm<sup>2</sup>
- termoplast PC, prozorne
- število polov: 10

#### 1 ROW TERMINAL BLOCKS CLOSED

- 450V<sup>~</sup>; 2x2.5mm<sup>2</sup> ÷ 2x6mm<sup>2</sup>
- termoplast PC, transparent
- number of poles: 10

UW10TS	(NS12)	2x2.5mm <sup>2</sup>	10P
UW11TS	(NS12)	2x4mm <sup>2</sup>	10P
UW12TS	(NS12)	2x6mm <sup>2</sup>	10P

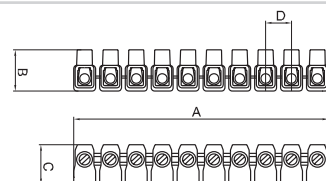

	A	B	C	D
2x2.5 □	110	17.5	17.5	11
2x4 □	128	21	19	12.5
2x6 □	146	21.5	22	15

### ENOREDNE SPONKE

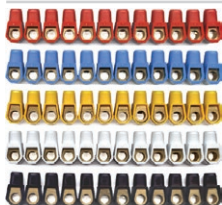

- 450V<sup>~</sup>; 2x2.5mm<sup>2</sup> ÷ 2x6mm<sup>2</sup>
- termoplast PA
- na voljo v različnih barvah
- število polov: 12

#### 1 ROW TERMINAL BLOCKS

- 450V<sup>~</sup>; 2x2.5mm<sup>2</sup> ÷ 2x6mm<sup>2</sup>
- termoplast PA
- available in different colours
- number of poles: 12

UW15CO	(NS12)	2x2.5mm <sup>2</sup>	12P
UW16CO	(NS12)	2x4mm <sup>2</sup>	12P
UW17CO	(NS12)	2x6mm <sup>2</sup>	12P

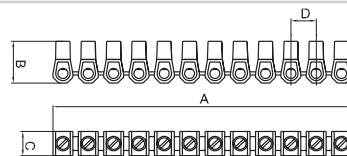

	A	B	C	D
2x2.5 □	110	16.4	9	10
2x4 □	118.8	19	10	10
2x6 □	129.8	21.3	11	11.8

### DVOREDNE SPONKE PP

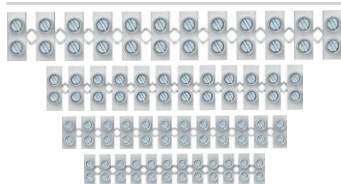

- 450V<sup>~</sup>; 1 mm<sup>2</sup> ÷ 16 mm<sup>2</sup>
- termoplast polipropilen PP, bele
- za uporabo do 80°C
- število polov: 12

#### 2 ROW TERMINAL BLOCKS PP

- 450V<sup>~</sup>; 1mm<sup>2</sup> ÷ 16mm<sup>2</sup>
- thermoplast polypropylene PP, white
- for temperatures up to 80°C
- number of poles: 12

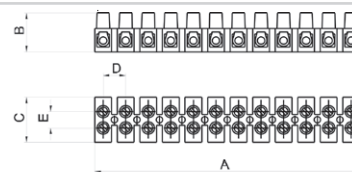

					A	B	C	D	E
UW29WHPP	1.0-4.0mm <sup>2</sup>	24 A	450 V		94,9	13	16,6	8,1	6,4
UW30WHPP	1.5-6.0mm <sup>2</sup>	32 A	450 V		116,5	14,9	18,9	10	7,3
UW31WHPP	2.5-10mm <sup>2</sup>	41 A	450 V		133,8	17,3	23,4	11,5	10
UW32WHPP	4-16mm <sup>2</sup>	76 A	450 V		174,5	20,7	25	15	11

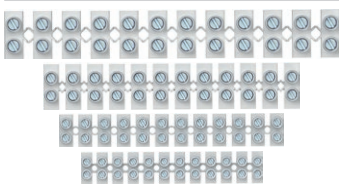
**DVOREDNE SPONKE PA**

- 450 V $\sim$ ; 1 mm<sup>2</sup> ÷ 16 mm<sup>2</sup>
- termoplast poliamid PA, bele
- za uporabo do 110°C
- število polov: 12

**2 ROW TERMINAL BLOCKS PA**

- 450V $\sim$ ; 1mm<sup>2</sup> ÷ 16mm<sup>2</sup>
- thermoplast polyamide PA, white
- for temperatures up to 110°C
- number of poles: 12

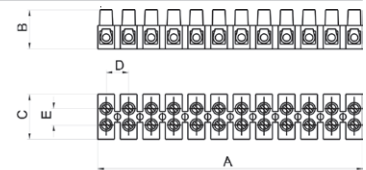

					A	B	C	D	E
UW25WHPA	1.0-4.0mm <sup>2</sup>	24 A	450 V		93,6	13,4	16,2	8	6,4
UW26WHPA	1.5-6.0mm <sup>2</sup>	32 A	450 V		117	15	18,6	10	7,3
UW27WHPA	2.5-10mm <sup>2</sup>	41 A	450 V		132,8	17,3	22,2	11,5	10
UW28WHPA	4-16mm <sup>2</sup>	76 A	450 V		173,9	20,8	25,2	15	11

**BREZVIJAČNE SPONKE**

- 24A 450V $\sim$ , termoplast PA, sive
- število polov: 3÷8
- brezvijačni kontakti 0.5 ÷ 1.5mm<sup>2</sup>, za trde žice
- ustreza EN 60998-1

**PLUG-IN WIRE CONNECTORS**

- 24A 450V $\sim$ , thermoplast PA, grey
- number of poles: 3÷8
- plug-in contacts 0.5÷1.5mm<sup>2</sup>, for rigide wires
- in accordance with EN 60998-1



UW40GY	PC153	1.5mm <sup>2</sup>	3P	3P	A	B	C
UW41GY	PC155	1.5mm <sup>2</sup>	5P	5P	12	18	9
UW42GY	PC158	1.5mm <sup>2</sup>	8P	8P	17	18	9
					26	18	9

**BREZVIJAČNE SPONKE**

- 24A 450V $\sim$ , termoplast PA, sive
- število polov: 3÷5
- brezvijačni kontakti 1.5 ÷ 2.5mm<sup>2</sup>, za trde žice
- ustreza EN 60998-1

**PLUG-IN WIRE CONNECTORS**

- 24A 450V $\sim$ , thermoplast PA, grey
- number of poles: 3÷5
- plug-in contacts 1.5÷2.5mm<sup>2</sup>, for rigide wires
- in accordance with EN 60998-1

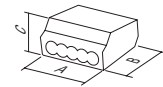

UW45GY	PC253	2.5mm <sup>2</sup>	3P	3P	A	B	C
UW46GY	PC254	2.5mm <sup>2</sup>	4P	4P	14	19	9
UW47GY	PC255	2.5mm <sup>2</sup>	5P	5P	17	19	9
					21	19	9

**BREZVIJAČNE SPONKE**

- 24A 450V $\sim$ , termoplast PA, sive
- število polov: 2 (trda žica)+1 (mehka žica)
- brezvijačni kontakti 1.5 ÷ 2.5mm<sup>2</sup>
- ustreza EN 60998-1

**PLUG-IN WIRE CONNECTOR**

- 24A 450V $\sim$ , thermoplast PA, grey
- number of poles: 2 (rigide wire)+1 (soft wire)
- plug-in contacts 1.5÷2.5mm<sup>2</sup>
- in accordance with EN 60998-1

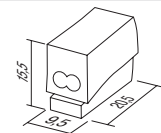

UW50WH	PC302	2.5mm <sup>2</sup>	2/1P				
--------	-------	--------------------	------	--	--	--	--



TEM

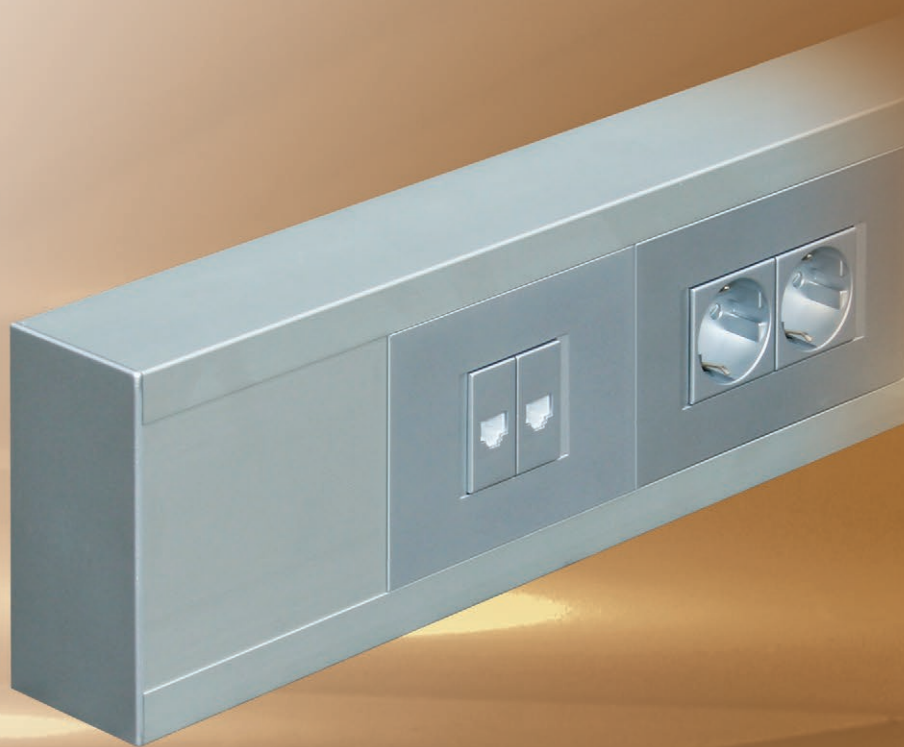



OHIŠJA CUBO IP20 AC  
BOXES CUBO IP20 AC



162

OHIŠJA CUBO IP55 AQ  
BOXES CUBO IP55 AQ



163

PARAPETNI KANALI ALUMINIJSKI MA  
TRUNKING SYSTEM ALUMINIUM MA



165

TALNE DOZE MT  
FLOOR BOXES MT



171

RAZVODNE OMARICE MO  
DISTRIBUTION BOARDS MO



173

# O H I Š J A C U B O I P 2 0 A C

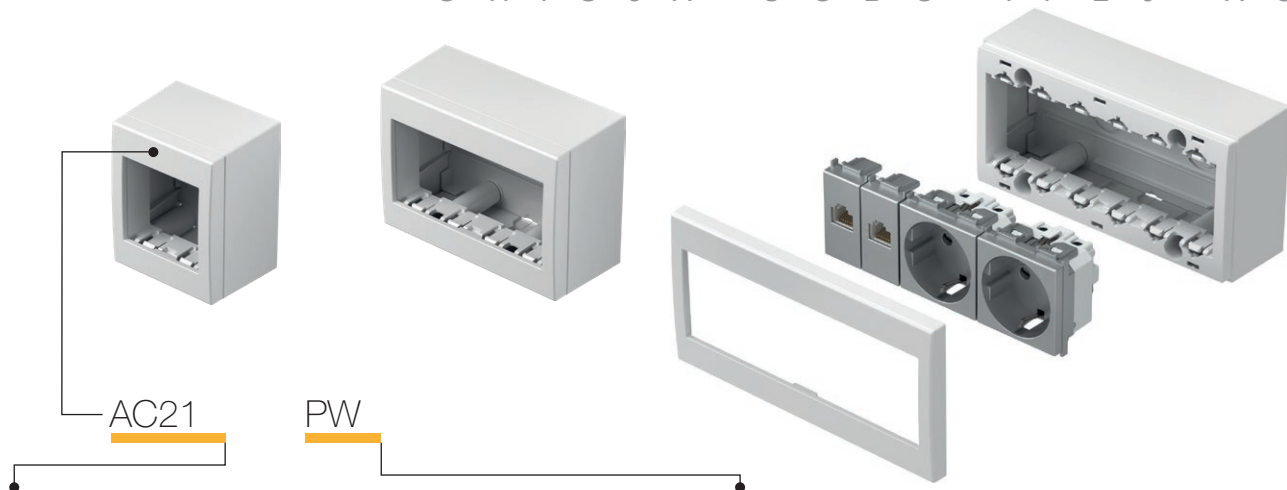

tip type	naziv description	tehnični opis technical data	velikost size	barva colour
AC11	OHIŠJE NO CUBO Z DNOM SURFACE MOUNT BOX WITH BACK SIDE COVER	IP20	1M	<input type="checkbox"/> PW bela-sijaj polar white <input type="checkbox"/> ES srebrna-mat elox silver
AC21	OHIŠJE NO CUBO Z DNOM SURFACE MOUNT BOX WITH BACK SIDE COVER	IP20	2M	<input type="checkbox"/> IW bež-sijaj ivory white
AC41	OHIŠJE NO CUBO Z DNOM SURFACE MOUNT BOX WITH BACK SIDE COVER	IP20	4M	

distribucija

## OHIŠJE NO CUBO Z DNOM IP20 1M



- AC11PW
- AC11ES
- AC11IW

- ohišje IP20 1M  
- za nadometno pritrditev elementov  
- primeren za stikala SM  
- ustreza EN 60669-1

*BOX NO CUBO WITH BACK SIDE COVER IP20 1M*  
- box IP20 1M  
- for surface mounting of elements  
- suitable to SM switches  
- in accordance with EN 60669-1



## OHIŠJE NO CUBO Z DNOM IP20 2M



- AC21PW
- AC21ES
- AC21IW

- ohišje IP20 2M  
- za nadometno pritrditev elementov  
- ustreza EN 60669-1, EN60884-1

*BOX NO CUBO WITH BACK SIDE COVER IP20 2M*  
- box IP20 2M  
- for surface mounting of elements  
- in accordance with EN 60669-1, EN60884-1



## OHIŠJE NO CUBO Z DNOM IP20 4M



- AC41PW
- AC41ES
- AC41IW

- ohišje IP20 4M  
- za nadometno pritrditev elementov  
- ustreza EN 60669-1, EN60884-1

*BOX NO CUBO WITH BACK SIDE COVER IP20 4M*  
- box IP20 4M  
- for surface mounting of elements  
- in accordance with EN 60669-1, EN60884-1



## OHIŠJE NO CUBO Z DNOM IP20 6M



- AC61PW
- AC61ES
- AC61IW

- ohišje IP20 6M  
- za nadometno pritrditev elementov  
- ustreza EN 60669-1, EN60884-1

*BOX NO CUBO WITH BACK SIDE COVER IP20 6M*  
- box IP20 6M  
- for surface mounting of elements  
- in accordance with EN 60669-1, EN60884-1

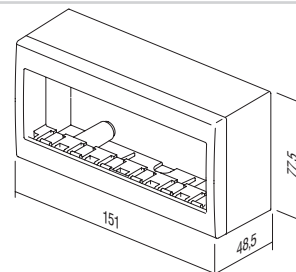
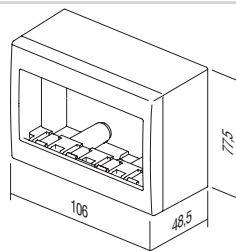
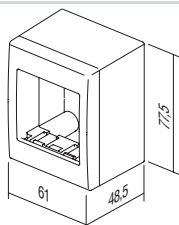
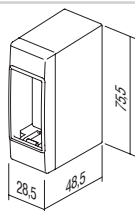

## B O X E S C U B O I P 5 5 A Q

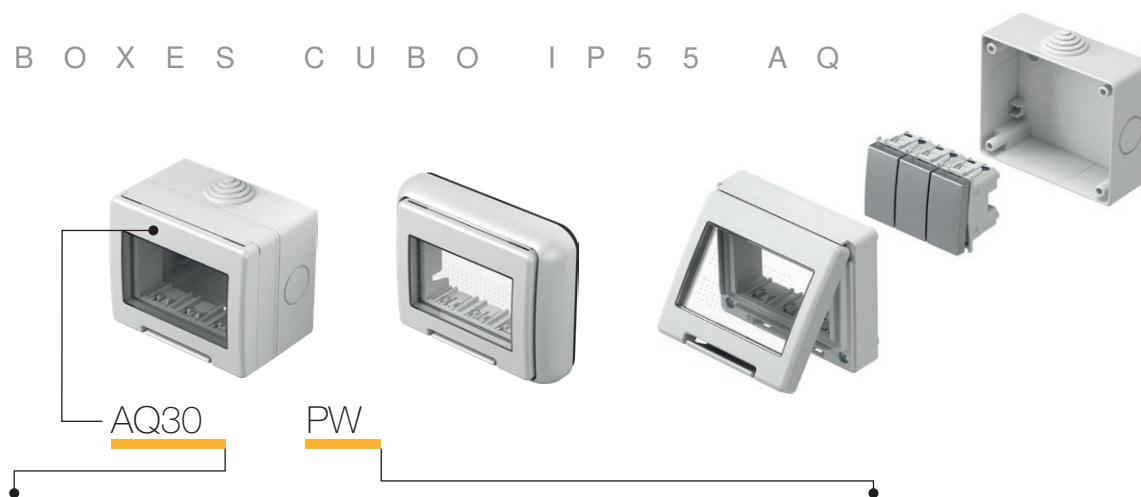

AQ30

PW

tip type	naziv description	tehnični opis technical data	velikost size	barva colour
AQ20	OHIŠJE NO CUBO OUTDOOR SURFACE MOUNT BOX	IP55	2M	<input type="checkbox"/> PW bela sijaj polar white
AQ22	OHIŠJE NO CUBO OUTDOOR SURFACE MOUNT BOX	IP55	2x2M	<input checked="" type="checkbox"/> GY siva grey
AQ30	OHIŠJE NO CUBO OUTDOOR SURFACE MOUNT BOX	IP55	3M	
AQ31	OHIŠJE NO CUBO OUTDOOR SURFACE MOUNT BOX	IP55	3M	

## OHIŠJE NO CUBO IP55 2M



- AQ20PW  
 AQ20GY

- ohišje IP55 2M  
- za nadometno pritrditev  
- IP55 za vgradnjo v vlažne prostore  
- ustreza CEI 23-48, EN 60670

## BOX NO CUBO IP55 2M

- box IP55 2M  
- for surface mounting  
- IP55 for usage in humid areas  
- in accordance with CEI 23-48, EN 60670



## OHIŠJE NO CUBO IP55 2x2M



- AQ22PW  
 AQ22GY

- ohišje IP55 2x2M  
- za nadometno pritrditev  
- IP55 za vgradnjo v vlažne prostore  
- ustreza CEI 23-48, EN 60670

## BOX NO CUBO IP55 2x2M

- box IP55 2x2M  
- for surface mounting  
- IP55 for usage in humid areas  
- in accordance with CEI 23-48, EN 60670



## OHIŠJE NO CUBO IP55 3M



- AQ30PW  
 AQ30GY

- ohišje IP55 3M  
- za nadometno pritrditev  
- IP55 za vgradnjo v vlažne prostore  
- ustreza CEI 23-48, EN 60670

## BOX NO CUBO IP55 3M

- box IP55 3M  
- for surface mounting  
- IP55 for usage in humid areas  
- in accordance with CEI 23-48, EN 60670



## OHIŠJE PO CUBO IP55 3M



- AQ31PW  
 AQ31GY

- ohišje IP55 3M  
- za podometno pritrditev  
- IP55 za vgradnjo v vlažne prostore  
- ustreza CEI 23-48, EN 60670

## BOX PO CUBO IP55 3M

- box IP55 3M  
- for flush mounting  
- IP55 for usage in humid areas  
- in accordance with CEI 23-48, EN 60670







□ AQ21PW

OHIŠJE PO CUBO IP55 2M

- ohišje IP55 2M
- lahko se kombinira z vsemi funkcijskimi elementi Modul
- za podometno pritrditev
- IP55 za vgradnjo v vlažne prostore
- ustreza CEI 23-48, EN 60670

BOX PO CUBO IP55 2M

- box IP55 2M
- can be combined with all Modul functional elements
- for flush mounting
- IP55 for usage in humid areas
- in accordance with CEI 23-48, EN 60670



distribucija

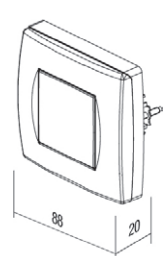
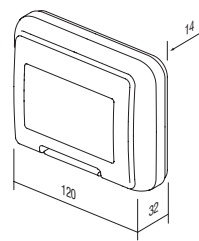
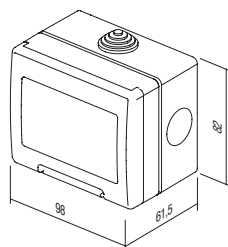
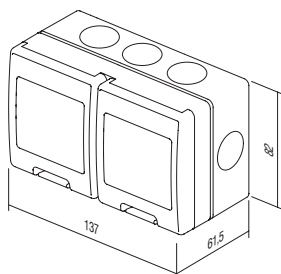
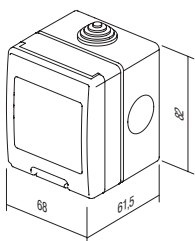

## TRUNKING SYSTEM ALUMINIUM

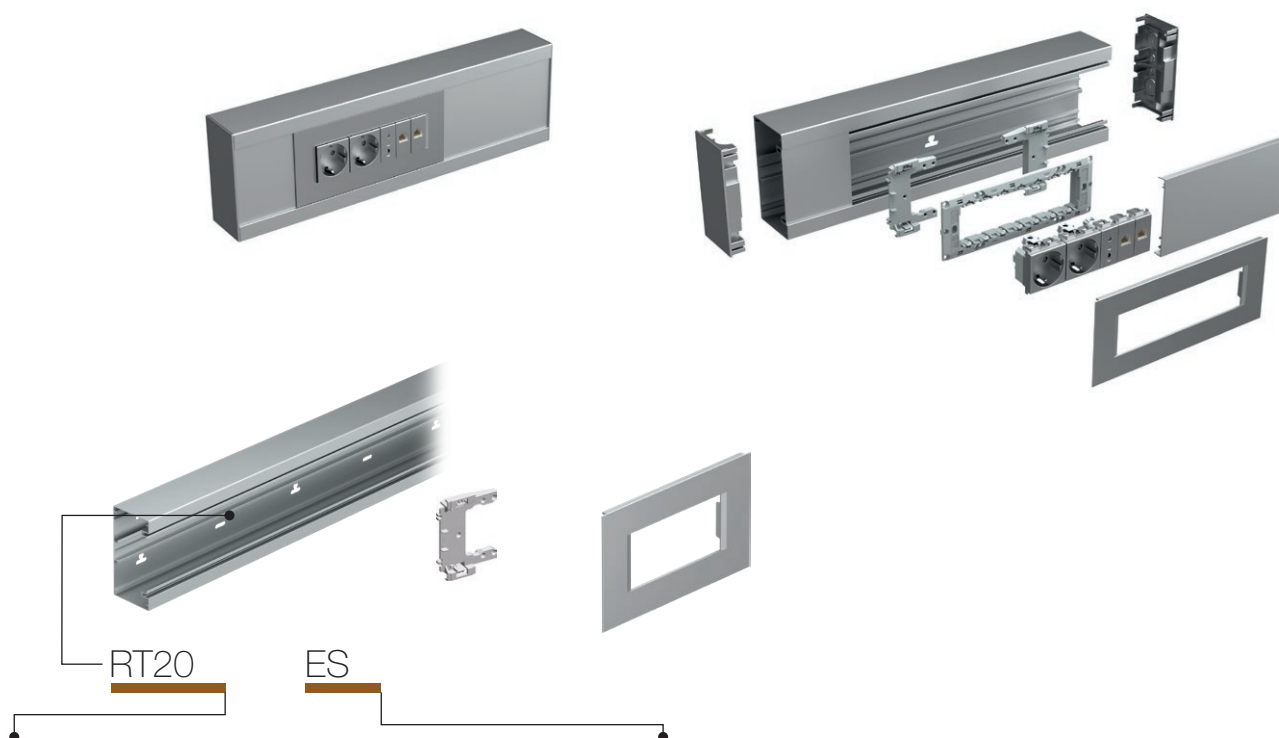

tip type	naziv description	velikost size	barva colour
RT10	ADAPTER MA 92 ADAPTER MA 92	/	■ ES srebna-mat elox silver-mat
RT12	OKVIR MA 92 COVER PLATE MA 92	2/3M	□ PW bela-mat (RAL 9016) white-mat
RT14	OKVIR MA 92 COVER PLATE MA 92	4M	
⋮	⋮	⋮	

## ADAPTER MA 92



RT10

- adapter za pritrditev nosilcev 2/3M, 4M ali 7M Modul na kanal MA brez doze
- vsak nosilec potrebuje dva adapterja
- ustreza EN 50085-1

## ADAPTER MA 92

- adapter for fixing mounting frames 2/3M, 4M or 7M on MA trunking without box
- each mounting frame needs two adapters
- in accordance with EN 50085-1



## OKVIR MA 92 2/3M



■ RT12ES  
□ RT12PW

- dekorativni okvir MA 2/3M
- ustreza EN 50085-1

## COVER PLATE MA 92 2/3M

- decorative cover plate MA 2/3M
- in accordance with EN 50085-1

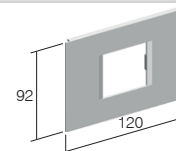

## OKVIR MA 92 4M



■ RT14ES  
□ RT14PW

- dekorativni okvir MA 4M
- ustreza EN 50085-1

## COVER PLATE MA 92 4M

- decorative cover plate MA 4M
- in accordance with EN 50085-1

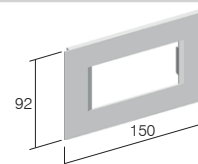

## OKVIR MA 92 7M



■ RT17ES  
□ RT17PW

- dekorativni okvir MA 7M
- ustreza EN 50085-1

## COVER PLATE MA 92 7M

- decorative cover plate MA 7M
- in accordance with EN 50085-1

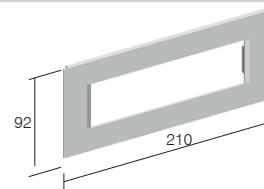



- RT20ES
- RT20PW

#### OSNOVA KANALA MA 130x65

- osnova kanala iz ekstrudiranega aluminija
- višina 130mm, dolžina 2m
- DIN letev 35mm na dnu
- ustreza EN 50085-1

#### TRUNKING BASE MA 130x65

- trunking base from extruded aluminium
- height 130mm, length 2m
- DIN - rail 35mm shape on bottom
- in accordance with EN 50085-1

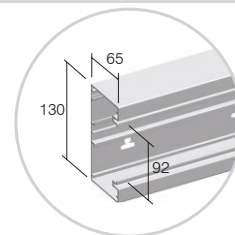

- RT21ES
- RT21PW

#### OSNOVA KANALA MA 165x65

- osnova kanala iz ekstrudiranega aluminija
- višina 165mm, dolžina 2m
- DIN letev 35mm na dnu
- ustreza EN 50085-1

#### TRUNKING BASE MA 165x65

- trunking base from extruded aluminium
- height 165mm, length 2m
- DIN - rail 35mm shape on bottom
- in accordance with EN 50085-1

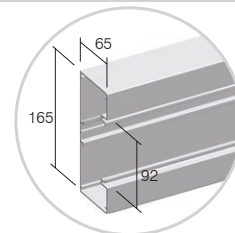

- RT25ES
- RT25PW

#### POKROV KANALA MA 92

- pokrov kanala iz ekstrudiranega aluminija
- višina 92mm, dolžina 2m
- ustreza EN 50085-1

#### FRONT COVER MA 92

- front cover from extruded aluminium
- height 92mm, length 2m
- in accordance with EN 50085-1

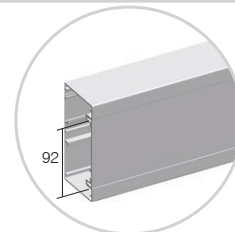

RT30

#### PREGRADA MA 43

- pregrada kanala iz ekstrudiranega polimera
- globina 43mm, dolžina 2m
- ustreza EN 50085-1

#### CABLE SHELF MA 43

- cable shelf from extruded polymer
- depth 43mm, length 2m
- in accordance with EN 50085-1

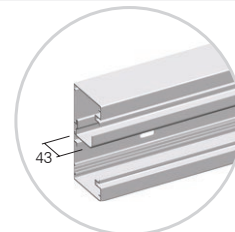

RT31

#### PREGRADA MA 43 AL

- pregrada kanala iz ekstrudiranega aluminija
- globina 43mm, dolžina 2m
- ustreza EN 50085-1

#### CABLE SHELF MA 43 AL

- cable shelf from extruded aluminium
- depth 43mm, length 2m
- in accordance with EN 50085-1

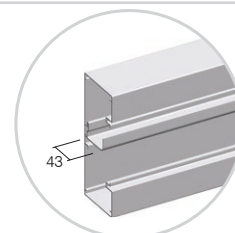

RT32









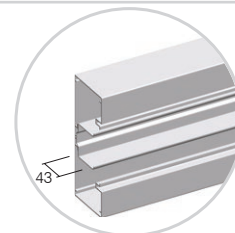

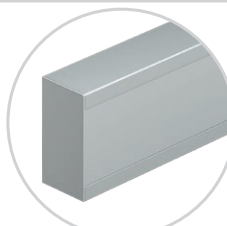
#### PREGRADA MA 43 AL DVOJNA

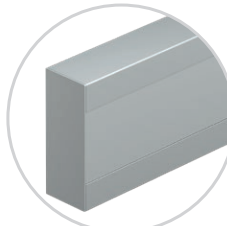
- dvojna pregrada kanala iz ekstrudiranega aluminija
- globina 43mm, dolžina 2m
- ustreza EN 50085-1

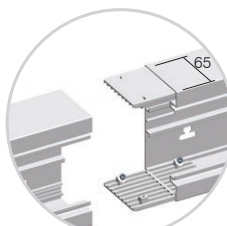
#### CABLE SHELF MA 43 AL DOUBLE

- double cable shelf from extruded aluminium
- depth 43mm, length 2m
- in accordance with EN 50085-1

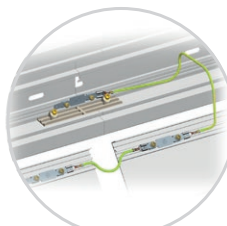

	<ul style="list-style-type: none"> <li>■ RT35ES</li> <li>□ RT35PW</li> </ul>	<p><b>KONČNI ELEMENT MA 130x65</b></p> <ul style="list-style-type: none"> <li>- končni element iz polimera</li> <li>- višina 130mm</li> <li>- ustreza EN 50085-1</li> </ul> <p><i>STOP END MA 130x65</i></p> <ul style="list-style-type: none"> <li>- stop end element from polymer</li> <li>- height 130mm</li> <li>- in accordance with EN 50085-1</li> </ul>	
	<ul style="list-style-type: none"> <li>■ RT36ES</li> <li>□ RT36PW</li> </ul>	<p><b>KONČNI ELEMENT MA 165x65</b></p> <ul style="list-style-type: none"> <li>- končni element iz kovine</li> <li>- višina 165mm</li> <li>- ustreza EN 50085-1</li> </ul> <p><i>STOP END MA 165x65</i></p> <ul style="list-style-type: none"> <li>- stop end element from metal</li> <li>- height 165mm</li> <li>- in accordance with EN 50085-1</li> </ul>	
	RT38	<p><b>SET RAVNI VEZNI ELEMENT MA 65</b></p> <ul style="list-style-type: none"> <li>- vezni element iz polimera</li> <li>- set vsebuje 2 vezna elementa in vijake</li> <li>- ustreza EN 50085-1</li> </ul> <p><i>SET JOINING PIECE MA 65</i></p> <ul style="list-style-type: none"> <li>- joining piece from polymer</li> <li>- set contains two pieces and screws</li> <li>- in accordance with EN 50085-1</li> </ul>	
	<ul style="list-style-type: none"> <li>■ RT40ES</li> <li>□ RT40PW</li> </ul>	<p><b>UNIVERZALNI KOT MA 130x65</b></p> <ul style="list-style-type: none"> <li>- univerzalni kotni element</li> <li>- višina 130mm</li> <li>- ustreza EN 50085-1</li> </ul> <p><i>UNIVERSAL CORNER MA 130x65</i></p> <ul style="list-style-type: none"> <li>- universal corner element</li> <li>- height 130mm</li> <li>- in accordance with EN 50085-1</li> </ul>	
	<ul style="list-style-type: none"> <li>■ RT41ES</li> <li>□ RT41PW</li> </ul>	<p><b>UNIVERZALNI KOT MA 165x65</b></p> <ul style="list-style-type: none"> <li>- univerzalni kotni element</li> <li>- višina 165mm</li> <li>- ustreza EN 50085-1</li> </ul> <p><i>UNIVERSAL CORNER MA 165x65</i></p> <ul style="list-style-type: none"> <li>- universal corner element</li> <li>- height 165mm</li> <li>- in accordance with EN 50085-1</li> </ul>	
	RT42	<p><b>OZEMLJITVENA SPONKA MA 2x A6.3</b></p> <ul style="list-style-type: none"> <li>- ozemljitvena sponka za ozemljitev osnove in pokrova kanala</li> <li>- ustreza EN 50085-1</li> </ul> <p><i>EARTHING PIECE MA 2x A6.3</i></p> <ul style="list-style-type: none"> <li>- earthing piece for earthing of trunking base and front cover</li> <li>- in accordance with EN 50085-1</li> </ul>	



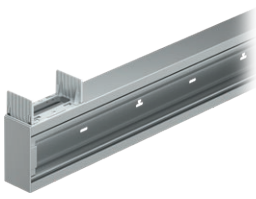

- RT43ES
- RT43PW

L KOTNI ELEMENT MA 130x65

- univerzalni L kotni element iz aluminija
- višina 130mm, dolžina 400mm
- ustreza EN 50085-1

L-BEND MA 130x65

- universal L bend element from aluminium
- height 130mm, length 400mm
- in accordance with EN 50085-1

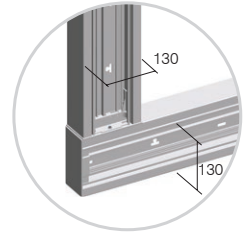

- RT44ES
- RT44PW

L KOTNI ELEMENT MA 165x65

- univerzalni L kotni element iz aluminija
- višina 165mm, dolžina 400mm
- vezava na MA 130x65
- ustreza EN 50085-1

L-BEND MA 165x65

- universal L bend element from aluminium
- height 165mm, length 400mm
- connection on MA 130x65
- in accordance with EN 50085-1

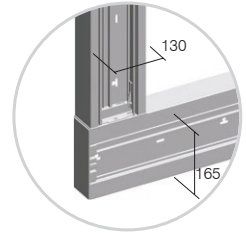

- RT45ES
- RT45PW

T ELEMENT MA 130x65

- univerzalni T kotni element iz aluminija
- višina 130mm, dolžina 400mm
- ustreza EN 50085-1

T-BEND MA 130x65

- universal T bend element from aluminium
- height 130mm, length 400mm
- in accordance with EN 50085-1

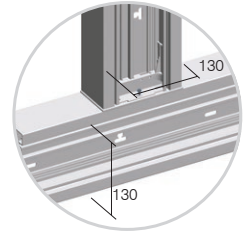

- RT46ES
- RT46PW

T ELEMENT MA 165x65

- univerzalni T kotni element iz aluminija
- višina 165mm, dolžina 400mm
- vezava na MA 130x65
- ustreza EN 50085-1

T-BEND MA 165x65

- universal T bend element from aluminium
- height 165mm, length 400mm
- connection on MA 130x65
- in accordance with EN 50085-1

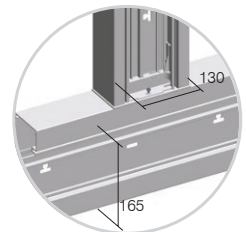

MA je modularni sistem za velikosti: 2M, 4M, 7M

MA trunking is based on modular system making 2M, 4M or 7M combinations of elements

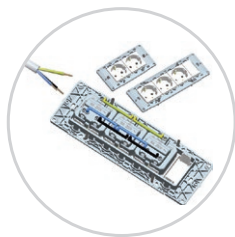

Modul vsebuje tudi elemente pripravljene za hitro montažo

In Modul we provide special elements for quick installation

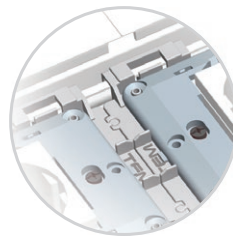

Adapter MA omogoča natančno pozicioniranje na rob kanala

With Adapter MA exact positioning without extra effort is provided

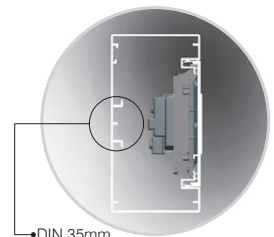

Montaža brez doze pomeni več prostora za kable, DIN letev oblika EN-60715

Mounted without box means more space for cables, DIN-rail base shape EN-60715

# T R U N K I N G   S Y S T E M   A L U M I N I U M



## NOSILEC STEBRIČKA MA ENOJNI 130x65



- RT50ES
- RT50PW

- nosilec za pritržitev kanala MA130 v tla in/ali v strop prostora  
- ustreza EN 50085-1

### FIXING PLATE MA SINGLE 130x65

- fixing plate for fixing trunking base MA130 on the floor and/or on the ceiling  
- in accordance with EN 50085-1



- RT51ES
- RT51PW

## NOSILEC STEBRIČKA MA DVOJNI 130x65

- nosilec za pritržitev dveh kanalov MA130 v tla in/ali v strop prostora  
- ustreza EN 50085-1

### FIXING PLATE MA DOUBLE 130x65

- fixing plate for fixing two trunking bases MA130 on the floor and/or on the ceiling  
- in accordance with EN 50085-1



- RT52ES
- RT52PW

## STEBRIČEK MA 130x65x500

- instalacijski stebriček MA  
- višina 500mm  
- nosilec 7M vgrajen  
- ustreza EN 50085-1

### SERVICE POST MA 130x65x500

- service post MA  
- height 500mm  
- mounting frame 7M included  
- in accordance with EN 50085-1



## STEBRIČEK MA DVOJNI 130x130x500

- RT53ES
- RT53PW

- instalacijski stebriček MA dvojni  
- višina 500mm  
- nosilca 7M vgrajena  
- ustreza EN 50085-1

### SERVICE POST MA DOUBLE 130x130x500

- service post MA double  
- height 500mm  
- mounting frames 7M included  
- in accordance with EN 50085-1

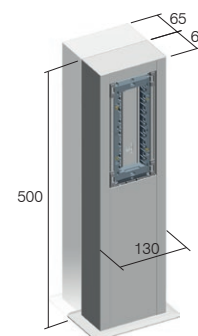

Presek vodnika / Cable intersection mm <sup>2</sup>	Uporabni presek kablov / Cable cross-section (mm <sup>2</sup> )				
	1 vodnik / 1 wire	2 vodnika / 2 wires	3 vodniki / 3 wires	4 vodniki / 4 wires	5 vodnikov / 5 wires
1,5	44	111	121	144	169
2,5	49	133	157	169	211
4	58	169	183	211	256
6	68	196	225	256	307

Kapaciteta kanala / Trunk capacity				
kanal / Trunk	MA 130x65 prazen / empty	MA 130x65 z Modul opremo / with Modul switches and sockets	MA 165x65 prazen / empty	MA 130x65 z Modul opremo / with Modul switches and sockets
kapaciteta capacity max ø	7600 mm <sup>2</sup> 54 mm	5500 mm <sup>2</sup> 2x42 mm	9900 mm <sup>2</sup> 54 mm	7800 mm <sup>2</sup> 2x42 mm



RB33

distribucija

tip type	naziv description	tehnični opis technical data
RB30	TALNA DOZA FLOOR BOX	MT 7
RB31	PODSTAVEK TALNE DOZE FLOOR BOX FLANGE	MT 7
RB33	TALNA DOZA FLOOR BOX	MT 14
⋮	⋮	⋮

	RB30	RB33	RB36	RB40	RB43	RB46
a	170	260	350	170	260	350
b	260	260	260	260	260	260
X	140	230	320	140	230	320
Y	230	230	230	230	230	230

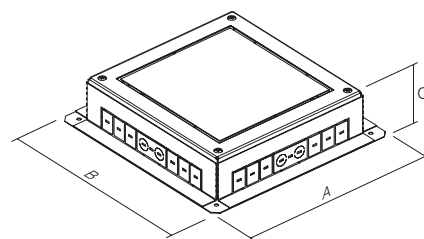
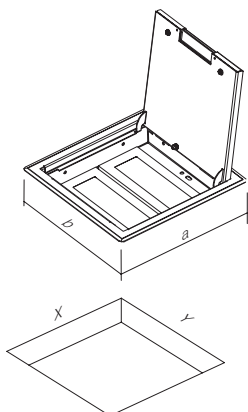

	RB31	RB34	RB37	RB41	RB44	RB47
A	250	340	430	250	340	430
B	340	340	340	340	340	340
C	95-125	95-125	95-125	125-150	125-150	125-150



RB30

**TALNA DOZA MT 7**

- talna doza MT 7
- kovinska, barva srebrna RAL 9006
- nosilec MODUL 7M vgrajen
- vgradna mera 140x230mm, globina min 95mm
- debelina talne obloge pokrova do 10mm
- ustreza EN 50085-1 in EN 50085-2-2

*FLOOR BOX MT 7*

- floor box MT 7
- metal, colour silver RAL 9006
- mounting frame MODUL 7M included
- mounting dimensions 140x230mm, depth min 95mm
- floor lining thickness up to 10mm
- in accordance with EN 50085-1 and EN 50085-2-2



RB40

**TALNA DOZA MT 7 H=88mm**

- talna doza MT 7
- kovinska, barva srebrna RAL 9006
- nosilec MODUL 7M vgrajen
- vgradna mera 140x230mm, globina min 120mm
- debelina talne obloge pokrova do 10mm
- ustreza EN 50085-1 in EN 50085-2-2

*FLOOR BOX MT 7 H=88mm*

- floor box MT 7
- metal, colour silver RAL 9006
- mounting frame MODUL 7M included
- mounting dimensions 140x230mm, depth min 120mm
- floor lining thickness up to 10mm
- in accordance with EN 50085-1 and EN 50085-2-2

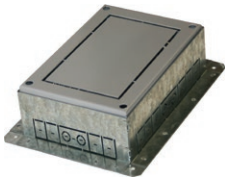

RB31

**PODSTAVEK TALNE DOZE MT 7**

- podstavek talne doze za pokrov MT 7
- kovinski, cinkan
- za vgradnjo v tlak ali dvojni pod
- nastavljiva višina 95-125mm
- ustreza EN 50085-1 in EN 50085-2-2

*FLOOR BOX FLANGE MT 7*

- floor box flange for box cover MT 7
- metal, galvanized
- for installation in a floor or double floor
- adjustable height 95-125mm
- in accordance with EN 50085-1 and EN 50085-2-2

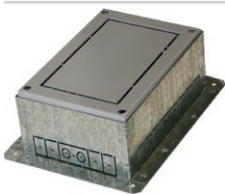

RB41

**PODSTAVEK TALNE DOZE MT 7 H=88mm**

- podstavek talne doze za pokrov MT 7 H=88mm
- kovinski, cinkan
- za vgradnjo v tlak ali dvojni pod
- nastavljiva višina 125-150mm
- ustreza EN 50085-1 in EN 50085-2-2

*FLOOR BOX FLANGE MT 7 H=88mm*

- floor box flange for box cover MT 7 H=88mm
- metal, galvanized
- for installation in a floor or double floor
- adjustable height 125-150mm
- in accordance with EN 50085-1 and EN 50085-2-2



RB33

**TALNA DOZA MT 14**

- talna doza MT 14
- kovinska, barva srebrna RAL 9006
- nosilca MODUL 2x7M vgrajena
- vgradna mera 230x230mm, globina min 95mm
- debelina talne obloge pokrova do 10mm
- ustreza EN 50085-1 in EN 50085-2-2

*FLOOR BOX MT 14*

- floor box MT 14
- metal, colour silver RAL 9006
- mounting frame MODUL 2x7M included
- mounting dimensions 230x230mm, depth min 95mm
- floor lining thickness up to 10mm
- in accordance with EN 50085-1 and EN 50085-2-2



RB43

**TALNA DOZA MT 14 H=88mm**

- talna doza MT 14
- kovinska, barva srebrna RAL 9006
- nosilca MODUL 2x7M vgrajena
- vgradna mera 230x230mm, globina min 120mm
- debelina talne obloge pokrova do 10mm
- ustreza EN 50085-1 in EN 50085-2-2

*FLOOR BOX MT 14 H=88mm*

- floor box MT 14
- metal, colour silver RAL 9006
- mounting frames MODUL 2x7M included
- mounting dimensions 230x230mm, depth min 120mm
- floor lining thickness up to 10mm
- in accordance with EN 50085-1 and EN 50085-2-2

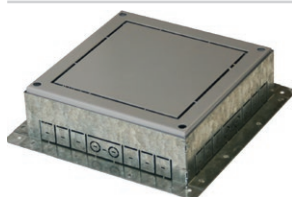

---

**PODSTAVEK TALNE DOZE MT 14**

RB34

- podstavek talne doze za pokrov MT 14
- kovinski, cinkan
- za vgradnjo v tlak ali dvojni pod
- nastavljiva višina 95-125mm
- ustreza EN 50085-1 in EN 50085-2-2

**FLOOR BOX FLANGE MT 14**

- floor box flange for box cover MT 14
- metal, galvanized
- for installation in a floor or double floor
- adjustable height 95-125mm
- in accordance with EN 50085-1 and EN 50085-2-2

---

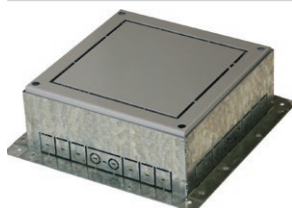
**PODSTAVEK TALNE DOZE MT 14 H=88mm**

RB44

- podstavek talne doze za pokrov MT 14 H=88mm
- kovinski, cinkan
- za vgradnjo v tlak ali dvojni pod
- nastavljiva višina 125-150mm
- ustreza EN 50085-1 in EN 50085-2-2

**FLOOR BOX FLANGE MT 14 H=88mm**

- floor box flange for box cover MT 14 H=88mm
- metal, galvanized
- for installation in a floor or double floor
- adjustable height 125-150mm
- in accordance with EN 50085-1 and EN 50085-2-2

---

**TALNA DOZA MT 21**

RB36

- talna doza MT 21
- kovinska, barva srebrna RAL 9006
- nosilci MODUL 3x7M vgrajeni
- vgradna mera 320x230mm, globina min 95mm
- debelina talne obloge pokrova do 10mm
- ustreza EN 50085-1 in EN 50085-2-2

**FLOOR BOX MT 21**

- floor box MT 21
- metal, colour silver RAL 9006
- mounting frames MODUL 3x7M included
- mounting dimensions 320x230mm, depth min 95mm
- floor lining thickness up to 10mm
- in accordance with EN 50085-1 and EN 50085-2-2

---

**TALNA DOZA MT 21 H=88mm**



RB46

- talna doza MT 21
- kovinska, barva srebrna RAL 9006
- nosilci MODUL 3x7M vgrajeni
- vgradna mera 320x230mm, globina min 120mm
- debelina talne obloge pokrova do 10mm
- ustreza EN 50085-1 in EN 50085-2-2

**FLOOR BOX MT 21 H=88mm**

- floor box MT 21
- metal, colour silver RAL 9006
- mounting frames MODUL 3x7M included
- mounting dimensions 320x230mm, depth min 120mm
- floor lining thickness up to 10mm
- in accordance with EN 50085-1 and EN 50085-2-2

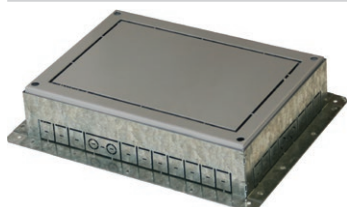
---

**PODSTAVEK TALNE DOZE MT 21**

RB37

- podstavek talne doze za pokrov MT 21
- kovinski, cinkan
- za vgradnjo v tlak ali dvojni pod
- nastavljiva višina 95-125mm
- ustreza EN 50085-1 in EN 50085-2-2

**FLOOR BOX FLANGE MT 21**

- floor box flange for box cover MT 21
- metal, galvanized
- for installation in a floor or double floor
- adjustable height 95-125mm
- in accordance with EN 50085-1 and EN 50085-2-2

---

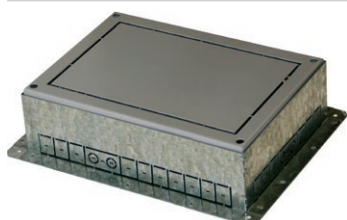
**PODSTAVEK TALNE DOZE MT 21 H=88mm**

RB47

- podstavek talne doze za pokrov MT 21 H=88mm
- kovinski, cinkan
- za vgradnjo v tlak ali dvojni pod
- nastavljiva višina 125-150mm
- ustreza EN 50085-1 in EN 50085-2-2

**FLOOR BOX FLANGE MT 21 H=88mm**

- floor box flange for box cover MT 21 H=88mm
- metal, galvanized
- for installation in a floor or double floor
- adjustable height 125-150mm
- in accordance with EN 50085-1 and EN 50085-2-2

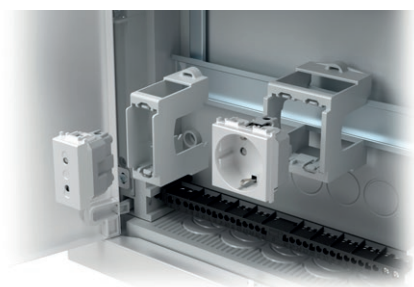

RB20

tip type	naziv description	tehnični opis technical data
RB10	ADAPTER ZA DIN LETEV ADAPTER FOR DIN RAIL	35mm 1M
RB11	ADAPTER ZA DIN LETEV ADAPTER FOR DIN RAIL	35mm 2M
RB20	RAZVODNA OMARICA DISTRIBUTION BOX	MO 12+2
⋮	⋮	⋮

#### ADAPTER ZA DIN LETEV 35mm 1M



RB10

- adapter MODUL 1M
- za DIN letev 35mm
- ustreza EN 50022

#### ADAPTER FOR DIN RAIL 35mm 1M

- adapter MODUL 1M
- for DIN rail 35mm
- in accordance with EN 50022

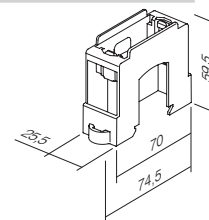

#### ADAPTER ZA DIN LETEV 35mm 2M



RB11

- adapter MODUL 2M
- za DIN letev 35mm
- ustreza EN 50022

#### ADAPTER FOR DIN RAIL 35mm 2M

- adapter MODUL 2M
- for DIN rail 35mm
- in accordance with EN 50022

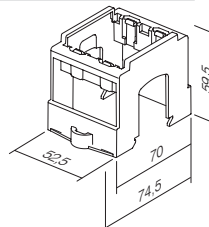

**RAZVODNA OMARICA MO 12+2**



RB20

- razvodna omarica MO enoredna 12+2MU
- 400V~, razred zaščite II, IP40
- kovinska vratca in okvir, barva bela RAL 9016
- ozemljitvene in ničelne sponke priložene
- za vgradnjo v zid
- ustreza EN 60670-1 in IEC 60670-24

**DISTRIBUTION BOX MO 12+2**

- distribution box MO single row 12+2MU
- 400V~, Class II, IP40
- metal leveling frame and door, colour white RAL 9016
- neutral and earth conductor terminals enclosed
- for brick wall mounting
- in accordance with EN 60670-1 and IEC 60670-24

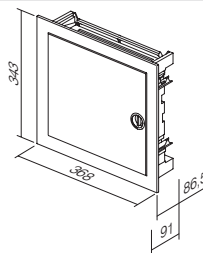

RB20V0

- za vgradnjo v votle stene
- for hollow wall mounting

**RAZVODNA OMARICA MO 24+4**



RB21

- razvodna omarica MO dvoredna 24+4MU
- 400V~, razred zaščite II, IP40
- kovinska vratca in okvir, barva bela RAL 9016
- ozemljitvene in ničelne sponke priložene
- za vgradnjo v zid
- ustreza EN 60670-1 in IEC 60670-24

**DISTRIBUTION BOX MO 24+4**

- distribution box MO double row 24+4MU
- 400V~, Class II, IP40
- metal leveling frame and door, colour white RAL 9016
- neutral and earth conductor terminals enclosed
- for brick wall mounting
- in accordance with EN 60670-1 and IEC 60670-24

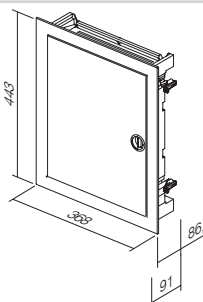

RB21V0

- za vgradnjo v votle stene
- for hollow wall mounting

**RAZVODNA OMARICA MO 36+6**



RB22

- razvodna omarica MO triredna 36+6MU
- 400V~, razred zaščite II, IP40
- kovinska vratca in okvir, barva bela RAL 9016
- ozemljitvene in ničelne sponke priložene
- za vgradnjo v zid
- ustreza EN 60670-1 in IEC 60670-24

**DISTRIBUTION BOX MO 36+6**

- distribution box MO triple row 36+6 MU
- 400V~, Class II, IP40
- metal leveling frame and door, colour white RAL 9016
- neutral and earth conductor terminals enclosed
- for brick wall mounting
- in accordance with EN 60670-1 and IEC 60670-24

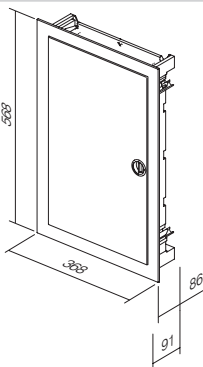

RB22V0

- za vgradnjo v votle stene
- for hollow wall mounting

**RAZVODNA OMARICA MO 48+8**



RB23

- razvodna omarica MO štiriredna 48+8MU
- 400V~, razred zaščite II, IP40
- kovinska vratca in okvir, barva bela RAL 9016
- ozemljitvene in ničelne sponke priložene
- za vgradnjo v zid
- ustreza EN 60670-1 in IEC 60670-24

**DISTRIBUTION BOX MO 48+8**

- distribution box MO quad row 48+8 MU
- 400V~, Class II, IP40
- metal leveling frame and door, colour white RAL 9016
- neutral and earth conductor terminals enclosed
- for brick wall mounting
- in accordance with EN 60670-1 and IEC 60670-24

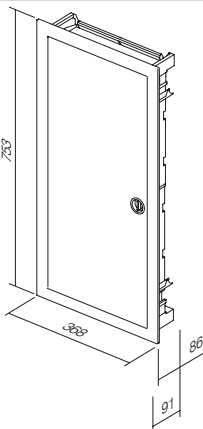

RB23V0

- za vgradnjo v votle stene
- for hollow wall mounting

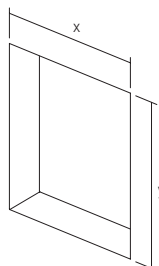

	RB20 RB20V0	RB21 RB21V0	RB22 RB22V0	RB23 RB23V0
x	314	314	314	314
y	314	414	539	724







ekonomik<sup>®</sup>



Planned for excellence  
Style is essential



ERGO

METAL

SOFT

Nevtralen, kompakten, eleganten dizajn se prilagodi v vsako okolje, v katerem bivate ali delate. V interierju ne izstopa, temveč z njim harmonično zaživi.

A neutral, compact, elegant design is adjustable to every working or living area. It does not stick out from the interior, but rather harmonically fits into it.





## Načrtovano za odličnost Bistven je slog



Čista linija ekonomik je nežno zaobljena, preišljena ergonomija posebej za vas.

A pure line is slightly curved - well considered ergonomics especially for you.



Izbirate lahko med sijajno refleksnimi površinami in sodobnim kovinskim izgledom.

You can choose between shiny reflective surfaces and modern metallic look.



Mehkost oblike bo našla prostor v modernih in klasičnih interierjih.

The softness of the form will find its place in modern as well as in classic interiors.



HARMONY

REFLEX

UV PROTECT

Želje so različne. Zato smo za vas pozorno izbrali možnosti, ki vam nudijo pravi odgovor. Nevtralna paleta barv bo le dopolnila vaš ambient - ne bo vas omejevala.

Desires can be very different. Therefore we have carefully selected possibilities for you, which can offer you the right answer. A neutral palette of colours will only complement your ambient - it will not restrict it.

Press and the world will spring to life  
Colourful landscape between walls



Refleksne občutke vam nudijo sijajni polimerni materiali v beli in biserno beli (beige) barvi.

Shiny polymer materials in white and beige colours enable reflective mood.



Moderen in nevtralen je tudi izbrani dekorativni kovinski nanos.

Selected decorative metallic coat is at the same time modern and neutral.

# Pritisnite in svet bo zaživel

## Barvita pokrajina med stenami



Za vse vas, ki se želite igrati s pastelnimi barvami, je rešitev Ekonomik Color.

For those who want to play with pastel colours Ekonomik Color represents a perfect solution.



Robustnost in visoka odpornost na zunanje vplive (UV) sta zagotovljeni z duroplastičnim materialom (Color).

Robustness and high resistance to external effects (UV) are secured by duroplastic materials (Color line).

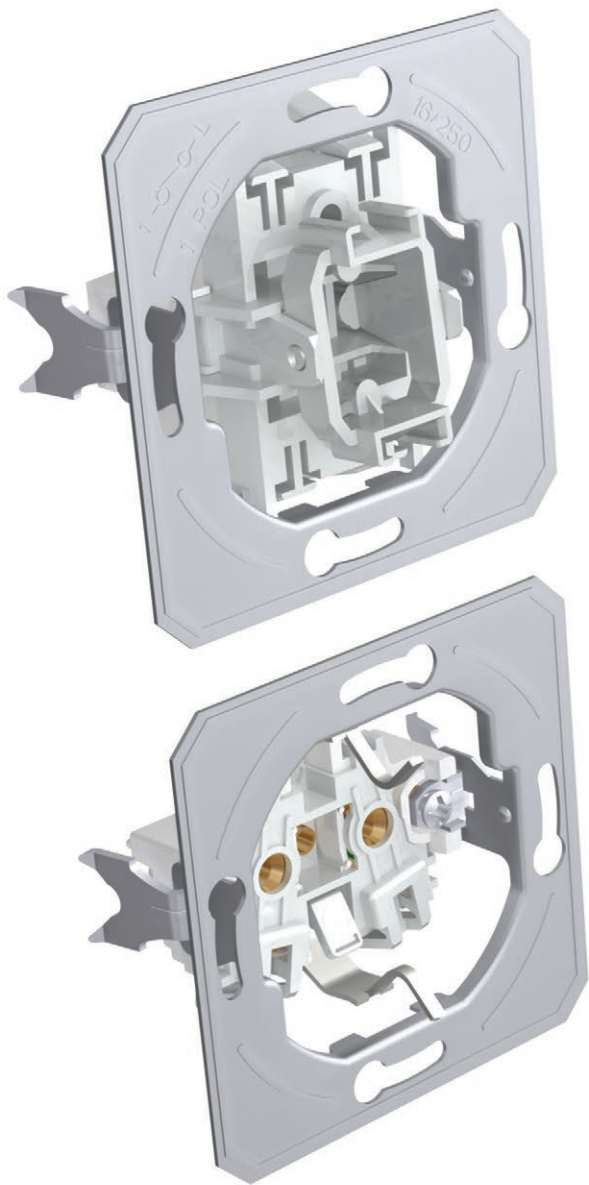

VERTICAL

HORIZONTAL

SAVE SPACE



S sestavljanjem prihranite prostor na steni. Ko imate malo prostora, je navpično prava odločitev.

With combining you save space on the wall. When faced with a limited space, »vertically« is the right decision.



Kombinirajte kot sami želite.

Combine as you please.



Vidni elementi se enostavno demontirajo. Hvaležni vam bodo tudi pleskarski mojstri.

Visible elements can be easily taken apart. Painters will be grateful to you.



Prolonge your day with a touch  
Simplified living

## Z dotikom si podaljšamo dan Poenostavljeno bivanje

Ekonomik je rešitev za sistem standardnih okroglih doz. Z njim lahko načrtujete tako enostavne kot tudi zahtevnejše inštalacije, novogradnje in adaptacije. Sistem odlikujejo brezvijačni kontakti, ki vam prihranijo čas pri vgradnji elementov.

Ekonomik is a solution for the system of standardized round installations boxes. It can be used for simple as well as more demanding installations, new buildings and adaptations. The system is characterised by plug-in contacts which save time during installation of elements.



# Dobro počutje v varnem zavetju

## Popolno zaupanje v dobro konstrukcijo

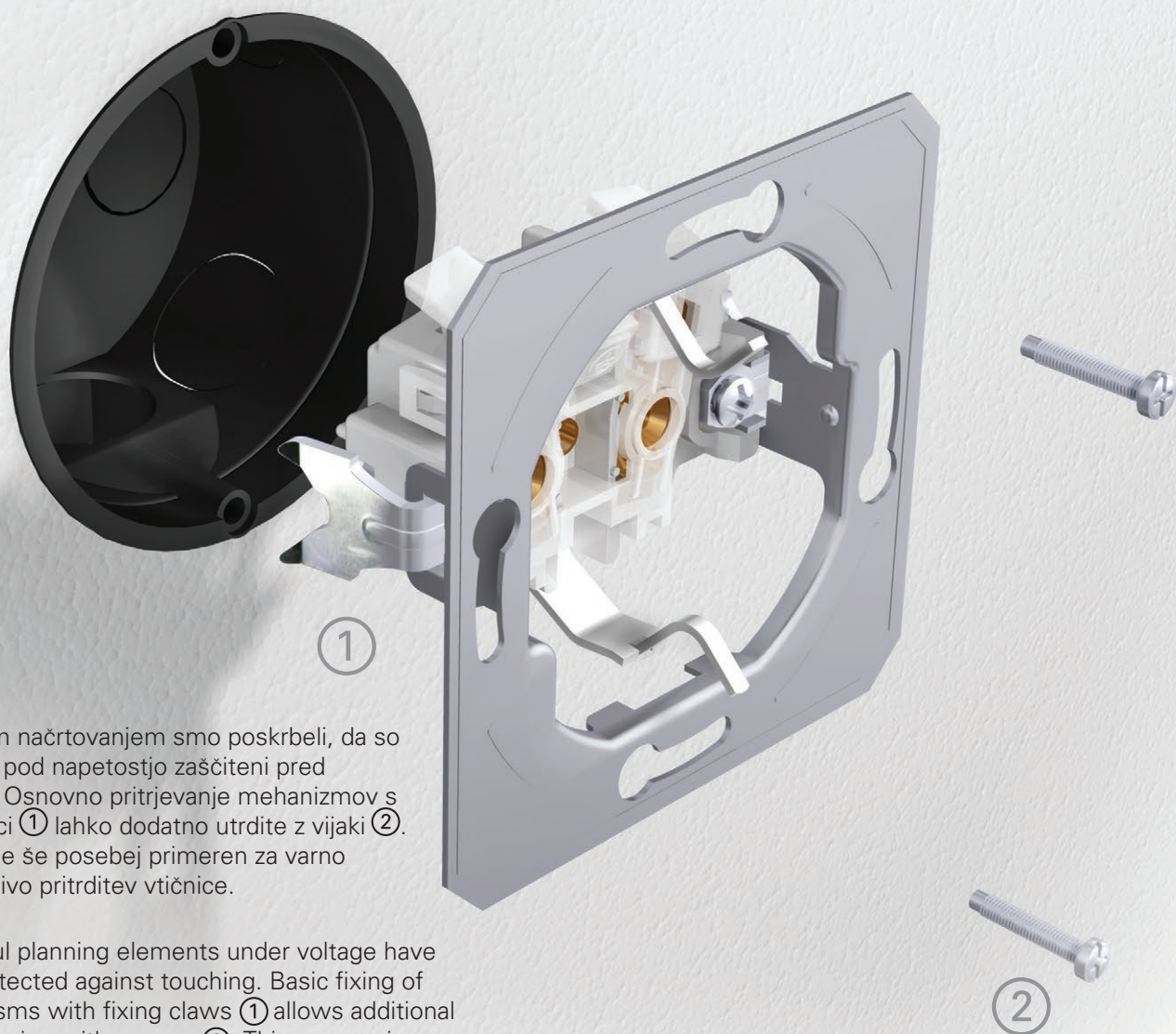

S skrbnim načrtovanjem smo poskrbeli, da so elementi pod napetostjo zaščiteni pred dotikom. Osnovno pritrjevanje mehanizmov s krepeljci ① lahko dodatno utrdite z vijaki ②. Ta način je še posebej primeren za varno in zanesljivo pritrnitev vtičnice.

By careful planning elements under voltage have been protected against touching. Basic fixing of mechanisms with fixing claws ① allows additional strengthening with screws ②. This manner is especially appropriate for safe and reliable fixing of sockets.

SIMPLE

FAST

FLEX

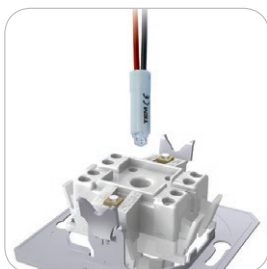

Dobro premišljena konstrukcija stikala omogoča enostavno osvetlitev tudi naknadno.

A well-planned switch construction makes easy illumination possible also subsequently.



Brezvijačni kontakti omogočajo hitro in zanesljivo priključitev vodnikov. Na isti kontakt lahko pritrdite dva vodnika različnih premerov.

Plug-in contacts enable quick and reliable attachment of wires. Two wires of different diameters can be attached to the same contact.

Sestavljive doze vam bodo olajšale delo. Prave razdalje so vam zagotovljene.

Easy-fitting installation boxes will make your work easier. Proper lengths are guaranteed.



## Feeling well in a safe shelter Total confidence in a good construction

SAFE

THRUST

CERTIFIED

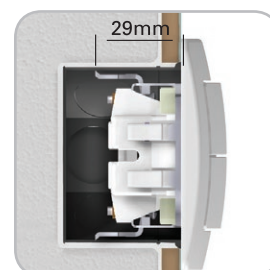

Krepeljci omogočajo globljo pritrditev (tudi preko keramičnih ploščic ipd.).

Fixing claws enable deeper fixing (also through ceramic tiles, etc.)



Vsa stikala imajo jasno identifikacijo z zadnje strani.

All switches have a clear identification in the back.

Stikala so preizkušena po mednarodnih standardnih, ki zagotavljajo varnost in dolgo življenjsko dobo.

Switches were tested according to international standards which guarantee safety and long life span.



Za zanesljivost preklopa skrbijo kontakti iz srebrne zlitine (AgNi).





Contacts made of silver alloy (Ag-Ni) guarantee safe switching.

TEM



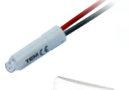



STIKALA SE <i>SWITCHES SE</i>		188
TIPKE TE <i>BUTTONS TE</i>		192
INDIKACIJA IA <i>ILLUMINATION IA</i>		193
VTIČNICE VE <i>SOCKETS VE</i>		196
KOMUNIKACIJE KE <i>COMMUNICATIONS KE</i>		199
POKROVI PE <i>COVERS PE</i>		204
ELEKTRONIKA EE <i>ELECTRONICS EE</i>		205
PRIBOR AE <i>ACCESSORIES AE</i>		210
OKVIRJI OE <i>SURROUNDS OE</i>		212



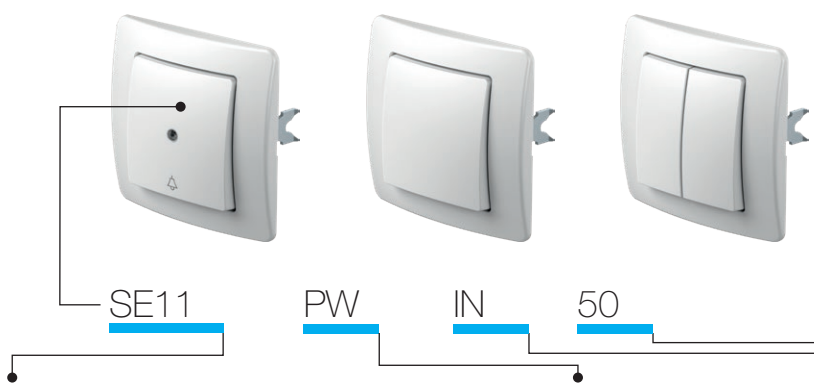

tip type	naziv description	tehnični opis technical data	barva colour	opcijski opis 1 optional data 1	opcijski opis 2 optional data 2
SE10	STIKALO ENOPOLNO SWITCH 1WAY	10AX 250V~	<input type="checkbox"/> PW bela-sijaj polar white	NT nevtral neutral	50
SE11	TIPKALO ENOPOLNO PUSH BUTTON 1WAY	10A 250V~	<input type="checkbox"/> IW bež-sijaj ivory white	IN indikator indicator	51
SE22	STIKALO DVOPOLNO SWITCH 2POLE	16AX 250V~	<input type="checkbox"/> ES srebrna-mat elox silver		03
...	...	...	<input type="checkbox"/> CO beli duroplast white thermoset		04
...	...	...	<input type="checkbox"/> NB črna-sijaj night black		...

**STIKALO ENOPOLNO 10AX 250V~**



SE10

- 10AX 250V~, tip SE10
- ustreza EN 60669-1
- brezvijačna pritrditev vodnikov 1.5-2.5mm<sup>2</sup>



- SWITCH 1WAY 10AX 250V~**
- 10AX 250V~, type SE10
  - in accordance with EN 60669-1
  - plug-in contacts 1.5-2.5mm<sup>2</sup>

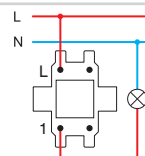

**TIPKALO ENOPOLNO 10A 250V~**



SE11

- 10A 250V~, tip SE11
- ustreza EN 60669-1
- brezvijačna pritrditev vodnikov 1.5-2.5mm<sup>2</sup>

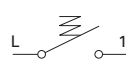

- PUSH BUTTON 1WAY 10A 250V~**
- 10A 250V~, type SE11
  - in accordance with EN 60669-1
  - plug-in contacts 1.5-2.5mm<sup>2</sup>

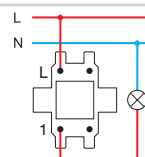

**STIKALO DVOPOLNO 16AX 250V~**

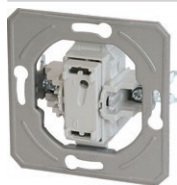

SE22

- 16AX 250V~, tip SE22
- ustreza EN 60669-1
- vijačna pritrditev vodnikov 1.5-2.5mm<sup>2</sup>
- samo v kombinaciji s tipko TE10\_\_NT03

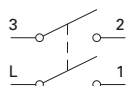

- SWITCH 2POLE 16AX 250V~**
- 16AX 250V~, type SE22
  - in accordance with EN 60669-1
  - screw contacts 1.5-2.5mm<sup>2</sup>
  - only in combination with button TE10\_\_NT03

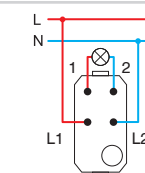

**STIKALO SERIJSKO 10AX 250V~**



SE50

- 10AX 250V~, tip SE50
- ustreza EN 60669-1
- brezvijačna pritrditev vodnikov 1.5-2.5mm<sup>2</sup>

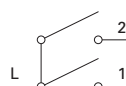

- SWITCH 2GANG-1WAY 10AX 250V~**
- 10AX 250V~, type SE50
  - in accordance with EN 60669-1
  - plug-in contacts 1.5-2.5mm<sup>2</sup>

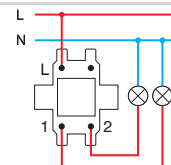

## TIPKALO SERIJSKO 10A 250V~

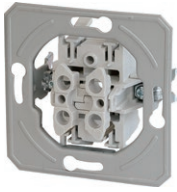

SE51

- 10A 250V~, tip SE51
- ustreza EN 60669-1
- brezvijačna pritrditev vodnikov 1.5-2.5mm<sup>2</sup>

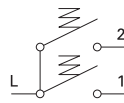

## PUSH BUTTON 2GANG-1WAY 10A 250V~

- 10A 250V~, type SE51
- in accordance with EN 60669-1
- plug-in contacts 1.5-2.5mm<sup>2</sup>

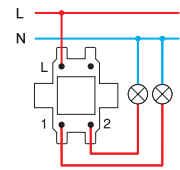

## STIKALO ŽALUZIJSKO 10AX 250V~



SE52

- 10AX 250V~, tip SE52
- ustreza EN 60669-1
- brezvijačna pritrditev vodnikov 1.5-2.5mm<sup>2</sup>
- z mehansko blokado hkratnega vklopa

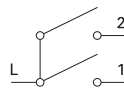

## SWITCH SHUTTERS 10AX 250V~

- 10AX 250V~, type SE52
- in accordance with EN 60669-1
- plug-in contacts 1.5-2.5mm<sup>2</sup>
- with mechanical interblock

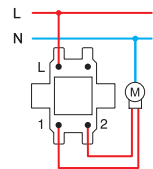

## TIPKALO ŽALUZIJSKO 10A 250V~



SE53

- 10A 250V~, tip SE53
- ustreza EN 60669-1
- brezvijačna pritrditev vodnikov 1.5-2.5mm<sup>2</sup>
- z mehansko blokado hkratnega vklopa

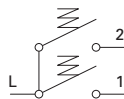

## PUSH BUTTON SHUTTERS 10A 250V~

- 10A 250V~, type SE53
- in accordance with EN 60669-1
- plug-in contacts 1.5-2.5mm<sup>2</sup>
- with mechanical interblock

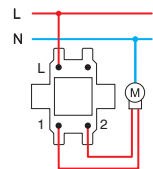

## STIKALO MENJALNO 10AX 250V~



SE60

- 10AX 250V~, tip SE60
- ustreza EN 60669-1
- brezvijačna pritrditev vodnikov 1.5-2.5mm<sup>2</sup>

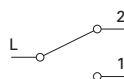

## SWITCH 2WAY 10AX 250V~

- 10AX 250V~, type SE60
- in accordance with EN 60669-1
- plug-in contacts 1.5-2.5mm<sup>2</sup>

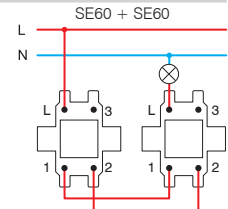

## STIKALO DVOJNO MENJALNO 10AX 250V~



SE63

- 10AX 250V~, tip SE63
- ustreza EN 60669-1
- brezvijačna pritrditev vodnikov 1.5-2.5mm<sup>2</sup>



## SWITCH DOUBLE 2WAY 10AX 250V~

- 10AX 250V~, type SE63
- in accordance with EN 60669-1
- plug-in contacts 1.5-2.5mm<sup>2</sup>

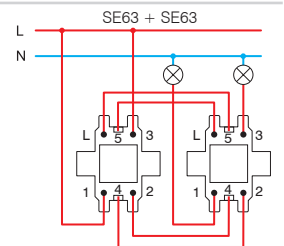

## STIKALO KRIŽNO 10AX 250V~



SE70

- 10AX 250V~, tip SE70
- ustreza EN 60669-1
- brezvijačna pritrditev vodnikov 1.5-2.5mm<sup>2</sup>



## SWITCH INTERMEDIATE 10AX 250V~

- 10AX 250V~, type SE70
- in accordance with EN 60669-1
- plug-in contacts 1.5-2.5mm<sup>2</sup>

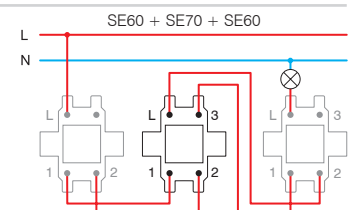

STIKALO ENOPOLNO 10AX 250V~



- SE10PW
- SE10IW
- SE10ES
- SE10CO
- SE10NB

- 10AX 250V~, tip SE10  
- ustreza EN 60669-1  
- brezvijačna pritrditev vodnikov 1.5-2.5mm<sup>2</sup>

SWITCH 1WAY 10AX 250V~

- 10AX 250V~, type SE10  
- in accordance with EN 60669-1  
- plug-in contacts 1.5-2.5mm<sup>2</sup>



STIKALO ENOPOLNO 10AX 250V~ \_\_ IN



- SE10PWIN
- SE10IWIN
- SE10ESIN
- SE10COIN
- SE10NBIN

- IN indikator  
- 10AX 250V~, tip SE10  
- ustreza EN 60669-1  
- brezvijačna pritrditev vodnikov 1.5-2.5mm<sup>2</sup>

SWITCH 1WAY 10AX 250V~ \_\_ IN

- IN indicator  
- 10AX 250V~, type SE10  
- in accordance with EN 60669-1  
- plug-in contacts 1.5-2.5mm<sup>2</sup>



TIPKALO ENOPOLNO 10A 250V~



- SE11PW
- SE11IW
- SE11ES
- SE11CO
- SE11NB

- 10A 250V~, tip SE11  
- ustreza EN 60669-1  
- brezvijačna pritrditev vodnikov 1.5-2.5mm<sup>2</sup>

PUSH BUTTON 1WAY 10A 250V~

- 10A 250V~, type SE11  
- in accordance with EN 60669-1  
- plug-in contacts 1.5-2.5mm<sup>2</sup>



TIPKALO ENOPOLNO 10A 250V~ \_\_ TI 50



- SE11PWTI50
- SE11IWTI50
- SE11ESTI50
- SE11COTI50
- SE11NBTI50

- TI 50 indikator zvonec+tlivka  
- 10A 250V~, tip SE11  
- ustreza EN 60669-1  
- brezvijačna pritrditev vodnikov 1.5-2.5mm<sup>2</sup>

PUSH BUTTON 1WAY 10A 250V~ \_\_ TI 50

- TI 50 indicator bell+neon lamp  
- 10A 250V~, type SE11  
- in accordance with EN 60669-1  
- plug-in contacts 1.5-2.5mm<sup>2</sup>



TIPKALO ENOPOLNO 10A 250V~ \_\_ TI 51



- SE11PWTI51
- SE11IWTI51
- SE11ESTI51
- SE11COTI51
- SE11NBTI51

- TI 51 indikator luč+tlivka  
- 10A 250V~, tip SE11  
- ustreza EN 60669-1  
- brezvijačna pritrditev vodnikov 1.5-2.5mm<sup>2</sup>

PUSH BUTTON 1WAY 10A 250V~ \_\_ TI 51

- TI 51 indicator light+neon lamp  
- 10A 250V~, type SE11  
- in accordance with EN 60669-1  
- plug-in contacts 1.5-2.5mm<sup>2</sup>



TIPKALO ENOPOLNO 10A 250V~ \_\_ IL



- SE11PWIL
- SE11IWIL
- SE11ESIL
- SE11COIL
- SE11NBIL

- IL napisna ploščica  
- 10A 250V~, tip SE11  
- ustreza EN 60669-1  
- brezvijačna pritrditev vodnikov 1.5-2.5mm<sup>2</sup>

PUSH BUTTON 1WAY 10A 250V~ \_\_ IL

- IL inscription plate  
- 10A 250V~, type SE11  
- in accordance with EN 60669-1  
- plug-in contacts 1.5-2.5mm<sup>2</sup>



STIKALO DVOPOLNO 16AX 250V~ \_\_ IN 03



- SE22PWIN03
- SE22IWIN03
- SE22ESIN03
- SE22NBIN03

- IN 03 nevtral 0-1  
- 16AX 250V~, tip SE22  
- ustreza EN 60669-1  
- vijajčna pritrditev vodnikov 1.5-2.5mm<sup>2</sup>

SWITCH 2POLE 16AX 250V~ \_\_ IN 03

- IN 03 neutral 0-1  
- 16AX 250V~, type SE22  
- in accordance with EN 60669-1  
- screw contacts 1.5-2.5mm<sup>2</sup>



	<ul style="list-style-type: none"> <li><input type="checkbox"/> SE50PW</li> <li><input type="checkbox"/> SE50IW</li> <li><input type="checkbox"/> SE50ES</li> <li><input type="checkbox"/> SE50CO</li> <li><input type="checkbox"/> SE50NB</li> </ul>	<p><b>STIKALO SERIJSKO 10AX 250V~</b></p> <ul style="list-style-type: none"> <li>- 10AX 250V~, tip SE50</li> <li>- ustreza EN 60669-1</li> <li>- brezvijačna pritrditev vodnikov 1.5-2.5mm<sup>2</sup></li> </ul> <p><i>SWITCH 2GANG-1WAY 10AX 250V~</i></p> <ul style="list-style-type: none"> <li>- 10AX 250V~, type SE50</li> <li>- in accordance with EN 60669-1</li> <li>- plug-in contacts 1.5-2.5mm<sup>2</sup></li> </ul>	
	<ul style="list-style-type: none"> <li><input type="checkbox"/> SE51PW</li> <li><input type="checkbox"/> SE51IW</li> <li><input type="checkbox"/> SE51ES</li> <li><input type="checkbox"/> SE51CO</li> <li><input type="checkbox"/> SE51NB</li> </ul>	<p><b>TIPKALO SERIJSKO 10A 250V~</b></p> <ul style="list-style-type: none"> <li>- 10A 250V~, tip SE51</li> <li>- ustreza EN 60669-1</li> <li>- brezvijačna pritrditev vodnikov 1.5-2.5mm<sup>2</sup></li> </ul> <p><i>PUSH BUTTON 2GANG-1WAY 10A 250V~</i></p> <ul style="list-style-type: none"> <li>- 10A 250V~, type SE51</li> <li>- in accordance with EN 60669-1</li> <li>- plug-in contacts 1.5-2.5mm<sup>2</sup></li> </ul>	
	<ul style="list-style-type: none"> <li><input type="checkbox"/> SE52PWNT09</li> <li><input type="checkbox"/> SE52IWNT09</li> <li><input type="checkbox"/> SE52ESNT09</li> <li><input type="checkbox"/> SE52CONT09</li> <li><input type="checkbox"/> SE52NBNT09</li> </ul>	<p><b>STIKALO ŽALUZIJSKO 10AX 250V~ __ NT 09</b></p> <ul style="list-style-type: none"> <li>- NT 09 nevtral gor-dol</li> <li>- 10AX 250V~, tip SE52</li> <li>- ustreza EN 60669-1</li> <li>- brezvijačna pritrditev vodnikov 1.5-2.5mm<sup>2</sup></li> <li>- z mehansko blokado hkratnega vklopa</li> </ul> <p><i>SWITCH SHUTTERS 10AX 250V~ __ NT 09</i></p> <ul style="list-style-type: none"> <li>- NT 09 neutral up-down</li> <li>- 10AX 250V~, type SE52</li> <li>- in accordance with EN 60669-1</li> <li>- plug-in contacts 1.5-2.5mm<sup>2</sup></li> <li>- with mechanical interblock</li> </ul>	
	<ul style="list-style-type: none"> <li><input type="checkbox"/> SE53PWNT09</li> <li><input type="checkbox"/> SE53IWNT09</li> <li><input type="checkbox"/> SE53ESNT09</li> <li><input type="checkbox"/> SE53CONT09</li> <li><input type="checkbox"/> SE53NBNT09</li> </ul>	<p><b>TIPKALO ŽALUZIJSKO 10A 250V~ __ NT 09</b></p> <ul style="list-style-type: none"> <li>- NT 09 nevtral gor-dol</li> <li>- 10A 250V~, tip SE53</li> <li>- ustreza EN 60669-1</li> <li>- brezvijačna pritrditev vodnikov 1.5-2.5mm<sup>2</sup></li> <li>- z mehansko blokado hkratnega vklopa</li> </ul> <p><i>PUSH BUTTON SHUTTERS 10A 250V~ __ NT 09</i></p> <ul style="list-style-type: none"> <li>- NT 09 neutral up-down</li> <li>- 10A 250V~, type SE53</li> <li>- in accordance with EN 60669-1</li> <li>- plug-in contacts 1.5-2.5mm<sup>2</sup></li> <li>- with mechanical interblock</li> </ul>	
	<ul style="list-style-type: none"> <li><input type="checkbox"/> SE60PW</li> <li><input type="checkbox"/> SE60IW</li> <li><input type="checkbox"/> SE60ES</li> <li><input type="checkbox"/> SE60CO</li> <li><input type="checkbox"/> SE60NB</li> </ul>	<p><b>STIKALO MENJALNO 10AX 250V~</b></p> <ul style="list-style-type: none"> <li>- 10AX 250V~, tip SE60</li> <li>- ustreza EN 60669-1</li> <li>- brezvijačna pritrditev vodnikov 1.5-2.5mm<sup>2</sup></li> </ul> <p><i>SWITCH 2WAY 10AX 250V~</i></p> <ul style="list-style-type: none"> <li>- 10AX 250V~, type SE60</li> <li>- in accordance with EN 60669-1</li> <li>- plug-in contacts 1.5-2.5mm<sup>2</sup></li> </ul>	
	<ul style="list-style-type: none"> <li><input type="checkbox"/> SE63PW</li> <li><input type="checkbox"/> SE63IW</li> <li><input type="checkbox"/> SE63ES</li> <li><input type="checkbox"/> SE63CO</li> <li><input type="checkbox"/> SE63NB</li> </ul>	<p><b>STIKALO DVOJNO MENJALNO 10AX 250V~</b></p> <ul style="list-style-type: none"> <li>- 10AX 250V~, tip SE63</li> <li>- ustreza EN 60669-1</li> <li>- brezvijačna pritrditev vodnikov 1.5-2.5mm<sup>2</sup></li> </ul> <p><i>SWITCH DOUBLE 2WAY 10AX 250V~</i></p> <ul style="list-style-type: none"> <li>- 10AX 250V~, type SE63</li> <li>- in accordance with EN 60669-1</li> <li>- plug-in contacts 1.5-2.5mm<sup>2</sup></li> </ul>	
	<ul style="list-style-type: none"> <li><input type="checkbox"/> SE70PW</li> <li><input type="checkbox"/> SE70IW</li> <li><input type="checkbox"/> SE70ES</li> <li><input type="checkbox"/> SE70CO</li> <li><input type="checkbox"/> SE70NB</li> </ul>	<p><b>STIKALO KRIŽNO 10AX 250V~</b></p> <ul style="list-style-type: none"> <li>- 10AX 250V~, tip SE70</li> <li>- ustreza EN 60669-1</li> <li>- brezvijačna pritrditev vodnikov 1.5-2.5mm<sup>2</sup></li> </ul> <p><i>SWITCH INTERMEDIATE 10AX 250V~</i></p> <ul style="list-style-type: none"> <li>- 10AX 250V~, type SE70</li> <li>- in accordance with EN 60669-1</li> <li>- plug-in contacts 1.5-2.5mm<sup>2</sup></li> </ul>	

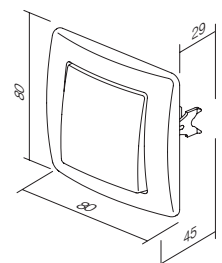
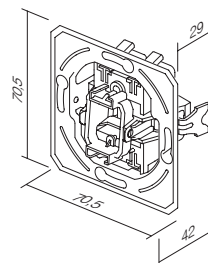



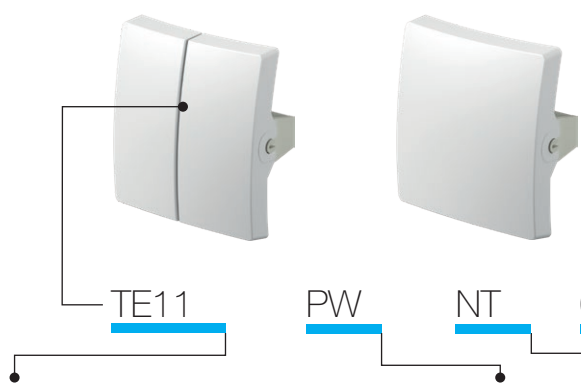

tip type	naziv description	barva colour	opciski opis 1 optional data 1	opciski opis 2 optional data 2
TE10	TIPKA NAVADNA BUTTON 1GANG	<input type="checkbox"/> PW bela-sijaj polar white	NT nevtral neutral	50
TE11	TIPKA SERIJSKA BUTTON 2GANG	<input type="checkbox"/> IW bež-sijaj ivory white	IN indikator indicator	51
...	...	<input type="checkbox"/> ES srebrna-mat elox silver		03
...	...	<input type="checkbox"/> CO beli duroplast white thermoset		04
...	...	<input type="checkbox"/> NB črna-sijaj night black		...

TIPKA NAVADNA



- TE10PW
- TE10IW
- TE10ES
- TE10CO
- TE10NB

- tipka skupaj z nosilcem  
**BUTTON 1GANG**  
- button together with carrier



TIPKA INDIKATOR

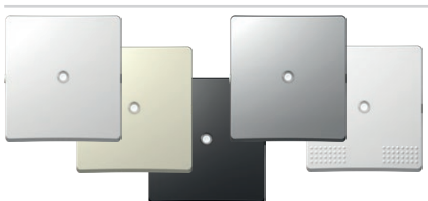

- TE10PWIN
- TE10IWIN
- TE10ESIN
- TE10COIN
- TE10NBIN

- tipka skupaj z nosilcem  
**BUTTON INDICATOR**  
- button together with carrier



TIPKA Z NAPISNO PLOŠČICO

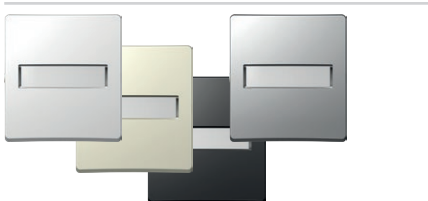

- TE13PWIL
- TE13IWIL
- TE13ESIL
- TE13NBIL

- tipka skupaj z nosilcem, z napisno ploščico  
**BUTTON WITH INSCRIPTION PLATE**  
- button together with carrier, with inscription plate



TIPKA SERIJSKA



- TE11PW
- TE11IW
- TE11ES
- TE11CO
- TE11NB

- tipka serijska skupaj z nosilcem  
**BUTTON 2GANG**  
- button 2gang together with carrier

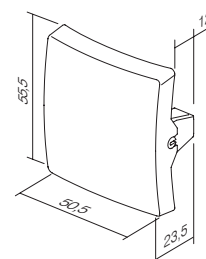
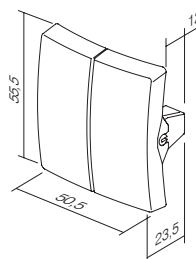

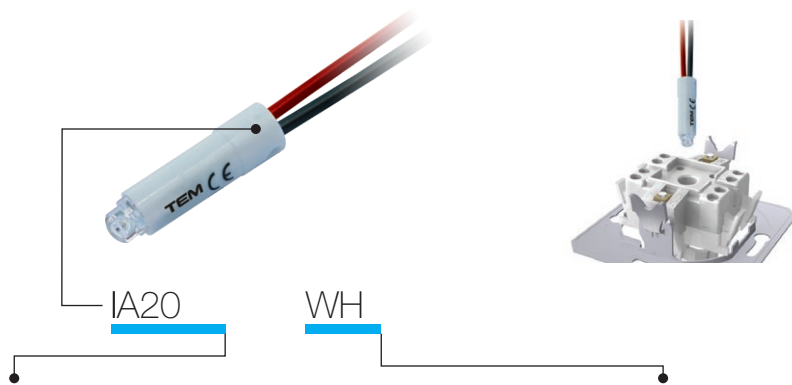

tip type	naziv description	tehnični opis technical data	barva colour
IA10	TLIVKA NEON LAMP	230V~ 0,34W	<input type="checkbox"/> WH bela white
IA20	SIJALKA LED LED LAMP	230V~ 0,40W	<input checked="" type="checkbox"/> BL modra blue
IA21	SIJALKA LED LED LAMP	24V AC/DC 0,20W	<input checked="" type="checkbox"/> RD rdeča red
·	·	·	<input checked="" type="checkbox"/> GR zelena green
·	·	·	<input checked="" type="checkbox"/> OR oranžna orange

#### TLIVKA 230V~ 0,34W



IA10OR

- za indikacijo, osvetlitev ali stalno osvetlitev stikala
- v kombinaciji s tipko z indikatorjem

*NEON LAMP 230V~ 0,34W*

- for indication, illumination or constant illumination of switch
- in combination with button with indicator

#### SIJALKA LED 230V AC/DC 0,40W



IA20WH  
 IA20GR  
 IA20RD  
 IA20BL

- za indikacijo, osvetlitev ali stalno osvetlitev stikala
- v kombinaciji s tipko z indikatorjem

*LED LAMP 230V AC/DC 0,40W*

- for indication, illumination or constant illumination of switch
- in combination with button with indicator

#### SIJALKA LED 24V AC/DC 0,20W

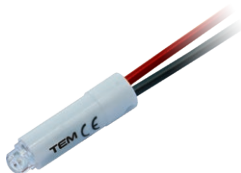

IA21WH  
 IA21RD

- za indikacijo, osvetlitev ali stalno osvetlitev stikala
- v kombinaciji s tipko z indikatorjem

*LED LAMP 24V AC/DC 0,20W*

- for indication, illumination or constant illumination of switch
- in combination with button with indicator

#### SIJALKA LED 12V AC/DC 0,10W

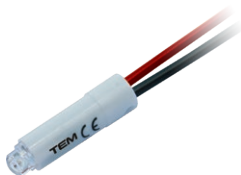

IA22WH  
 IA22RD

- za indikacijo, osvetlitev ali stalno osvetlitev stikala
- v kombinaciji s tipko z indikatorjem

*LED LAMP 12V AC/DC 0,10W*

- for indication, illumination or constant illumination of switch
- in combination with button with indicator

\* Indikacija /  
Indication

Osvetlitev /  
Illumination

\* Stalna osvetlitev /  
Illumination always on

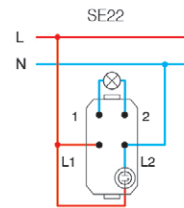
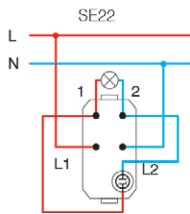
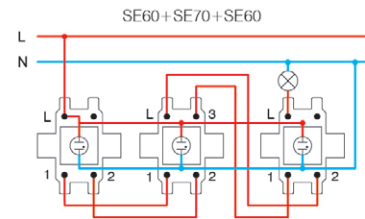
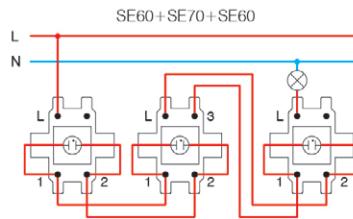
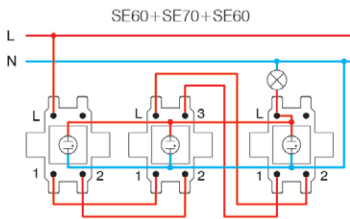
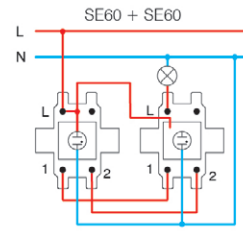
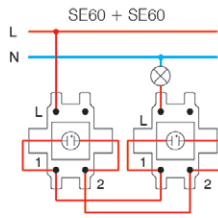
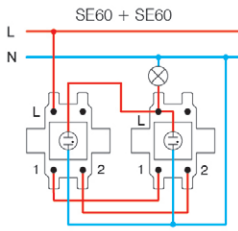
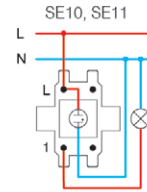
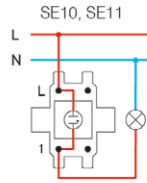
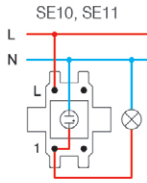

\* vezave primerne za varčne (CFL, LED) sijalke /  
wiring scheme for energy saving lamps (CFL, LED)

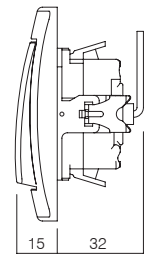

## S O C K E T S V E

VE11      PT      XO      KS

tip type	naziv description	tehnični opis technical data	opsijski opis 1 optional data 1	opsijski opis 2 optional data 2
VE10	VTIČNICA SCHUKO SOCKET SCHUKO	2P+E 16A 250V~	XO brez okvirja without cover plate	KS vgrajena zaščita pred dotikom kontaktov shuttered live contacts
VE11	VTIČNICA SCHUKO+POKROV SOCKET SCHUKO+COVER	2P+E 16A 250V~		
VE12	VTIČNICA SCHUKO SOCKET SCHUKO	2P+E 16A 250V~ BV	KS vgrajena zaščita pred dotikom kontaktov shuttered live contacts	
⋮	⋮	⋮		
⋮	⋮	⋮		

barva  
colour

<input type="checkbox"/> PW bela-sijaj polar white	<input checked="" type="checkbox"/> PT bela+prozorna white+transparent	<input type="checkbox"/> PP bela+bela white+white
<input checked="" type="checkbox"/> IW bež-sijaj ivory white	<input checked="" type="checkbox"/> IT bež+prozorna ivory+transparent	<input checked="" type="checkbox"/> II bež+bež ivory+ivory
<input type="checkbox"/> ES srebrna-mat elox silver	<input checked="" type="checkbox"/> ST srebrna+prozorna silver+transparent	<input type="checkbox"/> SS srebrna+srebrna silver+silver
<input type="checkbox"/> CO beli duroplast white thermoset	<input checked="" type="checkbox"/> CT bela+prozorna white+transparent	<input checked="" type="checkbox"/> BB črna+črna black+black
<input checked="" type="checkbox"/> NB črna-sijaj night black	<input checked="" type="checkbox"/> BT črna+prozorna black+transparent	<input checked="" type="checkbox"/> RR rdeča+rdeča red+red
<input checked="" type="checkbox"/> RD rdeča red	<input checked="" type="checkbox"/> RT rdeča+prozorna red+transparent	<input checked="" type="checkbox"/> GG zelena+zelena green+green
<input checked="" type="checkbox"/> GR zelena green	<input checked="" type="checkbox"/> GT zelena+prozorna green+transparent	<input checked="" type="checkbox"/> OO oranžna+oranžna orange+orange
<input checked="" type="checkbox"/> OR oranžna orange	<input checked="" type="checkbox"/> OT oranžna+prozorna orange+transparent	



schuko - ustreza EN 60884-1, CEE7 (list III)

francoska - ustreza NF C 61-314 (list V)

schuko - in accordance with EN 60884-1, CEE7 (standard sheet III)

French - in accordance with NF C 61-314 (standard sheet V)

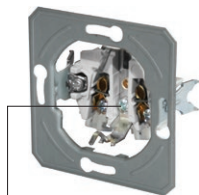

vijačna pritrditev vodnikov  
screw contacts

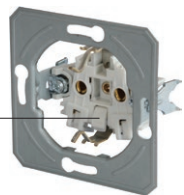

BV brezvijačna pritrditev vodnikov  
BV plug-in contacts

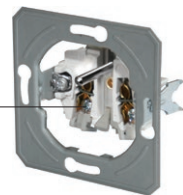

vijačna pritrditev vodnikov  
screw contacts



BV brezvijačna pritrditev vodnikov  
BV plug-in contacts



VTIČNICA SCHUKO 2P+E 16A 250V~ \_\_ XO



- VE10PWXO
- VE10IWXO
- VE10ESXO
- VE10COXO
- VE10NBXO
- VE10RDXO
- VE10GRXO
- VE10ORXO

- vijačna pritrditev vodnikov 1.5-2.5mm<sup>2</sup>
- XO brez okvirja
- 2P+E schuko
- 16A 250V~, tip VE10

SOCKET SCHUKO 2P+E 16A 250V~ \_\_ XO

- screw contacts 1.5-2.5mm<sup>2</sup>
- XO without surround
- 2P+E schuko
- 16A 250V~, type VE10



VTIČNICA SCHUKO+POKROV 2P+E 16A 250V~ \_\_ XO



- VE11PTXO
- VE11ITXO
- VE11STXO
- VE11BTXO

- vijačna pritrditev vodnikov 1.5-2.5mm<sup>2</sup>
- XO brez okvirja
- 2P+E schuko+pokrov
- 16A 250V~, tip VE11

SOCKET SCHUKO+COVER 2P+E 16A 250V~ \_\_ XO

- screw contacts 1.5-2.5mm<sup>2</sup>
- XO without surround
- 2P+E schuko+cover
- 16A 250V~, type VE11



VTIČNICA SCHUKO 2P+E 16A 250V~ BV \_\_ XO



- VE12PWXO
- VE12IWXO
- VE12ESXO
- VE12COXO
- VE12NBXO
- VE12RDXO
- VE12GRXO
- VE12ORXO

- BV brezvijačna pritrditev vodnikov 1.5-2.5mm<sup>2</sup>
- XO brez okvirja
- 2P+E schuko
- 16A 250V~, tip VE12

SOCKET SCHUKO 2P+E 16A 250V~ BV \_\_ XO

- BV plug-in contacts 1.5-2.5mm<sup>2</sup>
- XO without surround
- 2P+E schuko
- 16A 250V~, type VE12



VTIČNICA SCHUKO+POKROV 2P+E 16A 250V~ BV \_\_ XO

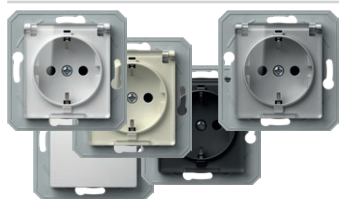

- VE13PTXO
- VE13ITXO
- VE13STXO
- VE13BTXO

- BV brezvijačna pritrditev vodnikov 1.5-2.5mm<sup>2</sup>
- XO brez okvirja
- 2P+E schuko+pokrov
- 16A 250V~, tip VE13

SOCKET SCHUKO+COVER 2P+E 16A 250V~ BV \_\_ XO

- BV plug-in contacts 1.5-2.5mm<sup>2</sup>
- XO without surround
- 2P+E schuko+cover
- 16A 250V~, type VE13



VTIČNICA SCHUKO 2P+E 16A 250V~



- VE10PW
- VE10IW
- VE10ES
- VE10CO
- VE10NB

- vijačna pritrditev vodnikov 1.5-2.5mm<sup>2</sup>
- 2P+E schuko
- 16A 250V~, tip VE10

SOCKET SCHUKO 2P+E 16A 250V~

- screw contacts 1.5-2.5mm<sup>2</sup>
- 2P+E schuko
- 16A 250V~, type VE10



VTIČNICA SCHUKO+POKROV 2P+E 16A 250V~



- VE11PT
- VE11IT
- VE11ST
- VE11CT
- VE11BT

- vijačna pritrditev vodnikov 1.5-2.5mm<sup>2</sup>
- 2P+E schuko+pokrov
- 16A 250V~, tip VE11

SOCKET SCHUKO+COVER 2P+E 16A 250V~

- screw contacts 1.5-2.5mm<sup>2</sup>
- 2P+E schuko+cover
- 16A 250V~, type VE11



VTIČNICA SCHUKO 2P+E 16A 250V~ BV



- VE12PW
- VE12IW
- VE12ES
- VE12CO
- VE12NB

- BV brezvijačna pritrditev vodnikov 1.5-2.5mm<sup>2</sup>
- 2P+E schuko
- 16A 250V~, tip VE12

SOCKET SCHUKO 2P+E 16A 250V~ BV

- BV plug-in contacts 1.5-2.5mm<sup>2</sup>
- 2P+E schuko
- 16A 250V~, type VE12



VTIČNICA SCHUKO+POKROV 2P+E 16A 250V~ BV

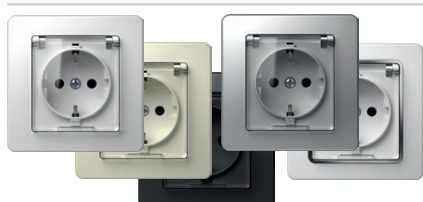

- VE13PT
- VE13IT
- VE13ST
- VE13CT
- VE13BT

- BV brezvijačna pritrditev vodnikov 1.5-2.5mm<sup>2</sup>
- 2P+E schuko+pokrov
- 16A 250V~, tip VE13

SOCKET SCHUKO+COVER 2P+E 16A 250V~ BV

- BV plug-in contacts 1.5-2.5mm<sup>2</sup>
- 2P+E schuko+cover
- 16A 250V~, type VE13





- VE40PWXO
- VE40IWXO
- VE40ESXO
- VE40COXO
- VE40NBXO
- VE40RDXO
- VE40GRXO
- VE40ORXO

## VTIČNICA FRANCOSKA 2P+E 16A 250V~ \_\_ XO

- vijačna pritrditev vodnikov 1.5-2.5mm<sup>2</sup>
- XO brez okvirja
- 2P+E francoska
- 16A 250V~, tip VE40

## SOCKET FRENCH 2P+E 16A 250V~ \_\_ XO

- screw contacts 1.5-2.5mm<sup>2</sup>
- XO without surround
- 2P+E French
- 16A 250V~, type VE40

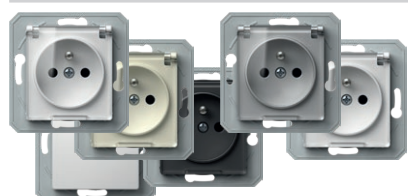

- VE41PTXO
- VE41ITXO
- VE41STXO
- VE41PTXO
- VE41BTXO
- VE41PPXO

## VTIČNICA FRANCOSKA+POKROV 2P+E 16A 250V~ \_\_ XO

- vijačna pritrditev vodnikov 1.5-2.5mm<sup>2</sup>
- XO brez okvirja
- 2P+E francoska+pokrov
- 16A 250V~, tip VE41

## SOCKET FRENCH+COVER 2P+E 16A 250V~ \_\_ XO

- screw contacts 1.5-2.5mm<sup>2</sup>
- XO without surround
- 2P+E French+cover
- 16A 250V~, type VE41



- VE42PWXO
- VE42IWXO
- VE42ESXO
- VE42COXO
- VE42NBXO
- VE42RDXO
- VE42GRXO
- VE42ORXO

## VTIČNICA FRANCOSKA 2P+E 16A 250V~ BV \_\_ XO

- BV brezvijačna pritrditev vodnikov 1.5-2.5mm<sup>2</sup>
- XO brez okvirja
- 2P+E francoska
- 16A 250V~, tip VE42

## SOCKET FRENCH 2P+E 16A 250V~ BV \_\_ XO

- BV plug-in contacts 1.5-2.5mm<sup>2</sup>
- XO without surround
- 2P+E French
- 16A 250V~, type VE42

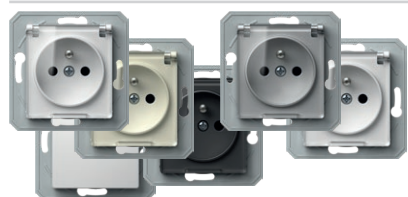

- VE43PTXO
- VE43ITXO
- VE43STXO
- VE43PTXO
- VE43BTXO
- VE43PPXO

## VTIČNICA FRANCOSKA+POKROV 2P+E 16A 250V~ BV \_\_ XO

- BV brezvijačna pritrditev vodnikov 1.5-2.5mm<sup>2</sup>
- XO brez okvirja
- 2P+E francoska+pokrov
- 16A 250V~, tip VE43

## SOCKET FRENCH+COVER 2P+E 16A 250V~ BV \_\_ XO

- BV plug-in contacts 1.5-2.5mm<sup>2</sup>
- XO without surround
- 2P+E French+cover
- 16A 250V~, type VE43



- VE40PW
- VE40IW
- VE40ES
- VE40CO
- VE40NB

## VTIČNICA FRANCOSKA 2P+E 16A 250V~

- vijačna pritrditev vodnikov 1.5-2.5mm<sup>2</sup>
- 2P+E francoska
- 16A 250V~, tip VE40

## SOCKET FRENCH 2P+E 16A 250V~

- screw contacts 1.5-2.5mm<sup>2</sup>
- 2P+E French
- 16A 250V~, type VE40



- VE41PT
- VE41IT
- VE41ST
- VE41CT
- VE41BT

## VTIČNICA FRANCOSKA+POKROV 2P+E 16A 250V~

- vijačna pritrditev vodnikov 1.5-2.5mm<sup>2</sup>
- 2P+E francoska+pokrov
- 16A 250V~, tip VE41

## SOCKET FRENCH+COVER 2P+E 16A 250V~

- screw contacts 1.5-2.5mm<sup>2</sup>
- 2P+E French+cover
- 16A 250V~, type VE41



- VE42PW
- VE42IW
- VE42ES
- VE42CO
- VE42NB

## VTIČNICA FRANCOSKA 2P+E 16A 250V~ BV

- BV brezvijačna pritrditev vodnikov 1.5-2.5mm<sup>2</sup>
- 2P+E francoska
- 16A 250V~, tip VE42

## SOCKET FRENCH 2P+E 16A 250V~ BV

- BV plug-in contacts 1.5-2.5mm<sup>2</sup>
- 2P+E French
- 16A 250V~, type VE42



- VE43PT
- VE43IT
- VE43ST
- VE43CT
- VE43BT

## VTIČNICA FRANCOSKA+KS+POKROV 2P+E 16A 250V~ BV

- BV brezvijačna pritrditev vodnikov 1.5-2.5mm<sup>2</sup>
- 2P+E francoska+pokrov
- 16A 250V~, tip VE43

## SOCKET FRENCH+COVER 2P+E 16A 250V~ BV

- BV plug-in contacts 1.5-2.5mm<sup>2</sup>
- 2P+E French+cover
- 16A 250V~, type VE43



VTIČNICA SCHUKO DVOJNA 2P+E 16A 250V~



- VE16PWKS
- VE16IWKS
- VE16ESKS
- VE16NBKS

- 2P+E schuko dvojna
- 16A 250V~, tip VE16
- ustreza IEC 60884-1, CEE7
- vijajčna pritrditev vodnikov 1,5-2,5 mm<sup>2</sup>
- KS zaščita pred dotikom kontaktov

SOCKET SCHUKO DOUBLE 2P+E 16A 250V~

- 2P+E schuko double
- 16A 250V~, type VE16
- in accordance with IEC 60884-1, CEE7
- screw contacts 1.5-2.5 mm<sup>2</sup>
- KS shuttered live contacts



VTIČNICA FRANCOŠKA DVOJNA 2P+E 16A 250V~



- VE46PWKS
- VE46IWKS
- VE46ESKS
- VE46NBKS

- 2P+E francoska dvojna
- 16A 250V~, tip VE46
- ustreza IEC 60884-1, CEE7; NF C 61-314, CSN 33 2318; PN-E 93201
- vijajčna pritrditev vodnikov 1,5-2,5 mm<sup>2</sup>
- KS zaščita pred dotikom kontaktov

SOCKET FRENCH DOUBLE 2P+E 16A 250V~

- 2P+E French double
- 16A 250V~, type VE46
- in accordance with IEC 60884-1, CEE7; NF C 61-314, CSN 33 2318; PN-E 93201
- screw contacts 1.5-2.5 mm<sup>2</sup>
- KS shuttered live contacts



VTIČNICA 2P 16A 250V~



- VE30PW
- VE30IW
- VE30ES
- VE30NB

- 2P brez ozemljitvenega kontakta
- 16A 250V~
- ustreza EN 60884-1, CEE7 (list I)
- vijajčna pritrditev vodnikov 1.5-2.5mm<sup>2</sup>

SOCKET 2P 16A 250V~

- 2P without earthing contact
- 16A 250V~
- in accordance with EN 60884-1, CEE7 (standard sheet I)
- screw contacts 1.5-2.5mm<sup>2</sup>

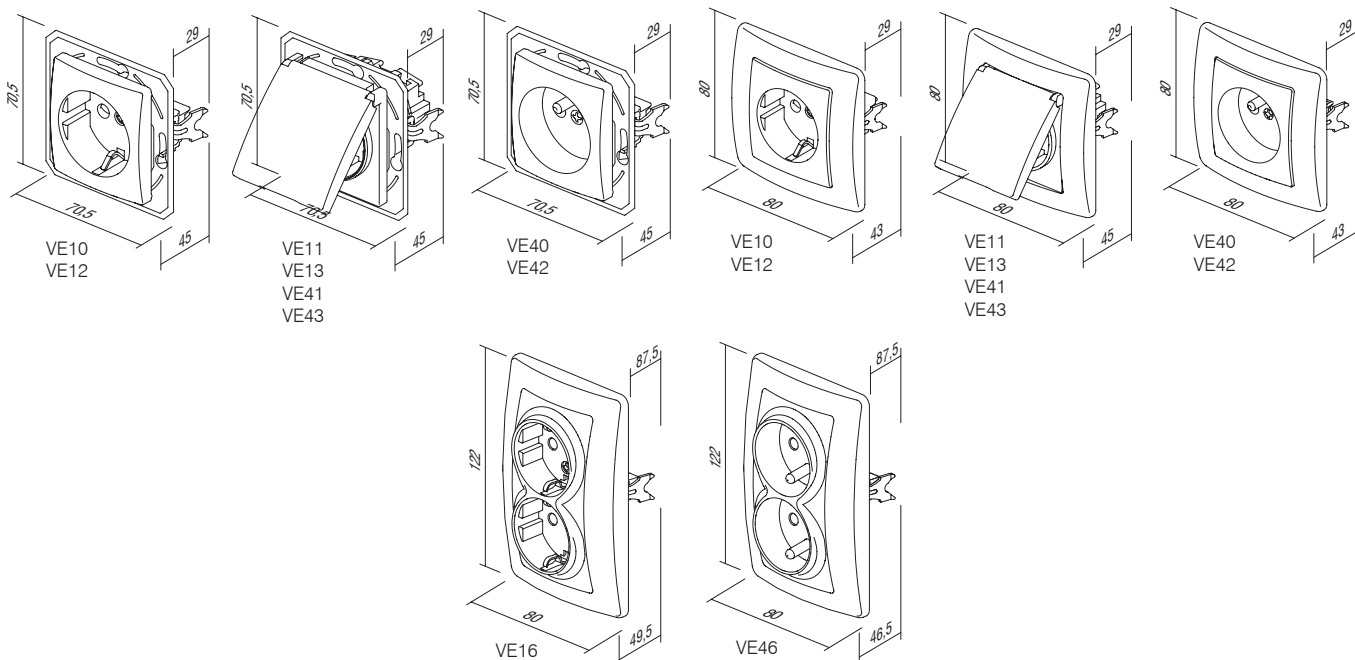



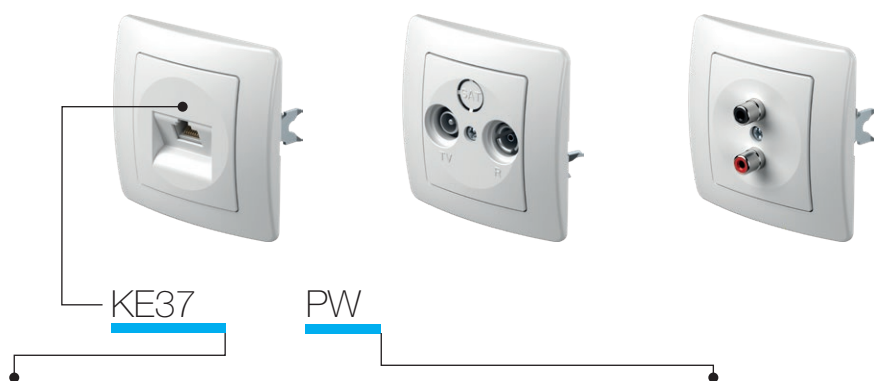

tip type	naziv description	tehnični opis technical data	barva colour
KE11	VTIČNICA TV-R KONČNA SOCKET TV-R END-LINE	1dB	<input type="checkbox"/> PW bela-sijaj polar white
KE12	VTIČNICA TV-R PREHODNA SOCKET TV-R THROUGHPASS	10dB	<input type="checkbox"/> IW bež-sijaj ivory white
KE16	VTIČNICA SAT-TV-R KONČNA SOCKET SAT-TV-R END-LINE	3dB	<input type="checkbox"/> ES srebrna-mat elox silver
⋮	⋮	⋮	<input type="checkbox"/> CO beli duroplast white thermoset
⋮	⋮	⋮	<input type="checkbox"/> NB črna-sijaj night black

## VTIČNICA TV-R KONČNA 1dB



KE11

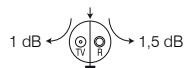

- TV-R končna
- frekvenčni pas 5+862MHz
- dušenje: R-1.5dB, TV-1dB
- ustreza EN 50083-1
- vijačna priključitev

## SOCKET TV-R END-LINE 1dB

- TV-R end-line
- frequency range 5+862MHz
- reduction: R-1.5dB, TV-1dB
- in accordance with EN 50083-1
- screw contacts

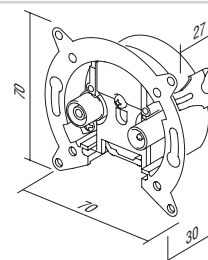

## VTIČNICA TV-R PREHODNA 10dB



KE12

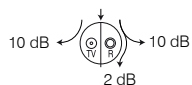

- TV-R prehodna vtičnica
- frekvenčni pas 5+862MHz
- dušenje: R-10dB, TV-10dB, prehod-2dB
- ustreza EN 50083-1
- vijačna priključitev

## SOCKET TV-R THROUGHPASS 10dB

- TV-R throughpass
- frequency range 5+862MHz
- reduction: R-10dB, TV-10dB, through-2dB
- in accordance with EN 50083-1
- screw contacts

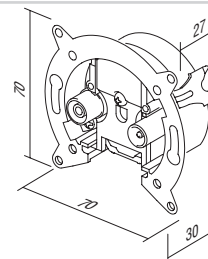

## VTIČNICA SAT-TV-R KONČNA 3dB



KE16

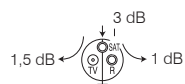

- SAT-TV-R končna
- frekvenčni pas 5+2400MHz
- dušenje: R-1dB, TV-1.5dB, SAT-3dB
- vgradnja v dozo Ø60 s krepeljci ali vijaki
- ustreza EN 50083-1
- vijačna pritrditev vodnikov

## SOCKET SAT-TV-R END-LINE 3dB

- SAT-TV-R end-line
- frequency range 5+2400MHz
- reduction: R-1dB, TV-1.5dB, SAT-3dB
- for mounting in round box Ø60 with claws or screws
- in accordance with EN 50083-1
- screw contacts

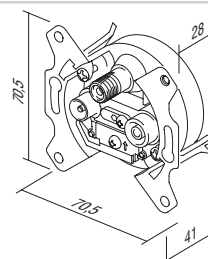

## VTIČNICA TEL KS RJ11 6/4



KE36

- KS keystone pritrditveni standard
- RJ11 6/4
- ustreza IEC 60603-7

## SOCKET TEL KS RJ11 6/4

- KS keystone fixing standard
- RJ11 6/4
- in accordance with IEC 60603-7

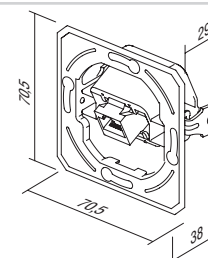



**VTIČNICA CAT5e KS RJ45 8/8**



KE37

- KS keystone pritrditveni standard
- CAT5e, RJ45 8/8
- ustreza IEC 60603-7

**SOCKET CAT5e KS RJ45 8/8**

- KS keystone fixing standard
- CAT5e, RJ45 8/8
- in accordance with IEC 60603-7

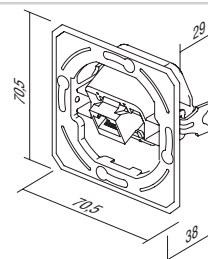

**VTIČNICA CAT6s KS RJ45 8/8 SLIM**



KE40

- KS keystone pritrditveni standard
- CAT6s, RJ45 8/8
- ustreza IEC 60603-7

**SOCKET CAT6s KS RJ45 8/8 SLIM**

- KS keystone fixing standard
- CAT6s, RJ45 8/8
- in accordance with IEC 60603-7

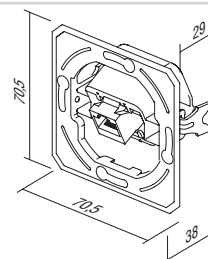

**VTIČNICA TEL KS DVOJNA 2x RJ11 6/4**



KE38

- KS keystone pritrditveni standard
- 2x RJ11 6/4
- ustreza IEC 60603-7

**SOCKET TEL KS DOUBLE 2x RJ11 6/4**

- KS keystone fixing standard
- 2x RJ11 6/4
- in accordance with IEC 60603-7

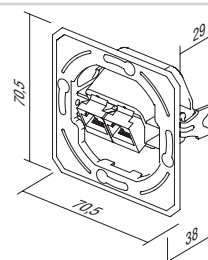

**VTIČNICA CAT5e KS DVOJNA 2x RJ45 8/8**



KE39

- KS keystone pritrditveni standard
- 2x CAT5e, RJ45 8/8
- ustreza IEC 60603-7

**SOCKET CAT5e KS DOUBLE 2x RJ45 8/8**

- KS keystone fixing standard
- 2x CAT5e, RJ45 8/8
- in accordance with IEC 60603-7

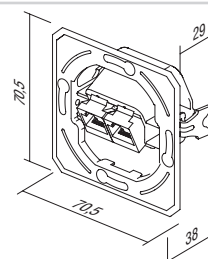

**VTIČNICA CAT6s KS DVOJNA 2x RJ45 8/8 SLIM**



KE41

- KS keystone pritrditveni standard
- 2x CAT6s, RJ45 8/8
- ustreza IEC 60603-7

**SOCKET CAT6s KS DOUBLE 2x RJ45 8/8 SLIM**

- KS keystone fixing standard
- 2x CAT6s, RJ45 8/8
- in accordance with IEC 60603-7

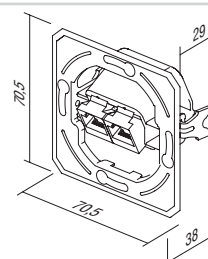

**ADAPTER KS ENOJNI**



KE45

- KS keystone pritrditveni standard - enojni
- AMP, Avaya, Brandrex, FMT, Mfico, Tyco, ...
- komunikacijski modul ni vgrajen

**ADAPTER KS SINGLE**

- KS keystone fixing standard - single
- AMP, Avaya, Brandrex, FMT, Mfico, Tyco, ...
- communication module not included

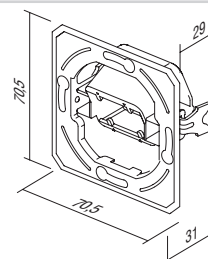



KE46

**ADAPTER KS DVOJNI**

- KS keystone pritrditveni standard - dvojni
- AMP, Tyco, ...
- komunikacijski modul ni vgrajen

**ADAPTER KS DOUBLE**

- KS keystone fixing standard - double
- AMP, Tyco, ...
- communication module not included

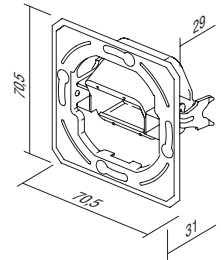

KE47

**ADAPTER PD DVOJNI**

- PD Panduit MiniCOM pritrditveni standard - dvojni
- komunikacijski modul ni vgrajen

**ADAPTER PD DOUBLE**

- PD Panduit Mini-COM fixing standard - double
- communication module not included

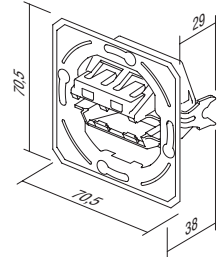

**VTIČNICA TV OSNOVNA 0dB**



- KE10PW
- KE10IW
- KE10ES
- KE10CO
- KE10NB

- TV osnovna
- dušenje 0dB
- konektor zadaj – F standard

**SOCKET TV BASIC 0dB**

- TV basic
- reduction 0dB
- back connector – F standard



**VTIČNICA TV-R KONČNA 1dB**



- KE11PW
- KE11IW
- KE11ES
- KE11CO
- KE11NB

- TV-R končna
- frekvenčni pas 5-862 MHz
- dušenje: R-1.5dB, TV-1dB
- ustreza EN 50083-1
- vijačna priključitev

**SOCKET TV-R END-LINE 1dB**

- TV-R end-line
- frequency range 5-862 MHz
- reduction: R-1.5dB, TV-1dB
- in accordance with EN 50083-1
- screw contact



**VTIČNICA TV-R PREHODNA 10dB**



- KE12PW
- KE12IW
- KE12ES
- KE12CO
- KE12NB

- TV-R prehodna
- frekvenčni pas 5-862 MHz
- dušenje: R-10dB, TV-10dB, prehod-2dB
- ustreza EN 50083-1
- vijačna priključitev

**SOCKET TV-R TROUGHPASS 10dB**

- TV-R troughpass
- frequency range 5-862 MHz
- reduction: R-10dB, TV-10dB, trough-2dB
- in accordance with EN 50083-1
- screw contacts



**VTIČNICA SAT-TV-R KONČNA 3dB**



- KE16PW
- KE16IW
- KE16ES
- KE16CO
- KE16NB

- SAT-TV-R končna
- frekvenčni pas 5-2400 MHz
- dušenje: R-1dB, TV-1.5dB, SAT-3dB
- ustreza EN 50083-1
- vijačna priključitev

**SOCKET SAT-TV-R END-LINE 3dB**

- SAT-TV-R end-line
- frequency range 5-2400 MHz
- reduction: R-1dB, TV-1.5dB, SAT-3dB
- in accordance with EN 50083-1
- screw contacts



**VTIČNICA AVDIO 2xRCA**



- KE22PW
- KE22IW
- KE22ES
- KE22CO
- KE22NB

- avdio 2xRCA
- pritrditve vodnikov s spajkanjem

**SOCKET AUDIO 2xRCA**

- audio 2xRCA
- soldering connection of cable



**VTIČNICA AVDIO ZVOČNIŠKA**



- KE23PW
- KE23IW
- KE23ES
- KE23CO
- KE23NB

- avdio 2x Ø4mm
- za priklop zvočniškega vodnika, vtiča Ø4mm ali viličastega kabel čevlja
- pritrditve vodnikov zadaj s spajkanjem

**SOCKET AUDIO LOUDSPEAKERS**

- audio 2x Ø4mm
- to accommodate speaker wire, banana plug Ø4mm or spades
- soldering connection of cable at the back side



**VTIČNICA TEL KS RJ11 6/4**

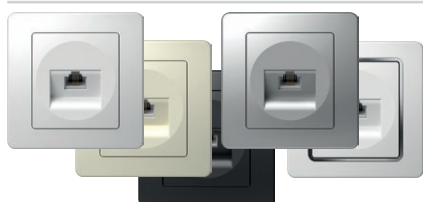

- KE36PW
- KE36IW
- KE36ES
- KE36CO
- KE36NB

- KS keystone pritrditveni standard
- RJ11 6/4
- ustreza IEC 60603-7

**SOCKET TEL KS RJ11 6/4**

- KS keystone fixing standard
- RJ11 6/4
- in accordance with IEC 60603-7



## VTIČNICA CAT5e KS RJ45 8/8



- KE37PW
- KE37IW
- KE37ES
- KE37CO
- KE37NB

- KS keystone pritrditveni standard
- CAT5e, RJ45 8/8
- ustreza IEC 60603-7

## SOCKET CAT5e KS RJ45 8/8

- KS keystone fixing standard
- CAT5e, RJ45 8/8
- in accordance with IEC 60603-7



## VTIČNICA CAT6s KS RJ45 8/8 SLIM

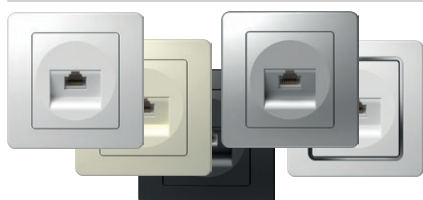

- KE40PW
- KE40IW
- KE40ES
- KE40CO
- KE40NB

- KS keystone pritrditveni standard
- CAT6s, RJ45 8/8
- ustreza IEC 60603-7

## SOCKET CAT6s KS RJ45 8/8 SLIM

- KS keystone fixing standard
- CAT6s, RJ45 8/8
- in accordance with IEC 60603-7



## VTIČNICA TEL KS DVOJNA 2x RJ11 6/4

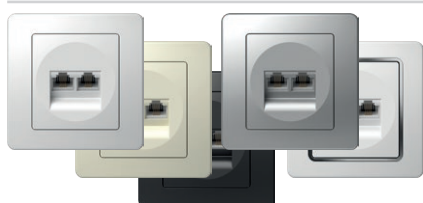

- KE38PW
- KE38IW
- KE38ES
- KE38CO
- KE38NB

- KS keystone pritrditveni standard
- 2x RJ11, 6/4
- ustreza IEC 60603-7

## SOCKET TEL KS DOUBLE 2x RJ11 6/4

- KS keystone fixing standard
- 2x RJ11, 6/4
- in accordance with IEC 60603-7



## VTIČNICA CAT5e KS DVOJNA 2x RJ45 8/8



- KE39PW
- KE39IW
- KE39ES
- KE39CO
- KE39NB

- KS keystone pritrditveni standard
- 2x CAT5e, RJ45 8/8
- ustreza IEC 60603-7

## SOCKET CAT5e KS DOUBLE 2x RJ45 8/8

- KS keystone fixing standard
- 2x CAT5e, RJ45 8/8
- in accordance with IEC 60603-7



## VTIČNICA CAT6s KS DVOJNA 2x RJ45 8/8 SLIM



- KE41PW
- KE41IW
- KE41ES
- KE41CO
- KE41NB

- KS keystone pritrditveni standard
- 2x CAT6s, RJ45 8/8
- ustreza IEC 60603-7

## SOCKET CAT6s KS DOUBLE 2x RJ45 8/8 SLIM

- KS keystone fixing standard
- 2x CAT6s, RJ45 8/8
- in accordance with IEC 60603-7



## VTIČNICA TEL LT RJ11 6/4



- KE35PW
- KE35IW
- KE35ES
- KE35CO
- KE35NB

- TEL LT vijak
- vijačna pritrditvev vodnikov
- RJ11 6/4
- ustreza IEC 60603-7

## SOCKET TEL LT RJ11 6/4

- TEL LT screw
- screw contacts
- RJ11 6/4
- in accordance with IEC 60603-7

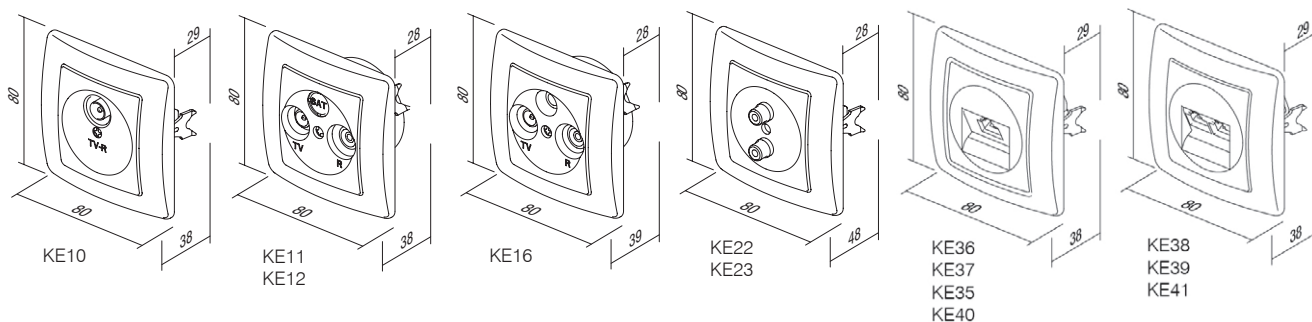





PE20

PW

tip type	naziv description	tehnični opis technical data	barva colour
PE10	POKROV TV-R COVER TV-R	2P/3P	<input type="checkbox"/> PW bela-sijaj polar white
PE20	POKROV KS ENOJNI COVER KS SINGLE		<input type="checkbox"/> IW bež-sijaj ivory white
PE21	POKROV KS DVOJNI COVER KS DOUBLE		<input type="checkbox"/> ES srebrna-mat elox silver
⋮	⋮	⋮	<input type="checkbox"/> CO beli duroplast white thermoset
			<input type="checkbox"/> NB črna-sijaj night black

**POKROV TV-R 2P/3P**



- PE10PW
- PE10IW
- PE10ES
- PE10CO
- PE10NB

- TV-R pokrov, 2P ali 3P z vijakom  
COVER TV-R 2P/3P  
- TV-R cover, 2P or 3P with screw



**POKROV KS ENOJNI**

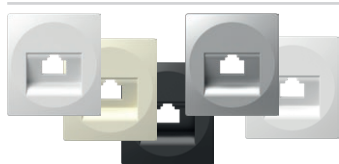

- PE20PW
- PE20IW
- PE20ES
- PE20CO
- PE20NB

- KS pokrov enojni  
COVER KS SINGLE  
- KS cover single



**POKROV KS DVOJNI**

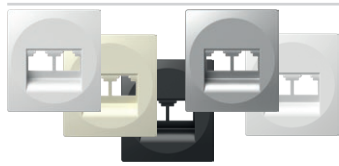

- PE21PW
- PE21IW
- PE21ES
- PE21NB

- KS pokrov dvojni  
COVER KS DOUBLE  
- KS cover double



**POKROV TAE/TDO**



- PE30PW
- PE30IW
- PE30ES
- PE30NB

- TAE ali TDO pokrov z vijakom  
COVER TAE/TDO  
- TAE or TDO cover with screw



**POKROV IR STIKALO**



- PE32PW
- PE32IW
- PE32ES
- PE32NB

- pokrov IR stikalo  
COVER IR SWITCH  
- cover IR switch

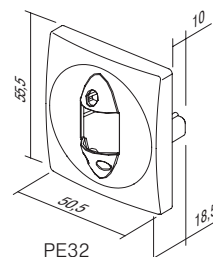
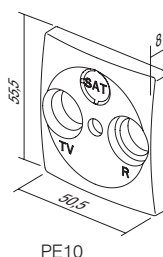
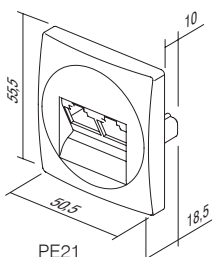
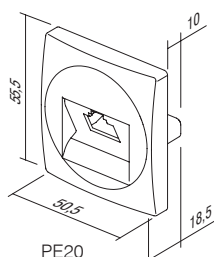
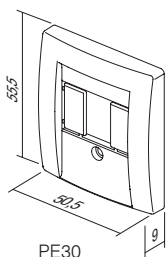

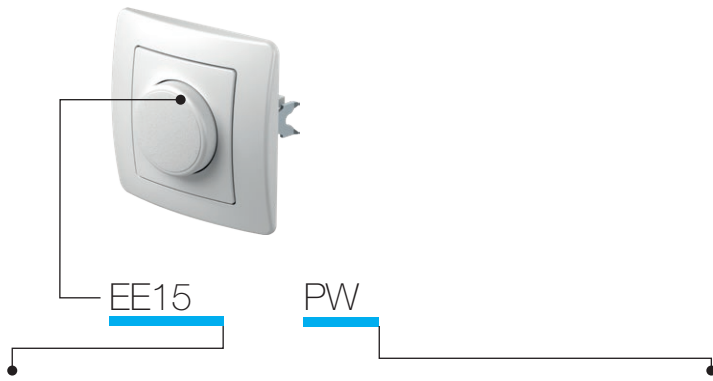

tip type	naziv description	tehnični opis technical data	barva colour
EE15	ZATEMNILNIK ROTACIJSKI MEN DIMMER ROTATIVE 2WAY	RL 400W	<input type="checkbox"/> PW bela-sijaj polar white
EE16	ZATEMNILNIK ROTACIJSKI MEN DIMMER ROTATIVE 2WAY	RLC 400W	<input type="checkbox"/> IW bež-sijaj ivory white
EE19	ZATEMNILNIK ROTACIJSKI MEN DIMMER ROTATIVE 2WAY	LED 100W	<input type="checkbox"/> ES srebrna-mat elox silver
⋮	⋮	⋮	<input type="checkbox"/> CO beli duroplast white thermoset
⋮	⋮	⋮	<input type="checkbox"/> NB črna-sijaj night black

#### ZATEMNILNIK ROTACIJSKI MEN RL 400W



EE15

- rotacijski z menjalnim stikalom
- breme RL, 40W - 400W
- možna vezava z menjalnim stikalom
- vezava večih zatemnilnikov ni dovoljena
- ustreza EN 60669-1 in EN 60669-2-1
- brezvijačna pritrditev vodnikov 1.5mm<sup>2</sup>
- napajanje 230V~ 50Hz
- premer nastavka gumba Ø6mm
- zamenljiva varovalka vključena

#### DIMMER ROTATIVE 2WAY RL 400W

- rotation control with 2-way switch
- load RL, 40W - 400W
- 2-way switch combination is possible
- more dimmers combination is not allowed
- in accordance with EN 60669-1 and EN 60669-2-1
- plug-in contacts 1.5mm<sup>2</sup>
- supply 230V~ 50Hz
- button inner diameter Ø6mm
- replaceable fuse included

#### ZATEMNILNIK ROTACIJSKI MEN RLC 400W



EE16

- rotacijski z menjalnim stikalom
- breme RLC, 20W - 400W
- možna vezava z menjalnim stikalom
- vezava večih zatemnilnikov ni dovoljena
- ustreza EN 60669-1 in EN 60669-2-1
- brezvijačna pritrditev vodnikov 1.5mm<sup>2</sup>
- napajanje 230V~ 50Hz
- premer nastavka gumba Ø6mm
- elektronska varovalka

#### DIMMER ROTATIVE 2WAY RLC 400W

- rotation control with 2-way switch
- load RLC, 20W - 400W
- 2-way switch combination is possible
- more dimmers combination is not allowed
- in accordance with EN 60669-1 and EN 60669-2-1
- plug-in contacts 1.5mm<sup>2</sup>
- supply 230V~ 50Hz
- button inner diameter Ø6mm
- electronic fuse



EE19

### ZATEMNILNIK ROTACIJSKI MEN LED 100W

- rotacijski z menjalnim stikalom
- breme: LED, 0-100W (max. 10 LED sijalk)  
GLS, 10-250W
- možna vezava z menjalnim stikalom
- vezava več zatemnilnikov ni dovoljena
- ustreza EN 60669-1 in EN 60669-2-1
- brezvijačna pritrditev vodnikov 1,5 mm<sup>2</sup>
- napajanje 230V~ 50 Hz
- zamenljiva varovalka vključena
- premer nastavka gumba Ø6mm

#### DIMMER ROTATIVE 2WAY LED 100W

- rotation control with 2-way switch
- load: LED, 0-100W (max. 10 LEDs)  
GLS, 10-250W
- 2-way switch combination is possible
- more dimmers combination is not allowed
- in accordance with EN 60669-1 and EN 60669-2-1
- plug-in contacts 1.5mm<sup>2</sup>
- supply 230V~ 50Hz
- replaceable fuse included
- button inner diameter Ø6mm

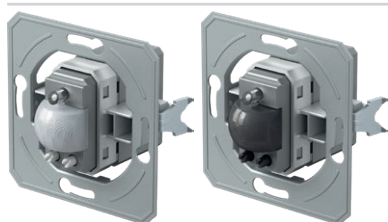

- EE32A1
- EE32A2

### IR STIKALO 5A 230V~

- IR infrardeče stikalo
- napajanje: 230V~ ±10 % 50Hz
- rele: 5A / 250V~ izhod za omejen tok z visokim uporom za zero crossing
- stopnja varnosti: IP40
- presek žic pri stičniku: 0,75 - 2,5 mm<sup>2</sup>
- kot zaznavanja: do 110° pri 20°C
- območje zaznavanja: približno 8 m pri 20°C
- nastavljivost časovnega trajanja: od približno 5 s do 12 min
- nastavljivost osvetlitve: od približno 5 do 200 LUX
- temperatura delovanja: od 0°C do +40°C
- ni primeren za vgradnjo v doze, globine 45 mm
- samo za notranjo uporabo

#### IR SWITCH 5A 230V~

- IR infrared switch
- supply voltage: 230V~ ±10 % 50Hz
- relay: 5A / 250V~ output for limited current with high resistance for zero crossing
- protection rating: IP40
- cross-section of wires at the contact terminal: 0.75 - 2.5 mm<sup>2</sup>
- detection angle: up to 110° at 20°C
- detection area: approx. 8 m at 20°C
- adjustability of duration: from approx. 5 s to 12 min
- adjustability of brightness: from approx. 5 to 200 LUX
- operating temperature: from 0°C to +40°C
- not suitable for installation in 45 mm deep boxes
- only for indoor usage



- EE15PW
- EE15IW
- EE15ES
- EE15CO
- EE15NB

### ZATEMNILNIK ROTACIJSKI MEN RL 400W

- rotacijski z menjalnim stikalom
- breme RL, 40W - 400W
- možna vezava z menjalnim stikalom
- vezava večih zatemnilnikov ni dovoljena
- ustreza EN 60669-1 in EN 60669-2-1
- brezvijačna pritrditev vodnikov 1.5mm<sup>2</sup>
- napajanje 230V~ 50Hz
- zamenljiva varovalka vključena

#### DIMMER ROTATIVE 2WAY RL 400W

- rotation control with 2-way switch
- load RL, 40W - 400W
- 2-way switch combination is possible
- more dimmers combination is not allowed
- in accordance with EN 60669-1 and EN 60669-2-1
- plug-in contacts 1.5mm<sup>2</sup>
- supply 230V~ 50Hz
- replaceable fuse included



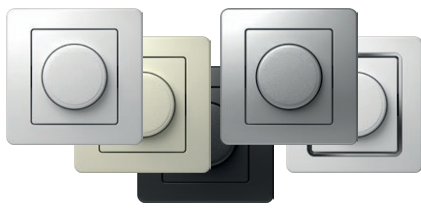

- EE16PW
- EE16IW
- EE16ES
- EE16CO
- EE16NB

#### ZATEMNILNIK ROTACIJSKI MEN RLC 400W

- rotacijski z menjalnim stikalom
- breme RLC, 20W - 400W
- možna vezava z menjalnim stikalom
- vezava večih zatemnilnikov ni dovoljena
- ustreza EN 60669-1 in EN 60669-2-1
- brezvijačna pritrditev vodnikov 1.5mm<sup>2</sup>
- napajanje 230V~ 50Hz
- elektronska varovalka

#### DIMMER ROTATIVE 2WAY RLC 400W

- rotation control with 2-way switch
- load RLC, 20W - 400W
- 2-way switch combination is possible
- more dimmers combination is not allowed
- in accordance with EN 60669-1 and EN 60669-2-1
- plug-in contacts 1.5mm<sup>2</sup>
- supply 230V~ 50Hz
- electronic fuse



- EE19PW
- EE19IW
- EE19ES
- EE19CO
- EE19NB

#### ZATEMNILNIK ROTACIJSKI MEN LED 100W

- rotacijski z menjalnim stikalom
- breme: LED, 0-100W (max. 10 LED sijalk)
- GLS, 10-250W
- možna vezava z menjalnim stikalom
- vezava več zatemnilnikov ni dovoljena
- ustreza EN 60669-1 in EN 60669-2-1
- brezvijačna pritrditev vodnikov 1,5 mm<sup>2</sup>
- napajanje 230V~ 50 Hz
- zamenljiva varovalka vključena

#### DIMMER ROTATIVE 2WAY LED 100W

- rotation control with 2-way switch
- load: LED, 0-100W (max. 10 LEDs)
- GLS, 10-250W
- 2-way switch combination is possible
- more dimmers combination is not allowed
- in accordance with EN 60669-1 and EN 60669-2-1
- plug-in contacts 1.5mm<sup>2</sup>
- supply 230V~ 50Hz
- replaceable fuse included



- EE32PW
- EE32IW
- EE32ES
- EE32CO
- EE32NB

#### IR STIKALO 5A 230V~

- IR infrardeče stikalo
- napajanje: 230V~ ±10 % 50Hz
- rele: 5A / 250V~ izhod za omejen tok z visokim uporom za zero crossing
- stopnja varnosti: IP40
- presek žic pri stičniku: 0,75 - 2,5 mm<sup>2</sup>
- kot zaznavanja: do 110° pri 20°C
- območje zaznavanja: približno 8 m pri 20°C
- nastavitivost časovnega trajanja: od približno 5 s do 12 min
- nastavitivost osvetlitve: od približno 5 do 200 LUX
- temperatura delovanja: od 0°C do +40°C
- ni primeren za vgradnjo v doze, globine 45 mm
- samo za notranjo uporabo

#### IR SWITCH 5A 230V~

- IR infrared switch
- supply voltage: 230V~ ±10 % 50Hz
- relay: 5A / 250V~ output for limited current with high resistance for zero crossing
- protection rating: IP40
- cross-section of wires at the contact terminal: 0.75 - 2.5 mm<sup>2</sup>
- detection angle: up to 110° at 20°C
- detection area: approx. 8 m at 20°C
- adjustability of duration: from approx. 5 s to 12 min
- adjustability of brightness: from approx. 5 to 200 LUX
- operating temperature: from 0°C to +40°C
- not suitable for installation in 45 mm deep boxes
- only for indoor usage





EE15, EE16, EE19

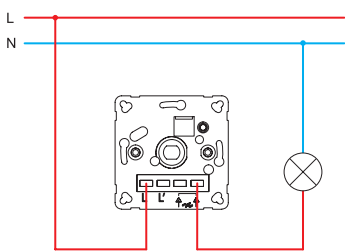

EE15, EE16, EE19

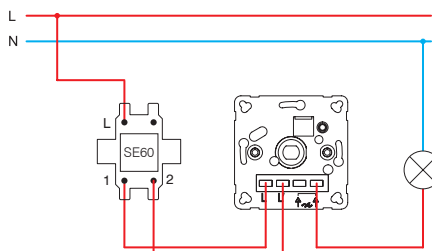

EE15, EE16, EE19

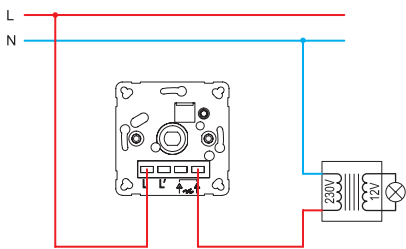

EE15, EE16, EE19

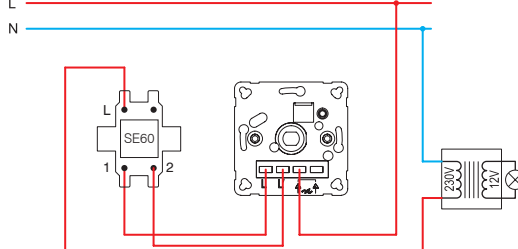

EE16, EE19

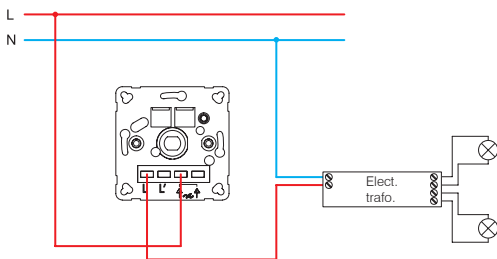

EE16, EE19

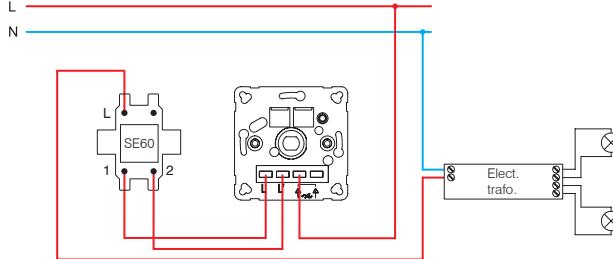

ekonomik

**EE15 (40÷400W)**

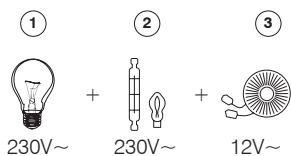

- 1 - žarnica z žarilno nitko / incandescent lamp
- 2 - halogenska žarnica / halogen lamp

**EE16 (20÷400W)**

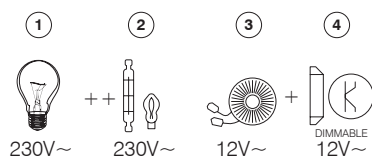

- 3 - klasični transformator / classical transformer
- 4 - zatemnilni elektronski transformator / dimmable electronic transformer

**EE19 (GLS 10÷250W ; LED 0÷100W)**

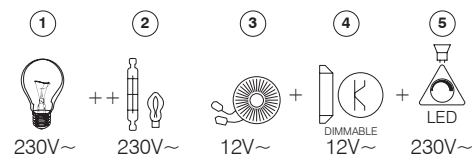

- 5 - zatemnilna LED sijalka / dimmable LED lamp

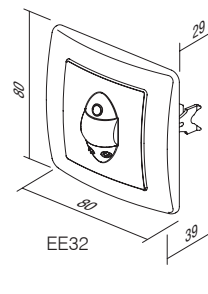
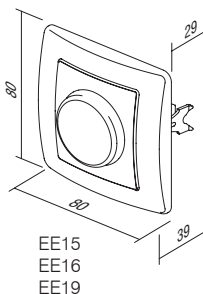
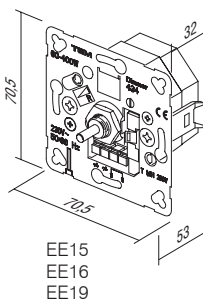

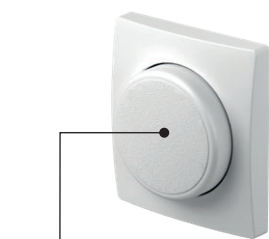

PE41

PW

tip type	naziv description	barva colour
PE41	POKROV ZATEMNILNO STIKALO COVER DIMMER	<input type="checkbox"/> PW bela-sijaj <i>polar white</i> <input type="checkbox"/> IW bež-sijaj <i>ivory white</i> <input type="checkbox"/> ES srebrna-mat <i>elox silver</i> <input type="checkbox"/> CO beli duroplast <i>white thermoset</i> <input type="checkbox"/> NB črna-sijaj <i>night black</i>



- PE41PW
- PE41IW
- PE41ES
- PE41CO
- PE41NB

## POKROV ZATEMNILNO STIKALO Ø6

- pokrov zatemnilno stikalo Ø6mm  
- za EE15, EE16, EE19

## COVER DIMMER Ø6

- cover dimmer Ø6mm  
- for EE15, EE16, EE19

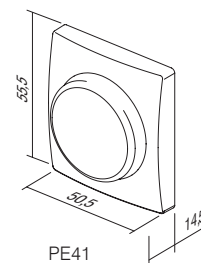

PE41

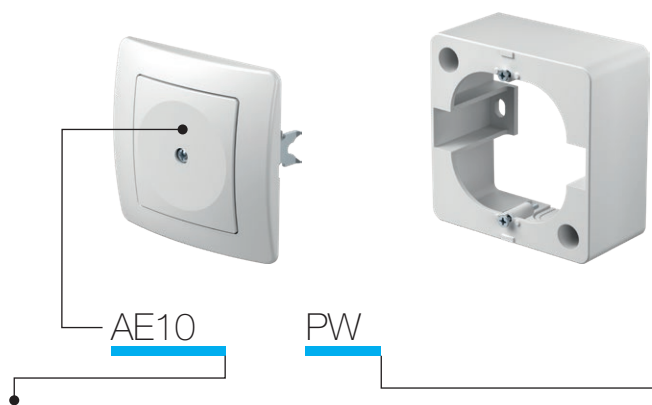

tip type	naziv description	barva colour
AE10	POLNILO BLANK	<input type="checkbox"/> PW bela-sijaj polar white
AE20	PRIKLJUČEK PETPOLNI STALNI 3P+N+E 5X4mm <sup>2</sup> CONNECTION BOX 3P+N+E 5X4mm <sup>2</sup>	<input type="checkbox"/> IW bež-sijaj ivory white
AE30	OHIŠJE NO 1 SURFACE MOUNT BOX	<input type="checkbox"/> ES srebrna-mat elox silver
:	:	<input type="checkbox"/> CO beli duroplast white thermoset
:	:	<input type="checkbox"/> NB črna-sijaj night black

**POLNILO**



- AE10PW
- AE10IW
- AE10ES
- AE10CO
- AE10NB

- za pokrivanje praznih odprtin  
**BLANK**  
- for filling up empty spaces



**PRIKLJUČEK PETPOLNI STALNI 3P+N+E 5x4mm<sup>2</sup>**



- AE20PW
- AE20IW

- 3P+N+E stalni priključek  
- 16A 400V  
- ustreza VDE 0601-1:2000  
- vijajčna pritrditev vodnikov 1.5-4mm<sup>2</sup>  
**CONNECTION BOX 5POLE 3P+N+E 5x4mm<sup>2</sup>**  
- 3P+N+E connection box  
- 16A 400V  
- in accordance with VDE 0606-1:2000  
- screw contacts 1.5-4mm<sup>2</sup>



**OHIŠJE NADOMETNO 1**

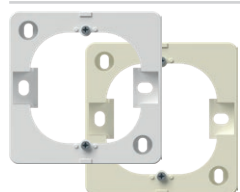

- AE30PW
- AE30IW

- nadometno ohišje  
**SURFACE MOUNT BOX 1**  
- surface mounting box



**OHIŠJE NADOMETNO ZA DVOJNO VTIČNICO EKONOMIK**

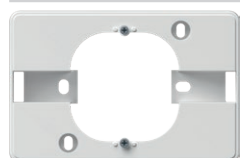

- AE31PW

- nadometno ohišje  
**SURFACE MOUNT BOX FOR EKONOMIK DOUBLE SOCKET**  
- surface mounting box





- AE50PW
- AE50TS

#### STENSKI ŠČITNIK

- ščitnik stene okoli stikala ali vtičnice

#### WALL PROTECTION

- protects surface around socket or switch

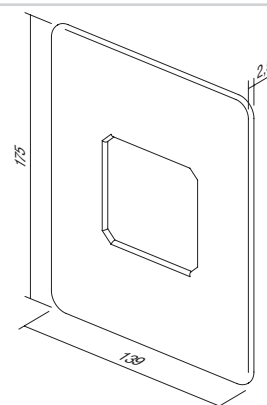

- AE51PW
- AE51IW

#### OTROŠKA ZAŠČITA KS

- KS otroška zaščita pred dotikom kontaktov

#### CHILD PROTECTION KS

- KS additional child protection insert - shuttered live contacts

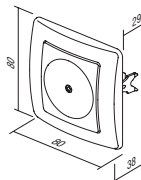
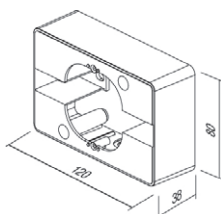
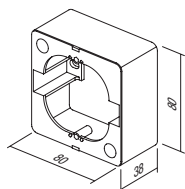
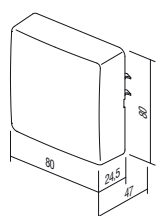
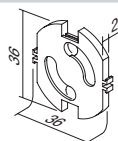



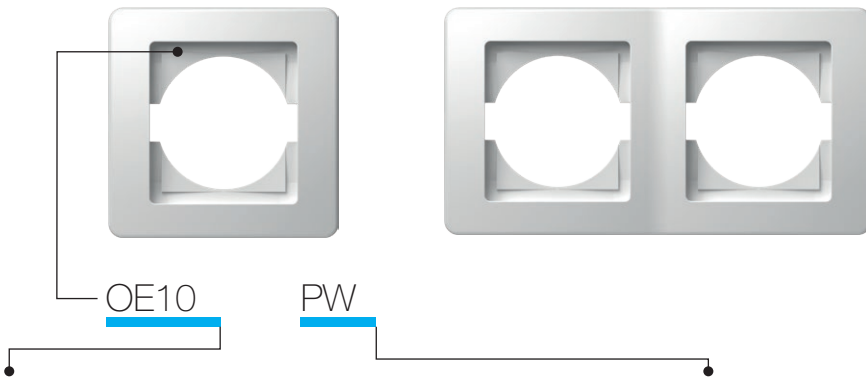

tip type	naziv description	barva colour
OE10	OKVIR EKONOMIK 1 SURROUND EKONOMIK 1	<input type="checkbox"/> PW bela-sijaj polar white
OE20	OKVIR EKONOMIK 2 HORIZONTALNI SURROUND EKONOMIK 2 HORIZONTAL	<input type="checkbox"/> IW bež-sijaj ivory white
OE30	OKVIR EKONOMIK 3 HORIZONTALNI SURROUND EKONOMIK 3 HORIZONTAL	<input type="checkbox"/> ES srebrna-mat elox silver
⋮	⋮	<input type="checkbox"/> CO beli duroplast white thermoset
⋮	⋮	<input type="checkbox"/> NB črna-sijaj night black



- OE10PW
- OE10IW
- OE10ES
- OE10CO
- OE10NB

**OKVIR EKONOMIK 1**

- dekorativni enojni okvir  
- ustreza EN 60669-1  
**SURROUND EKONOMIK 1**  
- decorative surround 1-gang  
- in accordance with EN 60669-1

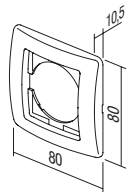

- OE20PW
- OE20IW
- OE20ES
- OE20CO
- OE20NB

**OKVIR EKONOMIK 2 HORIZONTALNI**

- dekorativni dvojni horizontalni okvir  
- ustreza EN 60669-1  
**SURROUND EKONOMIK 2 HORIZONTAL**  
- decorative surround 2-gang horizontal  
- in accordance with EN 60669-1

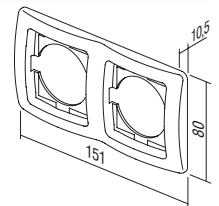

- OE21PW
- OE21IW
- OE21ES
- OE21CO
- OE21NB

**OKVIR EKONOMIK 2 VERTIKALNI**

- dekorativni dvojni vertikalni okvir  
- ustreza EN 60669-1  
**SURROUND EKONOMIK 2 VERTICAL**  
- decorative surround 2-gang vertical  
- in accordance with EN 60669-1

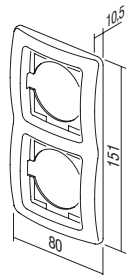

- OE30PW
- OE30IW
- OE30ES
- OE30CO
- OE30NB

**OKVIR EKONOMIK 3 HORIZONTALNI**

- dekorativni trojni horizontalni okvir  
- ustreza EN 60669-1  
**SURROUND EKONOMIK 3 HORIZONTAL**  
- decorative surround 3-gang horizontal  
- in accordance with EN 60669-1

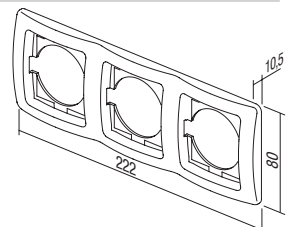



- OE31PW
- OE31IW
- OE31ES
- OE31CO
- OE31NB

#### OKVIR EKONOMIK 3 VERTIKALNI

- dekorativni trojni vertikalni okvir  
- ustreza EN 60669-1

#### SURROUND EKONOMIK 3 VERTICAL

- decorative surround 3-gang vertical  
- in accordance with EN 60669-1

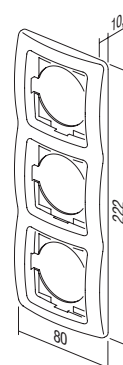

- OE40PW
- OE40IW
- OE40ES
- OE40NB

#### OKVIR EKONOMIK 4 HORIZONTALNI

- dekorativni četvorni horizontalni okvir  
- ustreza EN 60669-1

#### SURROUND EKONOMIK 4 HORIZONTAL

- decorative surround 4-gang horizontal  
- in accordance with EN 60669-1

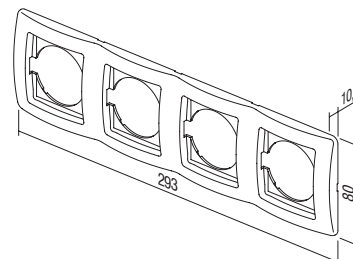

- OE41PW
- OE41IW
- OE41ES
- OE41NB

#### OKVIR EKONOMIK 4 VERTIKALNI

- dekorativni četvorni vertikalni okvir  
- ustreza EN 60669-1

#### SURROUND EKONOMIK 4 VERTICAL

- decorative surround 4-gang vertical  
- in accordance with EN 60669-1

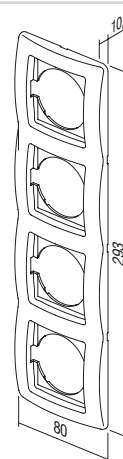

- OE50PW
- OE50IW
- OE50ES
- OE50NB

#### OKVIR EKONOMIK 5 HORIZONTALNI

- dekorativni 5-mestni horizontalni okvir  
- ustreza EN 60669-1

#### SURROUND EKONOMIK 5 HORIZONTAL

- decorative surround 5-gang horizontal  
- in accordance with EN 60669-1

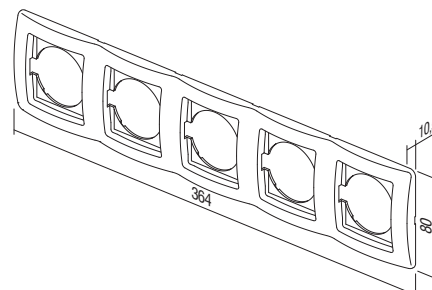

DEKORATIVNI OKVIRČKI COLOR /  
 COLOR DECORATIVE FRAMES



OE90GR	ZELENA / GREEN	OE90YL	RUMENA / YELLOW	OE90MB	MET. MODRA / MET. BLUE
OE90BL	MODRA / BLUE	OE90WH	BELA / WHITE	OE90BZ	BRON / BRONZE
OE90VO	VIJOLA / VIOLET	OE90GY	SIVA / GREY	OE90CR	SREBRNA / SILVER
OE90PI	ROZA / PINK	OE90BK	ČRNA / BLACK	OE90GO	ZLATA / GOLD
OE90RD	RDEČA / RED				







TEM



KATALOG / CATALOGUE

fontana



STIKALA SF  
SWITCHES SF



218

VTIČNICE VF  
SOCKETS VF



220

SETI CF  
SETS CF



221

PRIBOR AF  
ACCESSORIES AF



223

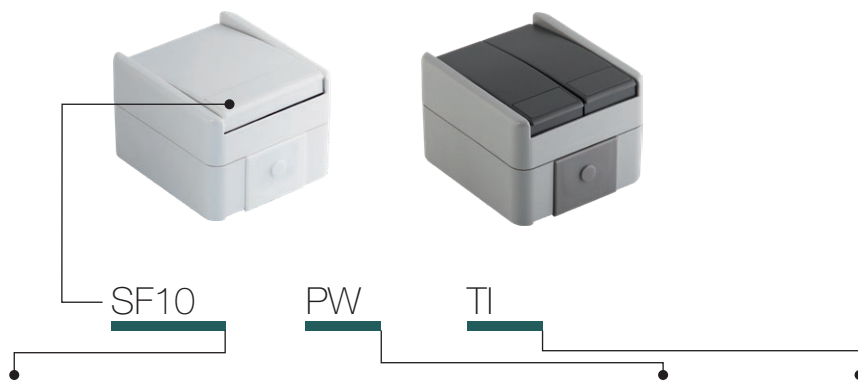

tip type	naziv description	tehnični opis technical data	barva colour	opsijski opis 1 optional data 1
SF10	STIKALO ENOPOLNO SWITCH 1WAY	IP44 10AX 250V~	<input type="checkbox"/> PW bela-mat white-mat	TI tlivka+indikator neon lamp+indication
SF11	TIPKALO ENOPOLNO PUSH BUTTON 1WAY	IP44 10A 250V~	<input checked="" type="checkbox"/> GY siva-mat grey-mat	
SF20	STIKALO DVOPOLNO SWITCH 2POLE	IP44 10AX 250V~		
:	:	:		
:	:	:		

STIKALO ENOPOLNO IP44 10AX 250V~



- SF10PW
- SF10GY

- 10AX 250V~, tip SF10  
- ustreza EN 60669-1  
- brezvijačna pritrditev vodnikov 1.5-2.5mm<sup>2</sup>  
*SWITCH 1WAY IP44 10AX 250V~*  
- 10AX 250V~, type SF10  
- in accordance with EN 60669-1  
- plug-in contacts 1.5-2.5mm<sup>2</sup>



STIKALO ENOPOLNO IP44 10AX 250V~ \_\_ TI



- SF10PWTI
- SF10GYTI

- TI indikator+tlivka  
- 10AX 250V~, tip SF10  
- ustreza EN 60669-1  
- brezvijačna pritrditev vodnikov 1.5-2.5mm<sup>2</sup>  
*SWITCH 1WAY IP44 10AX 250V~ \_\_ TI*  
- TI indicator+neon lamp  
- 10AX 250V~, type SF10  
- in accordance with EN 60669-1  
- plug-in contacts 1.5-2.5mm<sup>2</sup>



TIPKALO ENOPOLNO IP44 10A 250V~ \_\_ TI



- SF11PWTI
- SF11GYTI

- TI indikator+tlivka  
- 10A 250V~, tip SF11  
- ustreza EN 60669-1  
- brezvijačna pritrditev vodnikov 1.5-2.5mm<sup>2</sup>  
*PUSH BUTTON 1WAY IP44 10A 250V~ \_\_ TI*  
- TI indicator+neon lamp  
- 10A 250V~, type SF11  
- in accordance with EN 60669-1  
- plug-in contacts 1.5-2.5mm<sup>2</sup>



STIKALO DVOPOLNO IP44 10AX 250V~



- SF20PW
- SF20GY

- 10AX 250V~, tip SF20  
- ustreza EN 60669-1  
- brezvijačna pritrditev vodnikov 1.5-2.5mm<sup>2</sup>  
*SWITCH 2POLE IP44 10AX 250V~*  
- 10AX 250V~, type SF20  
- in accordance with EN 60669-1  
- plug-in contacts 1.5-2.5mm<sup>2</sup>





- SF50PW
- SF50GY

#### STIKALO SERIJSKO IP44 10AX 250V~

- 10AX 250V~, tip SF50
- ustreza EN 60669-1
- brezvijačna pritrnitev vodnikov 1.5-2.5mm<sup>2</sup>

#### SWITCH 2GANG-1WAY IP44 10AX 250V~

- 10AX 250V~, type SF50
- in accordance with EN 60669-1
- plug-in contacts 1.5-2.5mm<sup>2</sup>



- SF51PW
- SF51GY

#### TIPKALO SERIJSKO IP44 10A 250V~

- 10A 250V~, tip SF51
- ustreza EN 60669-1
- brezvijačna pritrnitev vodnikov 1.5-2.5mm<sup>2</sup>

#### PUSH BUTTON 2GANG-1WAY IP44 10A 250V~

- 10A 250V~, type SF51
- in accordance with EN 60669-1
- plug-in contacts 1.5-2.5mm<sup>2</sup>



- SF60PW
- SF60GY

#### STIKALO MENJALNO IP44 10AX 250V~

- 10AX 250V~, tip SF60
- ustreza EN 60669-1
- brezvijačna pritrnitev vodnikov 1.5-2.5mm<sup>2</sup>

#### SWITCH 2WAY IP44 10AX 250V~

- 10AX 250V~, type SF60
- in accordance with EN 60669-1
- plug-in contacts 1.5-2.5mm<sup>2</sup>



- SF60PWTI
- SF60GYTI

#### STIKALO MENJALNO IP44 10AX 250V~ \_\_ TI

- TI indikator+tlivka
- 10AX 250V~, tip SF60
- ustreza EN 60669-1
- brezvijačna pritrnitev vodnikov 1.5-2.5mm<sup>2</sup>

#### SWITCH 2WAY IP44 10AX 250V~ \_\_ TI

- TI indikator+neon lamp
- 10AX 250V~, type SF60
- in accordance with EN 60669-1
- plug-in contacts 1.5-2.5mm<sup>2</sup>



- SF63PW
- SF63GY

#### STIKALO DVOJNO MENJALNO IP44 10AX 250V~

- 10AX 250V~, tip SF63
- ustreza EN 60669-1
- brezvijačna pritrnitev vodnikov 1.5-2.5mm<sup>2</sup>

#### SWITCH 2WAY DOUBLE IP44 10AX 250V~

- 10AX 250V~, type SF63
- in accordance with EN 60669-1
- plug-in contacts 1.5-2.5mm<sup>2</sup>



- SF70PW
- SF70GY

#### STIKALO KRIŽNO IP44 10AX 250V~

- 10AX 250V~, tip SF70
- ustreza EN 60669-1
- brezvijačna pritrnitev vodnikov 1.5-2.5mm<sup>2</sup>

#### SWITCH INTERMEDIATE IP44 10AX 250V~

- 10AX 250V~, type SF70
- in accordance with EN 60669-1
- plug-in contacts 1.5-2.5mm<sup>2</sup>

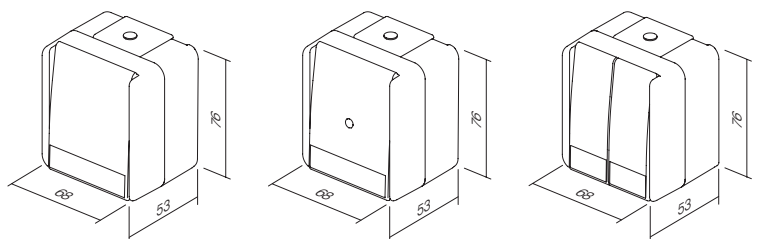

V T I Č N I C E V F  
S O C K E T S

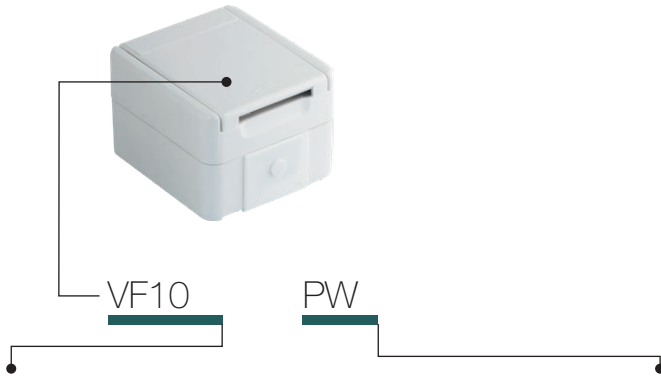

tip type	naziv description	tehnični opis technical data	barva colour
VF10	VTIČNICA SCHUKO+POKROV SOCKET SCHUKO+COVER	IP44 2P+E 16A 250V~	<input type="checkbox"/> PW bela-mat white-mat  <input type="checkbox"/> GY siva-mat grey-mat



- VF10PW
- VF10GY

VTIČNICA SCHUKO+POKROV IP44 2P+E 16A 250V~

- vijajčna pritrditev vodnikov 1.5-2.5mm<sup>2</sup>
- 2P+E schuko+pokrov
- 16A 250V~, tip VF10
- ustreza EN 60884-1, CEE7

SOCKET SCHUKO+COVER IP44 2P+E 16A 250V~

- screw contacts 1.5-2.5mm<sup>2</sup>
- 2P+E schuko+cover
- 16A 250V~, type VF10
- in accordance with EN 60884-1, CEE7



- VF12PW
- VF12GY

VTIČNICA SCHUKO+POKROV IP44 2P+E 16A 250V~ BV

- BV brezvijačna pritrditev vodnikov 1.5-2.5mm<sup>2</sup>
- 2P+E schuko+pokrov
- 16A 250V~, tip VF12
- ustreza EN 60884-1, CEE7

SOCKET SCHUKO+COVER IP44 2P+E 16A 250V~ BV

- BV plug-in contacts 1.5-2.5mm<sup>2</sup>
- 2P+E schuko+cover
- 16A 250V~, type VF12
- in accordance with EN 60884-1, CEE7

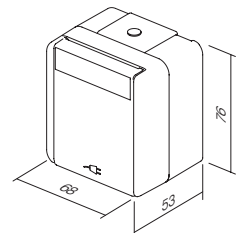

SF10  
SF60



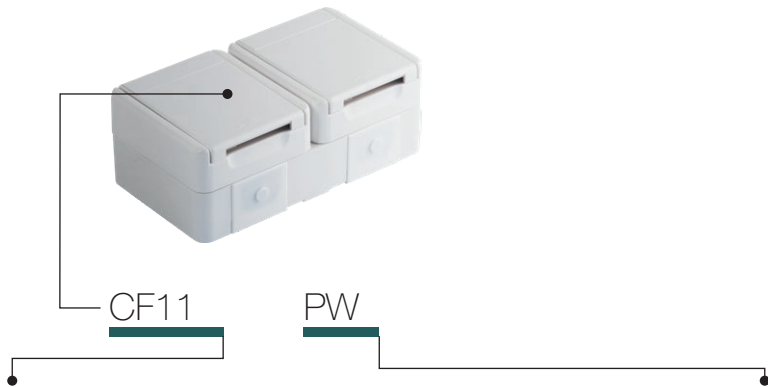

tip type	naziv description	tehnični opis technical data	barva colour
CF10	SET VTIČNICA SCHUKO DVOJNA HORIZ SOCKET SET SCHUKO DOUBLE HORIZ	2x 2P+E 16A 250V~ IP44	<input type="checkbox"/> PW bela-mat white-mat
CF11	SET VTIČNICA SCHUKO DVOJNA VERT SOCKET SET SCHUKO DOUBLE VERT	2x 2P+E 16A 250V~ IP44	<input checked="" type="checkbox"/> GY siva-mat grey-mat
CF12	SET VTIČNICA SCH + STIKALO MEN HORIZ SOCKET SCH+SWITCH 2WAY HORIZ	16A + 10A 250V~ IP44	
⋮	⋮	⋮	
⋮	⋮	⋮	



- CF10PW  
 CF10GY

#### SET VTIČNICA SCHUKO DVOJNI HORIZONTALNI IP44 2x 2P+E 16A 250V~

- vijačna pritrditev vodnikov 1.5-2.5mm<sup>2</sup>
- 2x 2P+E schuko+pokrov horizontalni
- 16A 250V~, tip CF10
- ustreza EN 60884-1, CEE7

#### SOCKET SET SCHUKO DOUBLE HORIZONTAL IP44 2x 2P+E 16A 250V~

- screw contacts 1.5-2.5mm<sup>2</sup>
- 2x 2P+E schuko+cover horizontal
- 16A 250V~, type CF10
- in accordance with EN 60884-1, CEE7



- CF11PW  
 CF11GY

#### SET VTIČNICA SCHUKO DVOJNI VERTIKALNI IP44 2x 2P+E 16A 250V~

- vijačna pritrditev vodnikov 1.5-2.5mm<sup>2</sup>
- 2x 2P+E schuko+pokrov vertikalni
- 16A 250V~, tip CF11
- ustreza EN 60884-1, CEE7

#### SOCKET SET SCHUKO DOUBLE VERTICAL IP44 2x 2P+E 16A 250V~

- screw contacts 1.5-2.5mm<sup>2</sup>
- 2x 2P+E schuko+cover vertical
- 16A 250V~, type CF11
- in accordance with EN 60884-1, CEE7



- CF12PW  
 CF12GY

#### SET VTIČNICA SCH + STIKALO MEN HORIZONTALNI IP44 16A + 10AX 250V~

- vijačna (vtičnica), brezvijačna (stikalo) pritrditev vodnikov 1.5-2.5mm<sup>2</sup>
- 2P+E schuko+pokrov + stikalo menjalno horizontalni
- 16A + 10AX 250V~, tip CF12
- ustreza EN 60884-1, CEE7, EN 60669-1

#### SOCKET SCH+SWITCH SET 2WAY HORIZONTAL IP44 16A + 10AX 250V~

- screw (socket), plug-in (switch) contacts 1.5-2.5mm<sup>2</sup>
- 2P+E schuko+cover + switch 2-way horizontal
- 16A + 10AX 250V~, type CF12
- in accordance with EN 60884-1, CEE7, EN 60669-1



## SET VTIČNICA SCH + STIKALO MEN VERTIKALNI IP44 16A + 10AX 250V~



- CF13PW
- CF13GY

- vijačna (vtičnica), brezvijačna (stikalo) pritrditev vodnikov 1.5-2.5mm<sup>2</sup>
- 2P+E schuko+pokrov + stikalo menjalno vertikalni
- 16A + 10AX 250V~, tip CF13
- ustreza EN 60884-1, CEE7, EN 60669-1

## SOCKET SCH+SWITCH 2WAY SET VERTICAL IP44 16A + 10AX 250V~

- screw (socket), plug-in (switch) contacts 1.5-2.5mm<sup>2</sup>
- 2P+E schuko+cover + switch 2-way vertical
- 16A + 10AX 250V~, type CF13
- in accordance with EN 60884-1, CEE7, EN 60669-1



## SET VTIČNICA SCHUKO DVOJNI HORIZONTALNI IP44 2x 2P+E 16A 250V~BV



- CF14PW
- CF14GY

- BV brezvijačna pritrditev vodnikov 1.5-2.5mm<sup>2</sup>
- 2x 2P+E schuko+pokrov horizontalna
- 16A 250V~, tip CF14
- ustreza EN 60884-1, CEE7

## SOCKET SET SCHUKO DOUBLE HORIZONTAL IP44 2x 2P+E 16A 250V~ BV

- BV plug-in contacts 1.5-2.5mm<sup>2</sup>
- 2x 2P+E schuko+cover horizontal
- 16A 250V~, type CF14
- in accordance with EN 60884-1, CEE7



## SET VTIČNICA SCHUKO DVOJNI VERTIKALNI IP44 2x 2P+E 16A 250V~ BV



- CF15PW
- CF15GY

- BV brezvijačna pritrditev vodnikov 1.5-2.5mm<sup>2</sup>
- 2x 2P+E schuko+pokrov vertikalna
- 16A 250V~, tip CF15
- ustreza EN 60884-1, CEE7

## SOCKET SET SCHUKO DOUBLE VERTICAL IP44 2x 2P+E 16A 250V~ BV

- BV plug-in contacts 1.5-2.5mm<sup>2</sup>
- 2x 2P+E schuko+cover vertical
- 16A 250V~, type CF15
- in accordance with EN 60884-1, CEE7



## SET VTIČNICA SCH + STIKALO MEN HORIZONTALNI IP44 16A + 10AX 250V~ BV



- CF16PW
- CF16GY

- BV brezvijačna pritrditev vodnikov 1.5-2.5mm<sup>2</sup>
- 2P+E schuko+pokrov + stikalo menjalno horizontalni
- 16A + 10AX 250V~, tip CF16
- ustreza EN 60884-1, CEE7, EN 60669-1

## SOCKET+SWITCH SET SCH+2WAY HORIZONTAL IP44 16A + 10AX 250V~ BV

- BV plug-in contacts 1.5-2.5mm<sup>2</sup>
- 2P+E schuko+cover + switch 2-way horizontal
- 16A + 10AX 250V~, type CF16
- in accordance with EN 60884-1, CEE7, EN 60669-1



## SET VTIČNICA SCH+STIKALO MEN VERTIKALNI IP44 16A + 10AX 250V~ BV



- CF17PW
- CF17GY

- BV brezvijačna pritrditev vodnikov 1.5-2.5mm<sup>2</sup>
- 2P+E schuko+pokrov + stikalo menjalno vertikalni
- 16A + 10AX 250V~, tip CF17
- ustreza EN 60884-1, CEE7, EN 60669-1

## SOCKET SCH+SWITCH 2WAY SET VERTICAL IP44 16A + 10AX 250V~ BV

- BV plug-in contacts 1.5-2.5mm<sup>2</sup>
- 2P+E schuko+cover + switch 2-way vertical
- 16A + 10AX 250V~, type CF17
- in accordance with EN 60884-1, CEE7, EN 60669-1



# P R I B O R A F A C C E S S O R I E S

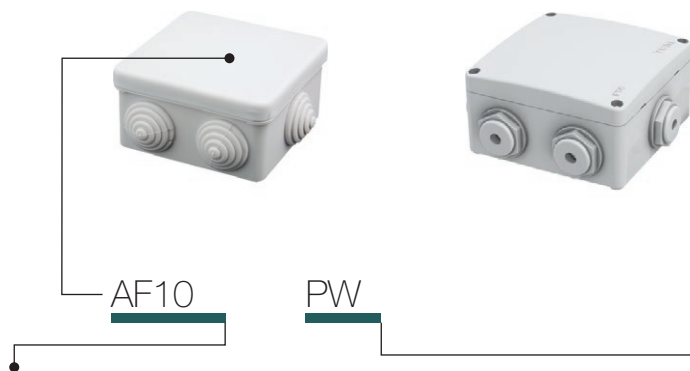

tip type	naziv description	tehnični opis technical data	barva colour
AF10	RAZVODNICA DISTRIBUTION BOX	IP44 RN01	<input type="checkbox"/> PW bela-mat white-mat
AF20	RAZVODNICA DISTRIBUTION BOX	IP55 NDO1	<input type="checkbox"/> GY siva-mat grey-mat

## RAZVODNICA IP44 RN01



- AF10PW
- AF10GY

- nadometna razvodnica IP44  
- 16A 400V~  
- ustreza IEC/EN 60670-1, IEC/EN 60670-22  
**DISTRIBUTION BOX IP44 RN01**  
- surface mounting distribution box IP44  
- 16A 400V~  
- in accordance with IEC/EN 60670-1, IEC/EN 60670-22

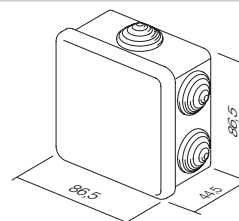

## RAZVODNICA IP55 ND01



- AF20PW
- AF20GY

- nadometna razvodnica IP55  
- uvodnice priložene  
- ustreza IEC/EN 60670-1, IEC/EN 60670-22  
**DISTRIBUTION BOX IP55 ND01**  
- surface mounting connection box IP55  
- glands included  
- in accordance with IEC/EN 60670-1, IEC/EN 60670-22

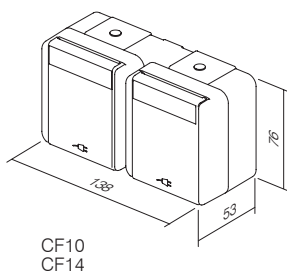
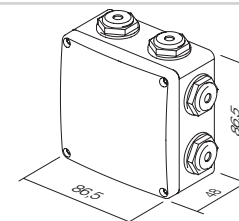

CF10  
CF14

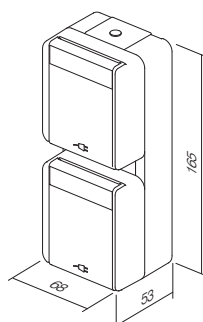

CF11  
CF15

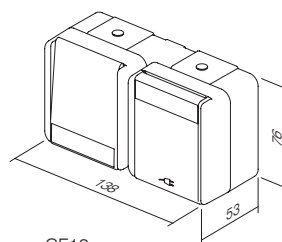

CF12  
CF16

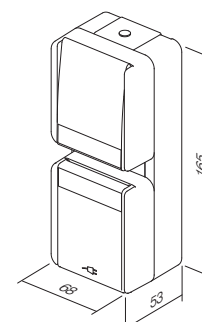

CF13  
CF17

šifra	opis izdelka	stran	šifra	opis izdelka	stran
<b>STIKALA SM</b>			<b>KOMUNIKACIJE KM</b>		
SM10	STIKALO ENOPOLNO 16AX 250V~ 1M	68	KM10--	VTIČNICA TV OSNOVNA 0dB 1M	82
SM11	TIPKALO ENOPOLNO 16A 250V~ 1M	68	KM20--	VTIČNICA TV OSNOVNA 0dB 2M	82
SM12	STIKALO ENOPOLNO 20A 250V~ 1M	68	KM11--	VTIČNICA TV KONČNA 1dB 1M	82
SM20	STIKALO DVOPOLNO 16AX 250V~ 1M	68	KM12--	VTIČNICA TV PREHODNA 10dB 1M	82
SM40	STIKALO ŽALUZIJSKO 1-0-2 16AX 250V~ 1M	69	KM15--	VTIČNICA SAT OSNOVNA 0dB 1M	83
SM41	TIPKALO ŽALUZIJSKO 1-0-2 16A 250V~ 1M	69	KM24--	VTIČNICA SAT OSNOVNA 0dB 2M	83
SM60	STIKALO MENJALNO 16AX 250V~ 1M	69	KM16--	VTIČNICA SAT KONČNA 1dB 1M	83
SM61	TIPKALO MENJALNO 16A 250V~ 1M	69	KM19--	VTIČNICA R OSNOVNA 0dB 1M	83
SM70	STIKALO KRIŽNO 16AX 250V~ 1M	69	KM29--	VTIČNICA R OSNOVNA 0dB 2M	83
SM10--	STIKALO ENOPOLNO 16AX 250V~ 1M	70	KM25--	VTIČNICA SAT-TV KONČNA 1dB 2M	83
SM10--IN	STIKALO ENOPOLNO 16AX 250V~ 1M IN	70	KM22--	VTIČNICA AVDIO 2xRCA 1M	84
SM11--	TIPKALO ENOPOLNO 16A 250V~ 1M	70	KM23--	VTIČNICA AVDIO ZVOČNIŠKA 1M	84
SM11--IN01	TIPKALO ENOPOLNO 16A 250V~ 1M IN 01	70	KM26--	VTIČNICA AVDIO ZVOČNIŠKA 2M	84
SM11--IN02	TIPKALO ENOPOLNO 16A 250V~ 1M IN 02	71	KM30--	VTIČNICA TEL LT RJ11 6/4 1M	85
SM20--NT03	STIKALO DVOPOLNO 16AX 250V~ 1M NT 03	71	KM31--	VTIČNICA TEL BT SEC 6/6 1M	85
SM20--IN	STIKALO DVOPOLNO 16AX 250V~ 1M IN	71	KM36--	VTIČNICA TEL KS RJ11 6/4 1M	85
SM40--NT10	STIKALO ŽALUZIJSKO 1-0-2 16AX 250V~ 1M NT 10	71	KM37--	VTIČNICA CAT5e KS RJ45 8/8 1M	85
SM41--NT10	TIPKALO ŽALUZIJSKO 1-0-2 16A 250V~ 1M NT 10	71	KM35--	ADAPTER KS 1M	85
SM60--	STIKALO MENJALNO 16AX 250V~ 1M	71	KM38--	ADAPTER KS S PRAŠNO ZAŠČITO 1M	85
SM61--	TIPKALO MENJALNO 16A 250V~ 1M	72	KM39--	VTIČNICA CAT6 SCH KS RJ45 8/8 1M	86
SM62--CD	TIPKALO MENJALNO Z VRVICO 16A 250V~ 1M CD	72	KM50--	ADAPTER KS UNIVERZALNI 1M	86
SM70--	STIKALO KRIŽNO 16AX 250V~ 1M	72	KM40--	ADAPTER PD 1M	86
<b>TIPKE TM</b>			KM43--	ADAPTER PD S PRAŠNO ZAŠČITO 1M	86
TM11--	TIPKA 1M	73	KM46--	ADAPTER R&M 1M	86
TM11--IN	TIPKA 1M IN	73	KM52--	ADAPTER R&M CAT6A 1M	86
TM12--	TIPKA 2M	73	KM47--	ADAPTER R&M S PRAŠNO ZAŠČITO 1M	87
TM12--IN	TIPKA 2M IN	73	KM53--	ADAPTER R&M CAT6A S PRAŠNO ZAŠČITO 1M	87
TM13--IL	TIPKA 2M Z NAPISNO PLOŠČICO	74	KM45--	ADAPTER LK 1M	88
TM15--	TIPKA 1M DVOPOLNA	74	KA26	ADAPTER NEXANS/SCRACK 2M	88
TM21--	POLNILO 1M	74	KM48--	ADAPTER AT&T SYSTIMAX S PRAŠNO ZAŠČITO 1M	88
TM22--	POLNILO 2M	74	KM51--	VTIČNICA USB TIP A 1M	88
TM31--	UVODNICA 1M	74	<b>KOMUNIKACIJSKI PRIBOR KA</b>		
<b>INDIKACIJA IA</b>			KA10	KONEKTOR KS CAT3 RJ11 6/4	89
IA100R	TLIVKA 230V~ 0,34W	76	KA11	KONEKTOR KS CAT5e RJ45 8/8	89
IA20--	SIJALKA LED 230V AC/DC 0,4W	76	KA12	KONEKTOR KS CAT5eS RJ45 8/8	89
IA21--	SIJALKA LED 24V AC/DC 0,2W	76	KA15	KONEKTOR KS CAT6 SCHRACK RJ45 8/8	89
IA22--	SIJALKA LED 12V AC/DC 0,10W	76	KA16	KONEKTOR KS CAT6S SCHRACK RJ45 8/8	89
IA50	RC VEZJE 250V	76	KA17	KONEKTOR KS CAT6a SCHRACK RJ45 8/8	89
<b>VTIČNICE VM</b>			KA18	KONEKTOR SLIM KS CAT6S SCHRACK RJ45 8/8	90
VM10--	VTIČNICA SCHUKO+KS 2P+E 16A 250V~ 2M	78	KA27	KONEKTOR KS HDMI	90
VM11--	VTIČNICA SCHUKO+KS+POKROV 2P+E 16A 250V~ 2M	78	KA28	KABEL KS HDMI	90
VM20--	VTIČNICA EURO+KS 2P 10A 250V~ 1M	79	<b>ELEKTRONIKA EM</b>		
VM40--	VTIČNICA FRANCOSKA+KS 2P+E 16A 250V~ 2M	79	EM10--	ZATEMNILNIK ROTACIJSKI R 300W 1M	91
VM41--	VTIČNICA FRANCOSKA+KS+POKROV 2P+E 16A 250V~ 2M	79	EM12--	ZATEMNILNIK ROTACIJSKI/MENJALNI RL 300W 1M	91
VM30--	VTIČNICA ITALIJANSKA P17/11+KS 2P+E 16A 250V~ 1M	79	EM13--	ZATEMNILNIK ROTACIJSKI/MENJALNI LED 60W 1M	92
VM31--	VTIČNICA SCHUKO/ITA P17/11+KS 2P+E 16A 250V~ 2M	79	EM14--	ZATEMNILNIK ROTACIJSKI/MENJALNI LED 180W 1M	92
VM32--	VTIČNICA SCHUKO/ITA P30+KS 2P+E 16A 250V~ 2M	80	EM15--	ZATEMNILNIK ROTACIJSKI R 250W 1M	92
VM33--	VTIČNICA ITALIJANSKA P11+KS 2P+E 10A 250V~ 1M	80	EM23	ZATEMNILNIK VGRADNI R (250 W), (RC,RL 200VA)	93
VM21--	VTIČNICA EURO/AMERIŠKA+KS 2P 16A 250V~ 1M	80	EM18	ZATEMNILNIK VGRADNI LED 250W	93
VM51--	VTIČNICA BRITANSKA BS546+KS 2P+E 15A 250V~ 2M	80	EM19	ZATEMNILNIK VGRADNI DC LED 96W	93
VM52--	VTIČNICA BRITANSKA BS 1363+KS 2P+E 13A 250V~ 2M	80	EM25--	STIKALO/ZATEMNILNIK UNIVERZALNI RLC 0-300W 2M	95
VM80	PRENAPETOSTNA ZAŠČITA MPE MINI 275V/50Hz	80	EM26--	TIPKALO UPRAVLJALNO 2M	97
			EM27	FILTER OMREŽNIH MOTENJ	97
			EM25PPOL20	SET STIKALO / ZATEMNILNIK UNIVERZALNI RLC 0-300W 2M PP OL20	97
			EM31--	IR STIKALO 5A 230V~ 1M	98
			EM32--	IR STIKALO 5A 230V~ 2M	98
			EM37--	TERMOSTAT OSNOVNI 6A 230V~2M	100
			NM39	NOSILEC Z VIJAKI ZA TERMOSTATE FANTINI COSMI 3M	101
			EM40--	KARTIČNO STIKALO ZA VARČEVANJE Z ENERGIJO 3A 250V~ 3M	101
			EM47	KARTICA ISO	101
			EM44--	KARTIČNO STIKALO ZA VARČEVANJE Z ENERGIJO RF HF 13,56MGz 3M	102
			EM49	RELE ENOTA ZA KARTIČNO STIKALO 2x16A 250V	102
			EM45	RAZDELILNIK SPL-1	102
			EM60--	VTIČNICA ZA BRIVNIK 230V~/120V~ 3M	103
			EM66--	POLNILNIK USB 5V 2.1A 1M	103
			EM65--	POLNILNIK USB 5V 1A 2M	103
			EM67--	POLNILNIK USB 5V 2.4A 1M	104
			EM55	LED ZASILNA SVETILKA 250V~ 0,9W, NiCd 3h 7M	104
			EM57	LED ZASILNA SVETILKA 230V~ 50 Hz 0,5W, NiMH 2h 2M	104
			EM50--	SVETILKA LED ENOBARVNA 250V~ 0,8W 2M	105
			EM51--	SVETILKA LED DVOBARVNA 250V~ 2x0,4W 2M	105
			EM52--	SVETILKA LED 3D DVOBARVNA 250V~ 2x0,4W 2M	105
			EM71--	STIKALO NA PRSTNI ODTIS BIOPASS 2M	106
			EM80--	STIKALO BREZDOTIČNO 10A 240V~	107
			EM81--	STIKALO BREZDOTIČNO UPRAVLJALNO	107
			EM90--	BRENČAČ 8VA 230V~ 1M	108
			EM91--	BRENČAČ 8VA 12V 1M	108
			EM92--	ZVONEC 8VA 230V~ 1M	108
			EM93--	ZVONEC 8VA 12V 1M	108
			EM95--	REGULATOR GLASNOSTI ZA 100V AVDIO LINIJO 35W 2M	109
			EM96--	REGULATOR GLASNOSTI NIZKOOHMSKI 4-8 Q 35W 2M	109

šifra	opis izdelka	stran	šifra	opis izdelka	stran
<b>SETI CM</b>			<b>OKROGLE DOZE</b>		
CM10--	SET VTIČNIC 2x SCHUKO 2P+E 16A 250V~ 4M	110	DE10	DOZA OKROGLA ZA ZID SM60-01	140
CM11--	SET VTIČNIC 3x SCHUKO 2P+E 16A 250V~ 7M	110	DE11	DOZA OKROGLA ZA ZID GLOBOKA SM60-06	140
CM15	SET VEZNIKOV BARVNI 3x1,5mm <sup>2</sup> 1M	111	DE30	VEZNI ČLEN DOZE ZA ZID SM60-03	140
CM16	SET VEZNIKOV BARVNI 3x2,5mm <sup>2</sup> 2M	111	DE31	VEZNI ČLEN DOZE ZA ZID SM60-04	140
CM17	SET VIJAKOV 3,5x20	111	DE12	DOZA OKROGLA ZA ZID 65-46	141
CM18	SET VIJAKOV 3,5x35	111	DE13	DOZA OKROGLA ZA ZID 65-60	141
CM19	SET VIJAKOV 3,5x50	111	DE14	PODALJŠEK DOZE ZA ZID 65-46	141
CM22--	SET ZA STIKALA IP44 2M	111	DE32	VEZNI ČLEN DOZE ZA ZID 65-71	141
CM23--	SET ZA VTIČNICE IP44 2M	111	DE33	VEZNI ČLEN DOZE ZA ZID 65-91	141
CM25--OL	KOPALNIŠKI SET 3x20A 250V~ 4M OL	111	DE20	POKROV DOZE ZAŠČITNI 60	141
CM25--OS	KOPALNIŠKI SET 3x20A 250V~ 4M OS	111	DE21	POKROV DOZE ZAŠČITNI 65	141
NM41	NOSILEC KOPALNIŠKI SET 4M	112	DE22	POKROV DOZE DEKORATIVNI SM60	141
OL41--	OKVIR LINE KOPALNIŠKI SET	112	HE10	DOZA OKROGLA ZA VOTLE STENE SM68x40	144
OS41--	OKVIR SOFT KOPALNIŠKI SET	112	HE11	DOZA OKROGLA ZA VOTLE STENE SM68x55	144
<b>ANTIBAKTERIJSKI PROGRAM AW</b>			BE10	DOZA OKROGLA ZA BETON 60-49	144
TM11AW	TIPKA 1M	115	BE11	DOZA OKROGLA ZA BETON 60-77	144
TM11AWIN	TIPKA 1M IN	115	BE20	NOSILEC DOZE ZA BETON	144
TM12AW	TIPKA 2M	115	BE21	UVODNICA DOZE ZA BETON 16	144
TM12AWIN	TIPKA 2M IN	115	<b>PRAVOKOTNE DOZE</b>		
TM21AW	POLNILO 1M	115	DM30	DOZA PRAVOKOTNA ZA ZID PM3	148
TM22AW	POLNILO 2M	115	DM31	DOZA PRAVOKOTNA ZA ZID PM3-65	148
VM10AW	VTIČNICA SCHUKO+KS 2P+E 16A 250V~ 2M	116	DM40	DOZA PRAVOKOTNA ZA ZID PM4	148
VM11AW	VTIČNICA SCHUKO+KS+POKROV 2P+E 16A 250V~ 2M	116	DM41	DOZA PRAVOKOTNA ZA ZID PM4-65	148
VM20AW	VTIČNICA EURO+KS 2P 10A 250V~ 1M	116	DM70	DOZA PRAVOKOTNA ZA ZID PM7	149
KM11AW	VTIČNICA TV KONČNA 1dB 1M	116	DM71	DOZA PRAVOKOTNA ZA ZID PM7-65	149
KM35AW	ADAPTER KS 1M	116	DM72	DOZA PRAVOKOTNA ZA ZID PM72-65	149
OS20AW	OKVIR SOFT 2M	117	DM80	VEZNI ČLEN DOZE PM	149
OS24AW	OKVIR SOFT 2x2M	117	DM33	POKROV DOZE ZAŠČITNI PM3	150
OS26AW	OKVIR SOFT 3x2M	117	DM34	POKROV DOZE DEKORATIVNI PM3	150
OS30AW	OKVIR SOFT 3M	117	DM43	POKROV DOZE ZAŠČITNI PM4	150
OS40AW	OKVIR SOFT 4M	117	DM44	POKROV DOZE DEKORATIVNI PM4	150
OS70AW	OKVIR SOFT 7M	117	DM73	POKROV DOZE ZAŠČITNI PM7	150
<b>OKVIRJI PURE OP</b>			DM74	POKROV DOZE DEKORATIVNI PM7	150
OP20--	OKVIR PURE 2M	120	DM75	POKROV DOZE DEKORATIVNI PM72	151
OP24--	OKVIR PURE 2x2M	120	HM30	DOZA PRAVOKOTNA ZA VOTLE STENE VM3	152
OP26--	OKVIR PURE 3x2M	120	HM40	DOZA PRAVOKOTNA ZA VOTLE STENE VM4	152
OP28--	OKVIR PURE 4x2M	120	HM70	DOZA PRAVOKOTNA ZA VOTLE STENE VM7	152
OP30--	OKVIR PURE 3M	121	HM72	DOZA PRAVOKOTNA ZA VOTLE STENE VM72	152
OP40--	OKVIR PURE 4M	121	BM30	DOZA PRAVOKOTNA ZA BETON BM3	153
OP70--	OKVIR PURE 7M	121	BM40	DOZA PRAVOKOTNA ZA BETON BM4	153
OP13--	OKVIR PURE 1/3M	121	BM70	DOZA PRAVOKOTNA ZA BETON BM7	153
OP23--	OKVIR PURE 2/3M	121	BM80	PRITRDLJNI ČLEN DOZ BM	153
<b>OKVIRJI LINE OL</b>			BM82	DISTANČNI PROFIL ZA DOZE	153
OL20--	OKVIR LINE 2M	124	<b>RAZVODNE DOZE</b>		
OL24--	OKVIR LINE 2x2M	124	DW10	RAZVODNA DOZA OKROGLA ZA ZID DSM78	156
OL26--	OKVIR LINE 3x2M	124	HW10	RAZVODNA DOZA OKROGLA ZA VOTLE STENE SM78x45	156
OL28--	OKVIR LINE 4x2M	124	DE23	POKROV DOZE DEKORATIVNI SM78	156
OL29--	OKVIR LINE 5x2M	124	DE24	POKROV DOZE ZAŠČITNI 78	156
OL30--	OKVIR LINE 3M	125	HW20	RAZVODNA DOZA KVADRATNA ZA ZID SM105x105	156
OL40--	OKVIR LINE 4M	125	<b>PRIBOR ZA OŽIČENJE</b>		
OL70--	OKVIR LINE 7M	125	UW10--	ENOREDNE SPONKE ZAPRTE PC 2x2,5mm <sup>2</sup> 10P	158
OL10--	OKVIR LINE 1/2M	125	UW11--	ENOREDNE SPONKE ZAPRTE PC 2x4mm <sup>2</sup> 10P	158
OL13--	OKVIR LINE 1/3M	125	UW12--	ENOREDNE SPONKE ZAPRTE PC 2x6mm <sup>2</sup> 10P	158
OL23--	OKVIR LINE 2/3M	125	UW15--	ENOREDNE SPONKE PA 2x2,5mm <sup>2</sup> 12P	158
<b>OKVIRJI SOFT OS</b>			UW16--	ENOREDNE SPONKE PA 2x4mm <sup>2</sup> 12P	158
OS20--	OKVIR SOFT 2M	128	UW17--	ENOREDNE SPONKE PA 2x6mm <sup>2</sup> 12P	158
OS24--	OKVIR SOFT 2x2M	128	UW29--	DVOREDNE SPONKE PP 1.0-4.0mm <sup>2</sup> 12P	158
OS26--	OKVIR SOFT 3x2M	128	UW30--	DVOREDNE SPONKE PP 1.5-6.0mm <sup>2</sup> 12P	158
OS28--	OKVIR SOFT 4x2M	128	UW31--	DVOREDNE SPONKE PP 2.5-10mm <sup>2</sup> 12P	158
OS30--	OKVIR SOFT 3M	129	UW32--	DVOREDNE SPONKE PP 4.0-16mm <sup>2</sup> 12P	158
OS40--	OKVIR SOFT 4M	129	UW25--	DVOREDNE SPONKE PA 1.0-4.0mm <sup>2</sup> 12P	159
OS70--	OKVIR SOFT 7M	129	UW26--	DVOREDNE SPONKE PA 1.5-6.0mm <sup>2</sup> 12P	159
OS72--	OKVIR SOFT 2x7M	129	UW27--	DVOREDNE SPONKE PA 2.5-10mm <sup>2</sup> 12P	159
OS10--	OKVIR SOFT 1/2M	129	UW28--	DVOREDNE SPONKE PA 4.0-16mm <sup>2</sup> 12P	159
OS13--	OKVIR SOFT 1/3M	129	UW40--	BREZVIJAČNE SPONKE PA 1.5mm <sup>2</sup> 3P	159
OS23--	OKVIR SOFT 2/3M	129	UW41--	BREZVIJAČNE SPONKE PA 1.5mm <sup>2</sup> 5P	159
<b>NOSILCI NM</b>			UW42--	BREZVIJAČNE SPONKE PA 1.5mm <sup>2</sup> 8P	159
NM20	NOSILEC S KREMPELJCI 2M	134	UW45--	BREZVIJAČNE SPONKE PA 2.5mm <sup>2</sup> 3P	159
NM21	NOSILEC BREZ VIJAKOV 2M	134	UW46--	BREZVIJAČNE SPONKE PA 2.5mm <sup>2</sup> 4P	159
NM24	NOSILEC KOVINSKI S KREMPELJCI 2M	134	UW47--	BREZVIJAČNE SPONKE PA 2.5mm <sup>2</sup> 5P	159
NM25	NOSILEC KOVINSKI BREZ VIJAKOV 2M	134	UW50--	BREZVIJAČNE SPONKE PA 2.5mm <sup>2</sup> 2/1P	159
NM30	NOSILEC Z VIJAKI 3M	135			
NM40	NOSILEC Z VIJAKI 4M	135			
NM70	NOSILEC Z VIJAKI 7M	135			
NM72	NOSILEC Z VIJAKI 2x7M	135			
NM10	NOSILEC S KREMPELJCI 1/2M	136			
NM11	NOSILEC BREZ VIJAKOV 1/2M	136			
NM23	NOSILEC S KREMPELJCI 2/3M	136			
NM32	NOSILEC Z VIJAKI 2/3M	136			



## distribucija —

šifra	opis izdelka	stran
<b>OHIŠJA CUBO IP20 AC</b>		
AC11--	OHIŠJE NO CUBO Z DNOM IP20 1M	162
AC21--	OHIŠJE NO CUBO Z DNOM IP20 2M	162
AC41--	OHIŠJE NO CUBO Z DNOM IP20 4M	162
AC61--	OHIŠJE NO CUBO Z DNOM IP20 6M	162
<b>OHIŠJA CUBO IP55 AQ</b>		
AQ20--	OHIŠJE NO CUBO IP55 2M	163
AQ22--	OHIŠJE NO CUBO IP55 2x2M	163
AQ30--	OHIŠJE NO CUBO IP55 3M	163
AQ31--	OHIŠJE PO CUBO IP55 3M	163
AQ21--	OHIŠJE PO CUBO IP55 2M	164
<b>PARAPETNI KANALI ALUMINIJSKI MA</b>		
RT10	ADAPTER MA 92	165
RT12--	OKVIR MA 92 2/3M	165
RT14--	OKVIR MA 92 4M	165
RT17--	OKVIR MA 92 7M	165
RT20--	OSNOVA KANALA MA 130x65	166
RT21--	OSNOVA KANALA MA 165x65	166
RT25--	POKROV KANALA MA 92	166
RT30	PREGRAĐA MA 43	166
RT31	PREGRAĐA MA 43 AL	166
RT32	PREGRAĐA MA 43 AL DVOJNA	166
RT35--	KONČNI ELEMENT MA 130x65	167
RT36--	KONČNI ELEMENT MA 165x65	167
RT38	SET RAVNI VEZNI ELEMENT MA 65	167
RT40--	UNIVERZALNI KOT MA 130x65	167
RT41--	UNIVERZALNI KOT MA 165x65	167
RT42	OZEMLJITVENA SPONKA MA 2x A6.3	167
RT43--	L KOTNI ELEMENT MA 130x65	168
RT44--	L KOTNI ELEMENT MA 165x65	168
RT45--	T ELEMENT MA 130x65	168
RT46--	T ELEMENT MA 165x65	168
RT50--	NOSILEC STEBRIČKA MA ENOJNI 130x65	169
RT51--	NOSILEC STEBRIČKA MA DVOJNI 130x65	169
RT52--	STEBRIČEK MA 130x65x500	169
RT53--	STEBRIČEK MA DVOJNI 130x65x500	169
<b>TALNE DOZE MT</b>		
RB30	TALNA DOZA MT 7 H=53mm	171
RB40	TALNA DOZA MT 7 H=88mm	171
RB31	PODSTAVEK TALNE DOZE MT 7 H=53mm	171
RB41	PODSTAVEK TALNE DOZE MT 7 H=88mm	171
RB33	TALNA DOZA MT 14 H=53mm	171
RB43	TALNA DOZA MT 14 H=88mm	171
RB34	PODSTAVEK TALNE DOZE MT 14 H=53mm	172
RB44	PODSTAVEK TALNE DOZE MT 14 H=88mm	172
RB36	TALNA DOZA MT 21 H=53mm	172
RB46	TALNA DOZA MT 21 H=88mm	172
RB37	PODSTAVEK TALNE DOZE MT 21 H=53mm	172
RB47	PODSTAVEK TALNE DOZE MT 21 H=88mm	172
<b>RAZVODNE OMARICE MO</b>		
RB10	ADAPTER ZA DIN LETEV 35mm 1M	173
RB11	ADAPTER ZA DIN LETEV 35mm 2M	173
RB20	RAZVODNA OMARICA MO 12+2	174
RB21	RAZVODNA OMARICA MO 24+4	174
RB22	RAZVODNA OMARICA MO 36+6	174
RB23	RAZVODNA OMARICA MO 48+8	174

## ekonomik —

šifra	opis izdelka	stran
<b>STIKALA SE</b>		
SE10	STIKALO ENOPOLNO 10AX 250V~	188
SE11	TIPKALO ENOPOLNO 10A 250V~	188
SE22	STIKALO DVOPOLNO 16AX 250V~	188
SE50	STIKALO SERIJSKO 10AX 250V~	188
SE51	TIPKALO SERIJSKO 10A 250V~	189
SE52	STIKALO ŽALUZIJSKO 10AX 250V~	189
SE53	TIPKALO ŽALUZIJSKO 10A 250V~	189
SE60	STIKALO MENJALNO 10AX 250V~	189
SE63	STIKALO DVOJNO MENJALNO 10AX 250V~	189
SE70	STIKALO KRIŽNO 10AX 250V~	189
SE10--	STIKALO ENOPOLNO 10AX 250V~	190
SE10--IN	STIKALO ENOPOLNO 10AX 250V~ IN	190
SE11--	TIPKALO ENOPOLNO 10A 250V~	190
SE11--TI50	TIPKALO ENOPOLNO 10A 250V~ TI 50	190
SE11--TI51	TIPKALO ENOPOLNO 10A 250V~ TI 51	190
SE11--IL	TIPKALO ENOPOLNO 10A 250V~ IL	190
SE22--IN03	STIKALO DVOPOLNO 16AX 250V~ IN 03	190
SE50--	STIKALO SERIJSKO 10AX 250V~	191
SE51--	TIPKALO SERIJSKO 10A 250V~	191
SE52--NT09	STIKALO ŽALUZIJSKO 10AX 250V~ NT 09	191
SE53--NT09	TIPKALO ŽALUZIJSKO 10A 250V~ NT 09	191
SE60--	STIKALO MENJALNO 10AX 250V~	191
SE63--	STIKALO DVOJNO MENJALNO 10AX 250V~	191
SE70--	STIKALO KRIŽNO 10AX 250V~	191
<b>TIPKE TE</b>		
TE10--	TIPKA NAVADNA	192
TE10--IN	TIPKA INDIKATOR	192
TE13--IL	TIPKA Z NAPISNO PLOŠČICO IL	192
TE11--	TIPKA SERIJSKA	192
<b>INDIKACIJA IA</b>		
IA10--	TLIVKA 230V~ 0,34W	193
IA20--	SIJALKA LED 230V~ AC/DC 0,4W	193
IA21--	SIJALKA LED 24V AC/DC 0,2W	193
IA22--	SIJALKA LED 12V AC/DC 0,1W	193
<b>VTIČNICE VE</b>		
VE10--XO	VTIČNICA SCHUKO 2P+E 16A 250V~ XO	196
VE11--XO	VTIČNICA SCHUKO+POKROV 2P+E 16A 250V~ XO	196
VE12--XO	VTIČNICA SCHUKO 2P+E 16A 250V~ BV XO	196
VE13--XO	VTIČNICA SCHUKO+POKROV 2P+E 16A 250V~ BV XO	196
VE10--	VTIČNICA SCHUKO 2P+E 16A 250V~	196
VE11--	VTIČNICA SCHUKO+POKROV 2P+E 16A 250V~	196
VE12--	VTIČNICA SCHUKO 2P+E 16A 250V~ BV	196
VE13--	VTIČNICA SCHUKO+POKROV 2P+E 16A 250V~ BV	196
VE40--XO	VTIČNICA FRANCOSKA 2P+E 16A 250V~ XO	197
VE41--XO	VTIČNICA FRANCOSKA+POKROV 2P+E 16A 250V~ XO	197
VE42--XO	VTIČNICA FRANCOSKA 2P+E 16A 250V~ BV XO	197
VE43--XO	VTIČNICA FRANCOSKA+POKROV 2P+E 16A 250V~ BV XO	197
VE40--	VTIČNICA FRANCOSKA 2P+E 16A 250V~	197
VE41--	VTIČNICA FRANCOSKA+POKROV 2P+E 16A 250V~	197
VE42--	VTIČNICA FRANCOSKA 2P+E 16A 250V~ BV	197
VE43--	VTIČNICA FRANCOSKA+KS+POKROV 2P+E 16A 250V~ BV	197
VE16--	VTIČNICA SCHUKO DVOJNA 2P+E 16A 250V~	198
VE46--	VTIČNICA FRANCOSKA DVOJNA 2P+E 16A 250V~	198
VE30--	VTIČNICA 2P 16A 250V~	198
<b>KOMUNIKACIJE KE</b>		
KE11	VTIČNICA TV-R KONČNA 1dB	199
KE12	VTIČNICA TV-R PREHODNA 10dB	199
KE16	VTIČNICA SAT-TV-R KONČNA 3dB	199
KE36	VTIČNICA TEL KS RJ11 6/4	199
KE37	VTIČNICA CAT5e KS RJ45 8/8	200
KE40	VTIČNICA CAT6s KS RJ45 8/8 SLIM	200
KE38	VTIČNICA TEL KS DVOJNA 2x RJ11 6/4	200
KE39	VTIČNICA CAT5e KS DVOJNA 2x RJ45 8/8	200
KE41	VTIČNICA CAT6s KS DVOJNA 2x RJ45 8/8 SLIM	200
KE45	ADAPTER KS ENOJNI	200
KE46	ADAPTER KS DVOJNI	201
KE47	ADAPTER PD DVOJNI	201
KE10--	VTIČNICA TV OSNOVNA 0dB	202
KE11--	VTIČNICA TV-R KONČNA 1dB	202
KE12--	VTIČNICA TV-R PREHODNA 10dB	202
KE16--	VTIČNICA SAT-TV-R KONČNA 3dB	202
KE22--	VTIČNICA AVDIO 2xRCA	202
KE23--	VTIČNICA AVDIO ZVOČNIŠKA	202
KE36--	VTIČNICA TEL KS RJ11 6/4	202
KE37--	VTIČNICA CAT5e KS RJ45 8/8	203
KE40--	VTIČNICA CAT6s KS RJ45 8/8 SLIM	203
KE38--	VTIČNICA TEL KS DVOJNA 2x RJ11 6/4	203
KE39--	VTIČNICA CAT5e KS DVOJNA 2x RJ45 8/8	203
KE41--	VTIČNICA CAT6s KS DVOJNA 2x RJ45 8/8 SLIM	203
KE35--	VTIČNICA TEL LT RJ11 6/4	203

šifra	opis izdelka	stran
<b>POKROVI PA</b>		
PE10--	POKROV TV-R 2P/3P	204
PE20--	POKROV KS ENOJNI	204
PE21--	POKROV KS DVOJNI	204
PE30--	POKROV TAE/TDO	204
PE32--	POKROV IR STIKALO	204
<b>ELEKTRONIKA EE</b>		
EE15	ZATEMNILNIK ROTACIJSKI MEN RL 400W	205
EE16	ZATEMNILNIK ROTACIJSKI MEN RLC 400W	205
EE19	ZATEMNILNIK ROTACIJSKI MEN LED 100W	206
EE15--	ZATEMNILNIK ROTACIJSKI MEN RL 400W	206
EE16--	ZATEMNILNIK ROTACIJSKI MEN RLC 400W	207
EE19--	ZATEMNILNIK ROTACIJSKI MEN LED 100W	207
EE32--	IR STIKALO 5A 230V~	207
<b>POKROVI ELEKTRONIKE PE</b>		
PE41--	POKROV ZATEMNILNO STIKALO Ø6	209
<b>PRIBOR AE</b>		
AE10--	POLNILO	210
AE20--	PRIKLJUČEK PETPOLNI STALNI 3P+N+E 5x4mm <sup>2</sup>	210
AE30--	OHIŠJE NADOMETNO 1	210
AE31--	OHIŠJE NADOMETNO ZA DVOJNO VTIČNICO EKONOMIK	210
AE50--	STENSKI ŠČITNIK	211
AE51--	OTROŠKA ZAŠČITA KS	211
<b>OKVIRJI OE</b>		
OE10--	OKVIR EKONOMIK 1	212
OE20--	OKVIR EKONOMIK 2 HORIZONTALNI	212
OE21--	OKVIR EKONOMIK 2 VERTIKALNI	212
OE30--	OKVIR EKONOMIK 3 HORIZONTALNI	212
OE31--	OKVIR EKONOMIK 3 VERTIKALNI	213
OE40--	OKVIR EKONOMIK 4 HORIZONTALNI	213
OE41--	OKVIR EKONOMIK 4 VERTIKALNI	213
OE50--	OKVIR EKONOMIK 5 HORIZONTALNI	213
OE90--	DEKORATIVNI OKVIRČKI COLOR	214
<b>fontana</b>		
šifra	opis izdelka	stran
<b>STIKALA SF</b>		
SF10--	STIKALO ENOPOLNO IP44 10AX 250V~	218
SF10--TI	STIKALO ENOPOLNO IP44 10AX 250V~ TI	218
SF11--TI	TIPKALO ENOPOLNO IP44 10A 250V~ TI	218
SF20--	STIKALO DVOPOLNO IP44 10AX 250V~	218
SF50--	STIKALO SERIJSKO IP44 10AX 250V~	219
SF51--	TIPKALO SERIJSKO IP44 10A 250V~	219
SF60--	STIKALO MENJALNO IP44 10AX 250V~	219
SF60--TI	STIKALO MENJALNO IP44 10AX 250V~ TI	219
SF63--	STIKALO DVOJNO MENJALNO 10AX 250V~	219
SF70--	STIKALO KRIŽNO IP44 10AX 250V~	219
<b>VTIČNICE VF</b>		
VF10--	VTIČNICA SCHUKO+POKROV IP44 2P+E 16A 250V~	220
VF12--	VTIČNICA SCHUKO+POKROV IP44 2P+E 16A 250V~ BV	220
<b>SETI CF</b>		
CF10--	SET VTIČNICA SCHUKO DVOJNI HORIZONTALNI IP44 2x2P+E 16A 250V~	221
CF11--	SET VTIČNICA SCHUKO DVOJNI VERTIKALNI IP44 2x2P+E 16A 250V~	221
CF12--	SET VTIČNICA SCH + STIKALO MEN HORIZONTALNI IP44 16A + 10AX 250V~	221
CF13--	SET VTIČNICA SCH + STIKALO MEN VERTIKALNI IP44 16A + 10AX 250V~	222
CF14--	SET VTIČNICA SCHUKO DVOJNI HORIZONTALNI IP44 2x 2P+E 16A 250V~ BV	222
CF15--	SET VTIČNICA SCHUKO DVOJNI VERTIKALNI IP44 2x 2P+E 16A 250V~ BV	222
CF16--	SET VTIČNICA SCH + STIKALO MEN HORIZONTALNI IP44 16A + 10AX 250V~ BV	222
CF17--	SET VTIČNICA SCH+STIKALO MEN VERTIKALNI IP44 16A + 10AX 250V~ BV	222
<b>PRIBOR AF</b>		
AF10--	RAZVODNICA IP44 RN01	223
AF20--	RAZVODNICA IP55 ND01	223





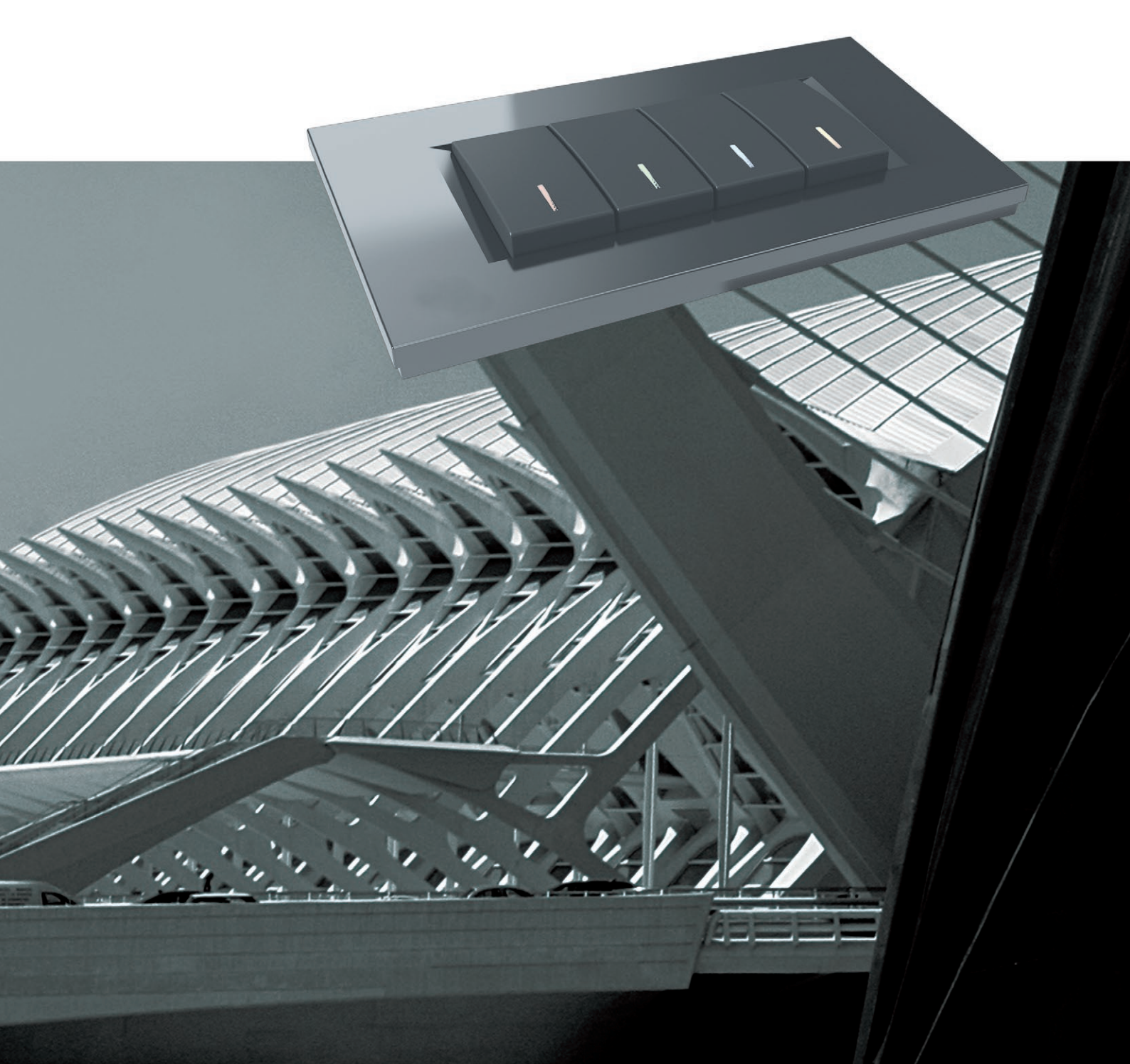

**TEM**

TEM ČATEŽ d.o.o.  
Čatež 13, 8212 VELIKA LOKA  
SLOVENIJA  
tem@tem.si  
www.tem.si  
T +386(0)7 348 99 00



SLO