

TEM 2020

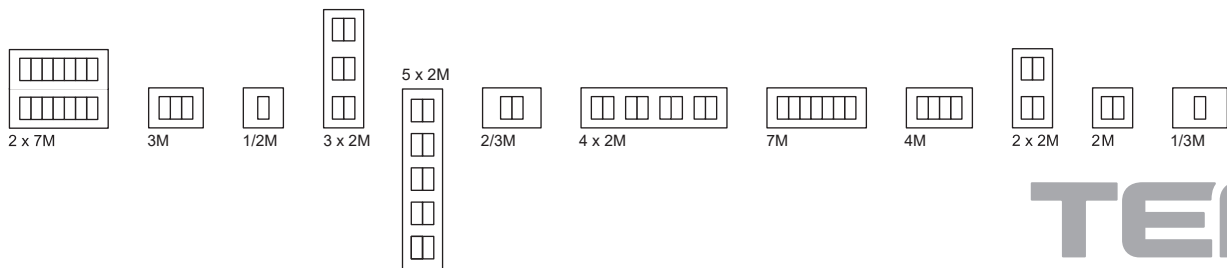

On | Off and everything in between





TEM

Vitajte v rodine Π O D U L

Welcome to the Π O D U L family

Rozširujeme a zdokonaľujeme modernú rodinu modulových spínačov pre všetky druhy Vašich miestností.

We are expanding and perfecting the modern Modul switch family for all types of rooms.



discovering new insights

objavovanie nových možností

MODUL

Dizajnové línie Pure, Line a Soft sú odrazom moderného, sofistikovaného a nezávislého životného štýlu. Môžete si vybrať zo širokej a bohatej škály farieb, vzorov a tvarov. Môžete zmeniť vzhľad svojich spínačov a zásuviek a prispôbovať ich požadovanej atmosfére a nálade.

The Pure, Line and Soft design lines reflect a modern, sophisticated and independent lifestyle. You can choose from a wide and rich selection of colours, patterns and shapes to alter the appearance of your switches and sockets so that they fit the desired atmosphere and mood.

PURE

prírodné materiály
natural materials

drevo
kov
sklo

wood
metal
glass

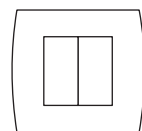

—line—



priame línie
straight lines

—soft—



jemné línie
soft lines

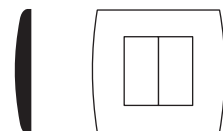
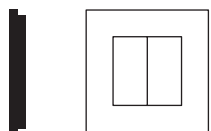

PURE



nádherné bývanie wonderful living

Z čistoty a nepoškrvnenosti novorodiaceho sa sveta, sa zrodil príbeh radu Pure. Dotyk prírodných motívov sa prelína so sofistikovaným vkusom pre línie a tvar. Je pretkaný niťou najmodernejšej technológie hraničiacej s umením.

From the cleanliness and purity of a new-born world stems the story of the Pure line. The touch of natural motifs is intertwined with a sophisticated taste for lines and form and interwoven with threads of state-of-the-art technology.



PURE

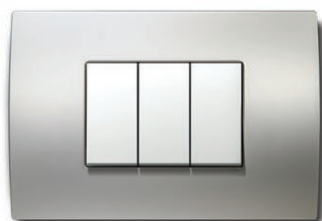



pocit prírody feeling of nature

Rad spínačov Pure sa vyznačuje prírodnými materiálmi, ako je kov, drevo a sklo. Unikátny dizajn mu dáva punc výnimočnosti. Je neobyčajný, napriek tomu však nevťieravý. Vyžaruje zmyselnosť, sofistikovanosť, vysoké štandardy a samozrejme čistotu.

The Pure switch line is distinguished by its natural materials: metal, wood and glass. Its unique design gives it a special touch. It is striking yet unobtrusive. It radiates sensuality, sophistication, high standards and, of course, cleanliness.

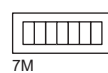
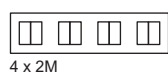

line



harmónia priamych línií harmony of straight lines

Pripravte sa na elegantnú dokonalosť rovných tvarov. Vyskúšajte lesklosť povrchov, ktoré sa jemne pohrávajú s modernými prvkami vašich priestorov. Osobitne pre vás sme do nich vniesli technológiu jemného dotyku „Soft Touch“, ktorá každý váš dotyk zmení na jedinečný zážitok.

Prepare for the elegant perfection of straight shapes. Try brilliant surfaces that gently play with modern elements of your room. We have incorporated “Soft Touch” technology especially for you, turning every touch into a unique experience.



line

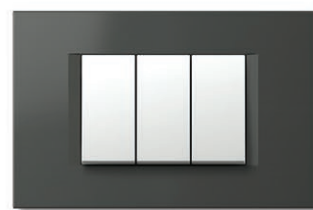
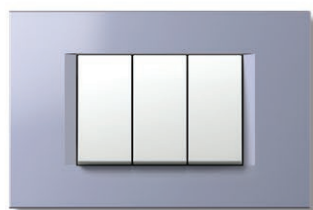
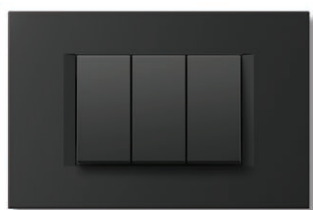
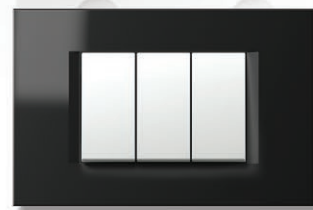
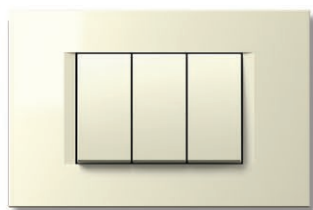
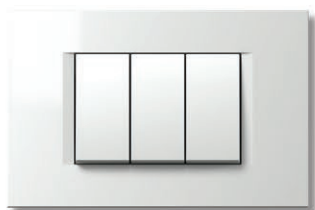
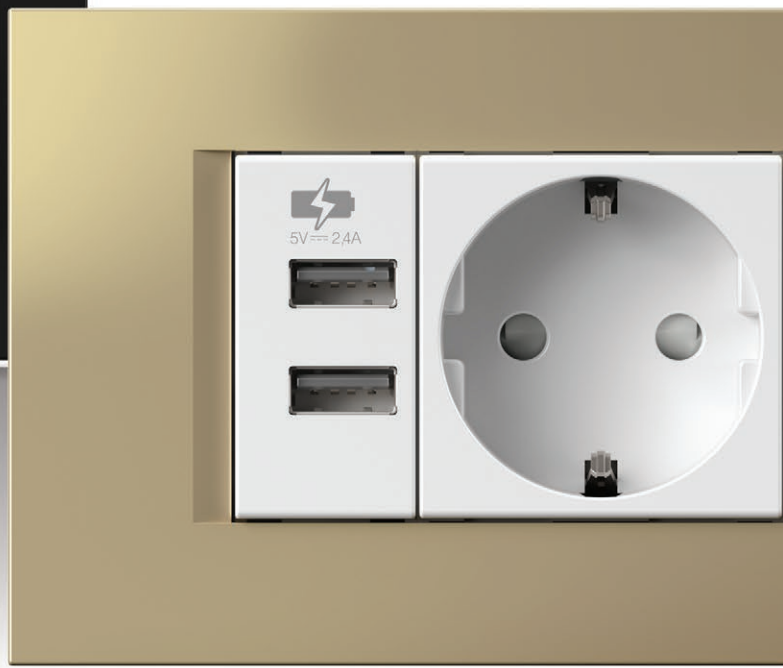

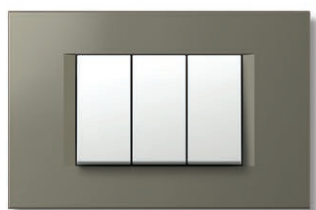

moderný dizajn modern design

Rovné, hladké línie prispievajú k nadčasovému dizajnu. Dokonale rovný, tenký profil a ergonómia mäkkého dotyku prinášajú úžasne elegantný vzhľad zo všetkých strán.

Its straight, smooth lines make for a timeless design. Its perfectly straight, sleek profile and soft-touch ergonomics give it an amazingly elegant appearance from all angles.

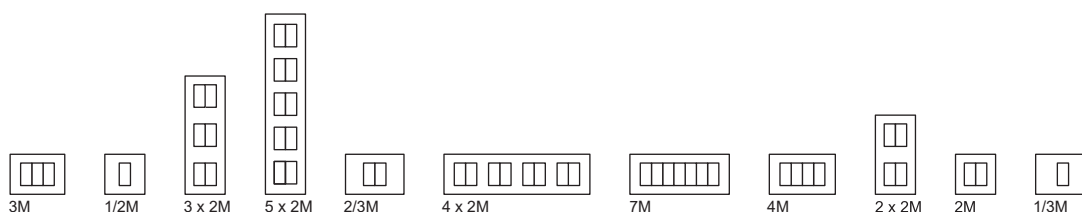

soft



jemnosť vášho domova

softness in your home

Nechajte vstúpiť jemnosť do svojho domova prostredníctvom
oblých tvarov a mäkkých prechodov.

Let the rounded shapes and soft transitions
bring softness into your home.



soft

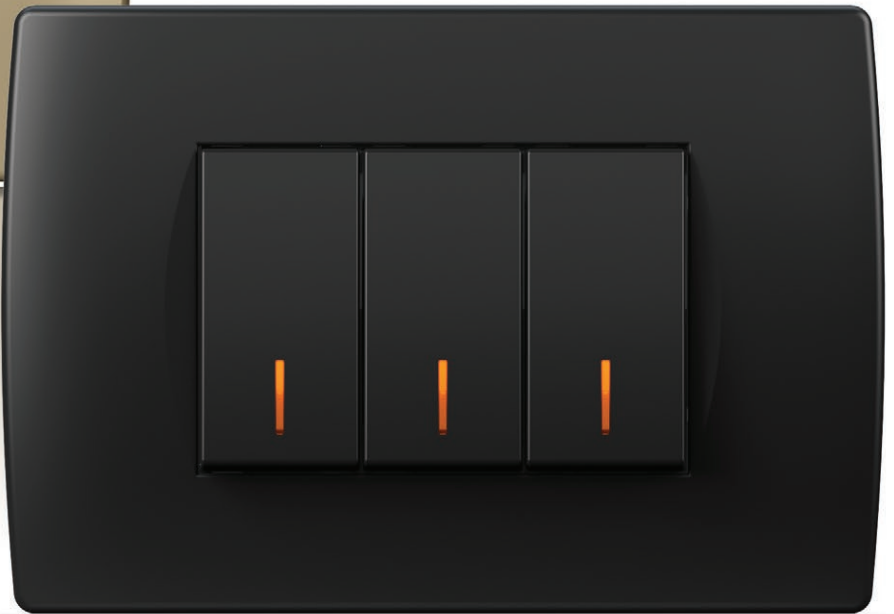



teplo domova a warm home

Dokonale mäkké tvary zakončené jemným výberom farieb a špeciálnymi povrchmi, ktoré dotykom precítite.

Perfectly soft shapes rounded off by a subtle selection of colours and special coatings for a special touch.

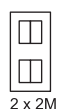
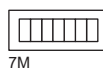
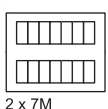



antracit

anthracite

Do našej farebnej ponuky pridávame dve celkom nové farby – ANTRACIT a TITÁN. Obe farby lahodia sofistikovanému zmyslu pre štýl našich zákazníkov a dopĺňajú detaily priestoru presne podľa ich želania. Svoj moderný byt si teraz môžete vylepšovať s harmóniou.

We are adding two colour experiences to our range – ANTHRACITE and TITANIUM. They both satisfy our customer's sophisticated sense of style and complement the details of spaces according to their wishes. Now you can upgrade your modern apartment in harmony.

módne farby

trendy colours



titán
titanium

všestranné použitie

multifunctionality



estetika

aesthetics

Vytvorili sme pre vás väčšie dekoratívne rámčeky, aby ste mohli spravovať viacero funkcií z jedného miesta. K dispozícii sú v dizajnových radoch LINE, SOFT a PURE. Dekoratívne rámčeky vyrobené z prírodných materiálov využívajú opakovanie dizajnových prvkov, ktoré ich pozdvihujú na vyššiu estetickú úroveň.

We have created larger cover plates for you that allow you to manage multiple functions from one spot. They are available in the LINE, SOFT and PURE design ranges. The cover plates, which are made from natural materials, utilise the repetition of design elements to elevate them to a high aesthetic level.



univerzálny stmievač

universal dimmer

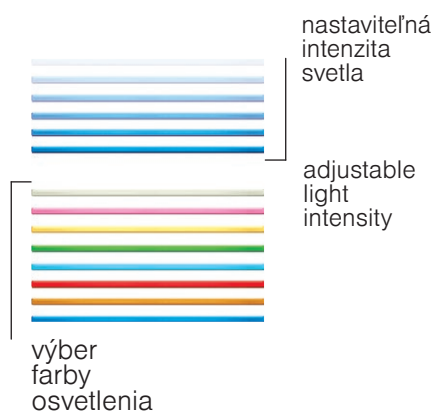

V tme sa Touch zmení na jemné, ambientné svetlo. Označuje spínač a jemne osvetľuje dané miesto. Môžete si vybrať spomedzi ôsmich rôznych farieb mäkkého svetla a upraviť jeho jas v závislosti od svojej nálady.

choosing
illumination
colour

In the dark Touch becomes a tender soft ambient light. It marks the spot of a switch and gently illuminates a place. You can choose among eight different colours of tender light and adapt its brightness according to your mood.



svetlo, aké ste ešte nikdy predtým nevideli light as never seen before

Timené svetlo vytvára pokojnú atmosféru, plnú zmyselnosti a romantiky. Je ochrannou známkou romantických miest a tichých, pokojných večerných chvíľ strávených doma alebo v práci. Mäkké a postupné zapínanie nielen predlžuje životnosť žiarovky, ale aj pomalším a príjemnejším spôsobom nahradí tmu svetlom. Touch umožňuje stlmiť svetlo bez ohľadu na typ žiarovky alebo žiarivky.

A dimmed light makes peaceful, sensual and romantic atmosphere. It is a trade mark of romantic places and quiet late evening hours spent at home or at work. Switching is soft and extended. It does not only prolong the lamp life expectancy, but also changes darkness into light in a slower and much more pleasant way. Touch enables you to dim the light anywhere, regardless of the type of lamps.





všetko na jednom mieste

everything in one place

Váš dom je centrom vášho života. Veľké množstvo zariadení, ktoré používate, vyžaduje celú škálu konektorov a zásuviek. Vytvorte si vlastné multimediálne centrum, ktoré vám umožní pripojiť a používať väčší počet rôznych komponentov na jednom mieste.

Your house is the centre of your life. The multitude of devices you use requires a number of connectors and sockets. Create your own multimedia centre, one that will allow you to connect and use a multiple number of different components in one place.



inovačný regulátor teploty

innovative temperature controller

Urobte si pohodlie nastavením teploty vašich obytných a pracovných priestorov počas všetkých ročných období. Termostat vám umožňuje ovládať vykurovacie a chladiace zariadenia s možnosťou ekonomického režimu.

Make yourself comfortable by controlling the temperature in your living and working rooms during all seasons with a smart thermostat. It allows you to control heating and cooling devices and features an eco-function.

komfort vo vašej izbe

comfort in your room

27



praktické použitie

convenience of use



TOUCHLESS - bez dotyku

S bezdotykovým spínačom si môžete užívať moderný životný štýl, ktorý umožňuje zapnutie a vypnutie svetiel bez nutnosti fyzického dotyku. Túto voľbu oceníte, keď budete mať plné alebo špinavé ruky a budete môcť dosiahnuť požadované osvetlenie bez zbytočnej námahy.

The touchless switch allows you to enjoy a modern lifestyle, enabling the turning on and off of your lights, without the need for physical interaction. This option is very useful when you find yourself with your hands full, or dirty, as you can achieve the desired lighting without undue fuss.



moderné osvetlenie

modern illumination





3D svetlo

3D lamp

Rýchle životné tempo znamená, že ste neustále vystavovaný veľkému množstvu informácií. Farebné 3D svetlo predstavuje elegantné riešenie pre informačné a smerové označenia. Grafiku vám pripravíme podľa vašich želaní.

The rapid pace of life means you are constantly being bombarded with a plenty of information. 3D colour lamp provide an elegant solution for information and direction signs. We can make graphics according to your wishes.



BIOPASS - odomykanie bez klúčov

BIOPASS – keyless unlocking

BIOPASS je novou generáciou spínača na odomykanie bez klúčov. Spája pokrokovú technológiu rozpoznávania odtlačkov prstov a rýchleho otvárania vchodových dverí.

Stačí len položiť prst na spínač Biopass a dvere do vášho domu alebo kancelárie sa otvoria. Tak jednoduché a tak bezpečné. Riadite ho prostredníctvom mobilnej aplikácie.

BIOPASS is the new generation of switches for keyless unlocking. It combines advanced fingerprint recognition technology with quick front door opening.

Simply put your finger on the Biopass switch and the doors to your home or office will open. It is so easy to use and incredibly secure. You can manage it effortlessly via the mobile app.

zvýšenie bezpečnosti improved security

33



osobitosť

individuality



vytvorte si vlastný dizajn

make it your own

Buďte iný a odlište sa. Vytvorte si spínač podľa Vašich predstáv. Vybrať si môžete spomedzi rôznych farieb rámkov a my Vám ho ozdobíme vlastnou grafikou alebo značkami. Vyberte si farbu osvetlenia, ktorá vyhovuje atmosfére vašej izby.

Be different. Make a switch according to your taste. You can choose between different frame colours and we can decorate them for you with custom graphics or signs. Choose a illumination colour that suits the ambience of your room.



vhodné pre použitie na verejnosti
suitable for public use



kvalita a trvanlivosť quality and durability

Kvalitné a odolné materiály zaručujú dlhú životnosť modulárnych spínačov a zásuviek MODUL. Systém je preto vhodný na inštaláciu a bezstarostné používanie vo verejných inštitúciách, obchodných budovách, turistických ubytovacích zariadeniach, obchodných centrách, školách a športových objektoch. Prispôsobí sa modernej architektúre a aj klasickým interiérom.

Quality and durable materials ensure the long lifetime of the MODUL modular switches and sockets. The system is suitable for mounting and carefree use in public facilities, business premises, tourist accommodation, shopping centres, schools and sports facilities. It fits perfectly in both modern architecture and classical interiors.





výkonné USB nabíjačky powerful USB chargers

S výkonnými USB nabíjačkami Modul rýchlo a jednoducho nabijete inteligentné telefóny, tablety a ostatné elektronické zariadenia prostredníctvom štandardného USB konektoru. K dispozícii sú vo veľkostiach 1M a 2M. Sú ideálne na súkromné a aj verejné použitie.

The powerful Modul USB chargers enable the fast and simple charging of your smartphones, tablets and other electronic devices via a standard USB connection. They are available in 1M and 2M sizes and are perfect for use in private and public rooms.

rýchle nabíjanie

fast charging



moderné pracovné prostredie a modern working environment





estetické hliníkové kanály aesthetic aluminium trunkings

Postarajte sa o estetickosť kancelárskych, školských a pracovných priestorov. Zbavte sa viditeľných káblov a nepraktických predlžovacích káblov. Elegantné hliníkové kanály moderného vzhľadu ponúkajú dostatok priestoru pre elektrické inštalácie. Spínače, zásuvky a komunikačné prípojky sú rýchlo dostupné a k dispozícii tam, kde ich potrebujete. Môžete ich jednoducho meniť alebo pridávať nové. Vytvorte si príjemné funkčné prostredie.

Organise your office, school and work areas. Forget visible cables and unpractical extensions. The elegant and modern aluminium trunkings offer plenty of space for electrical installations. Switches, sockets and communication elements are easily accessible and available in the right place to be used. They can be easily adapted or upgraded. Arrange a pleasant and functional environment for yourself.

modularita

modularity

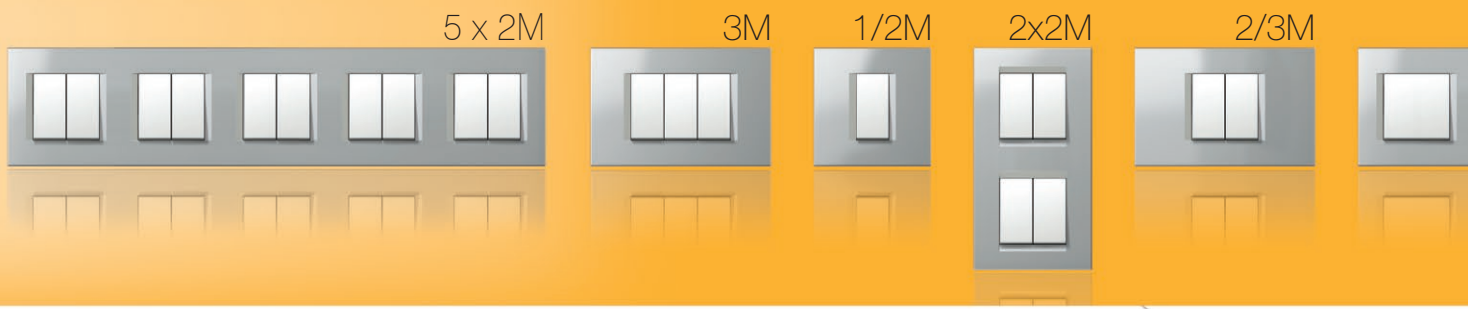

Navrhli sme komplexný systém, ktorý ponúka rad prvkov umožňujúcich vytvoriť si ľubovoľnú konfiguráciu podľa svojich predstáv. Základné prvky systému sú moduly a môžu byť kombinované horizontálne alebo vertikálne.

We have designed a comprehensive system that features a variety of elements, allowing you to create any configuration you wish. The basic elements of the system are modular and can be combined horizontally or vertically.



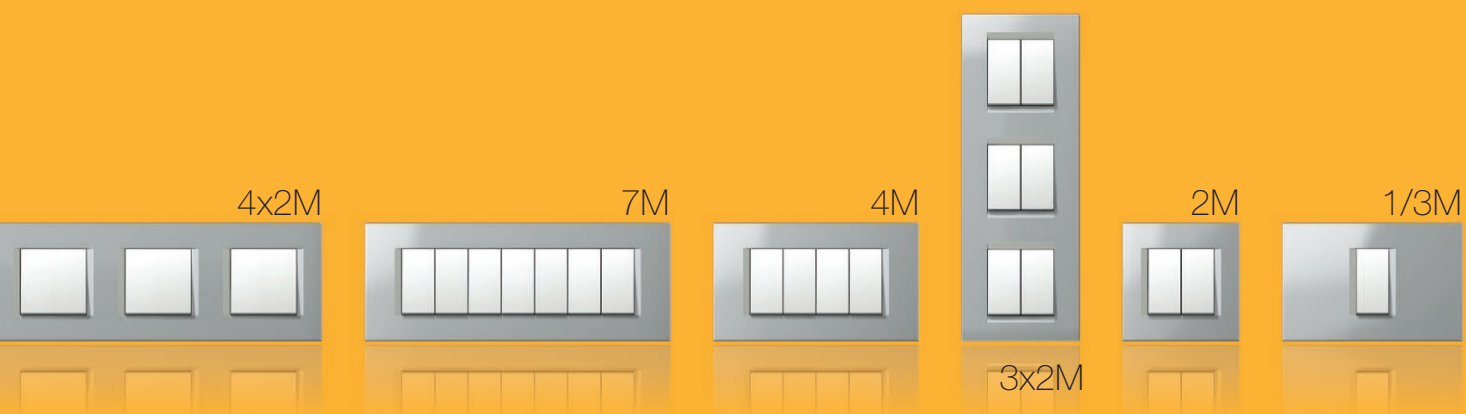

$$1M = \text{[rectangle]}$$

$$2M = \text{[rectangle]} \text{ [rectangle]} = \text{[square]}$$

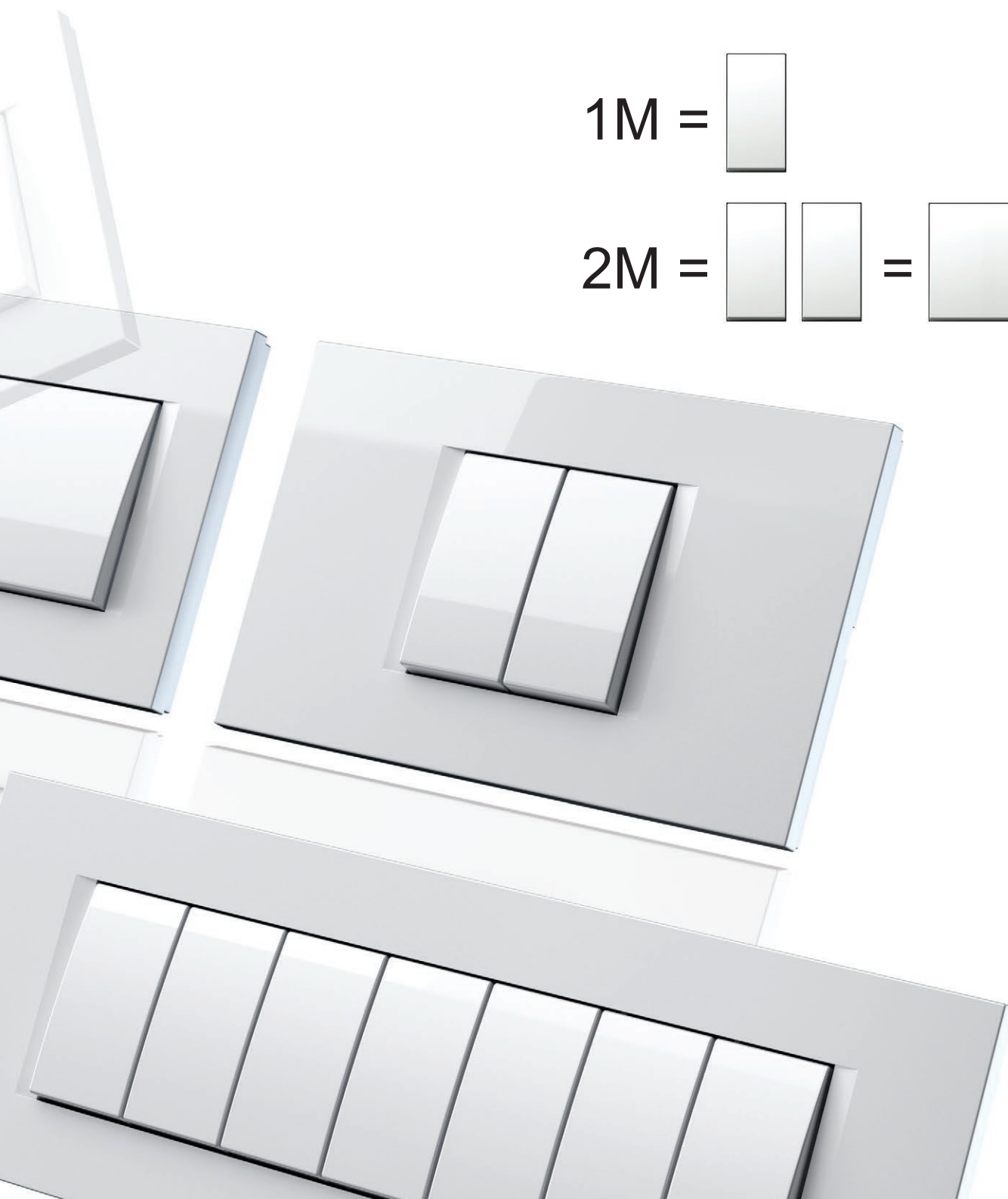

univerzálnosť

universality

System ponúka široký výber prvkov s jednoduchou inštaláciou. Súpravy spínačov môžete inštalovať rôznymi spôsobmi, bez ohľadu na to, či je krabica kruhová alebo obdĺžniková, samostatná alebo v skupine.

The system features a comprehensive selection of elements and is easy to install. Switch sets can be positioned in many different ways, regardless of whether the box is round or rectangular, individual or serial.

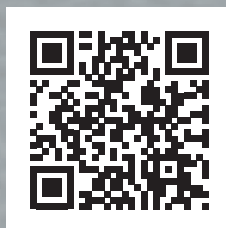

modulmanager.tem.si

Vyskúšajte "ModulManager", ktorý vám umožní ľahko zostaviť ľubovoľnú kombináciu.

Try out the "ModulManager" tool, which will help you put together any combination you want.

riešenie pre 4 spínače

solutions for 4 switches

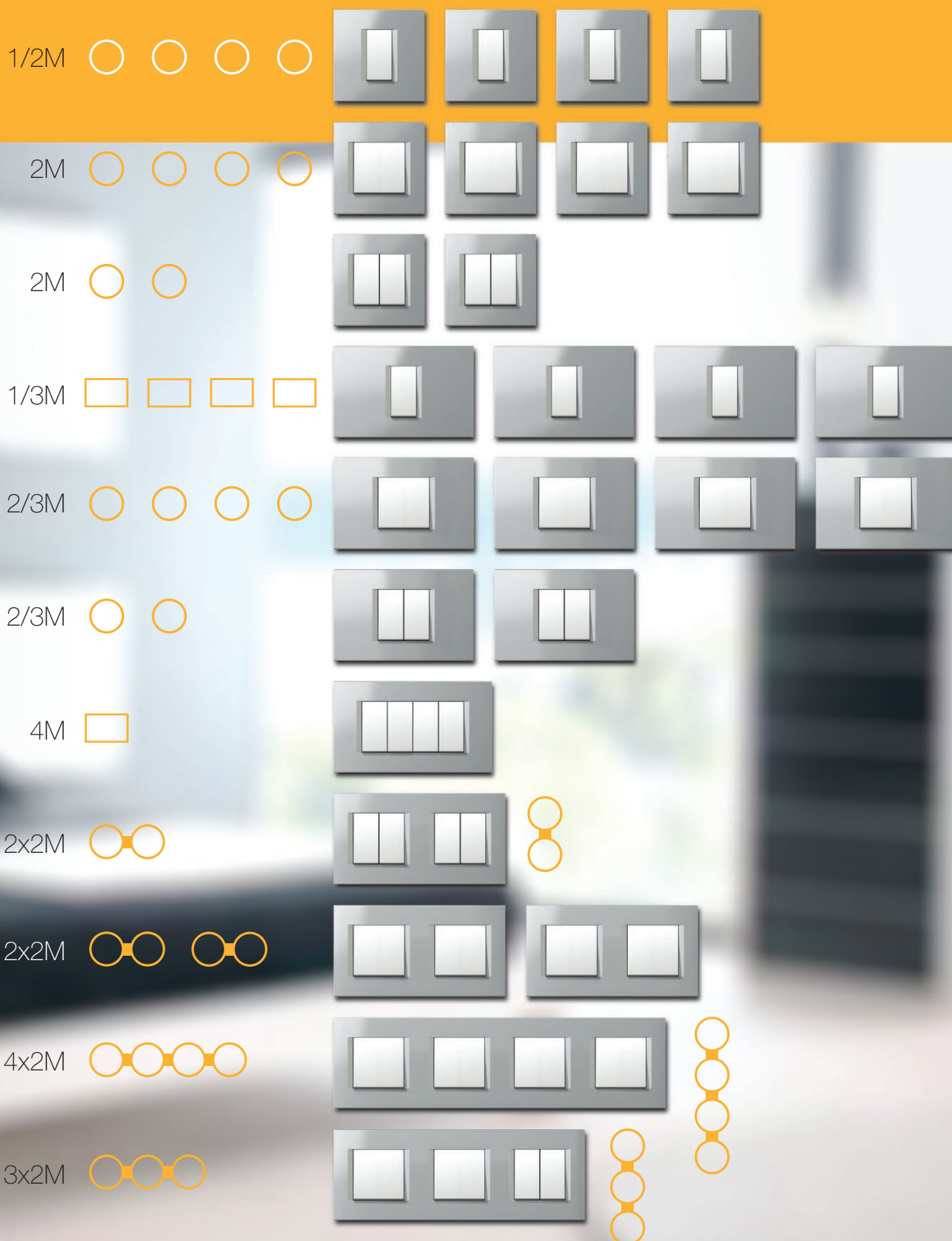

MODUL MANAGER

jednoduchý a rychlý / easy and fast





konfigurátor spínačov a zásuviek

configurator of switches and sockets

Modul Manager umožňuje spracovať kompletný a rýchly súpis spínačov priamo na stavenisku alebo z pohodlia vášho domova. Pripravili sme pre vás jedinečný spôsob objednávania, ktorý je praktický a rýchly. Môžete si vybrať farby spínačov, rovnako ako tvar rámov a prispôbiť ich svojmu priestoru alebo požiadavkám klienta. Prečo si nás nevyskúšať? Všetko, čo potrebujete, je dotykový telefón, tablet alebo počítač a <http://modulmanager.tem.si>.

The Modul Manager allows you to perform a complete and quick inventory of switches from the building site itself or from the comfort of your own home. We have prepared a unique ordering method, which is both practical and quick. You can select the colours of the switches, as well as the shape of the frames, meaning you can tailor them to your space or the client's demands. Why not try us out? All you need is a smartphone, a tablet, or a computer and <http://modulmanager.tem.si>.

funkčnosť

functionality

Modul bol vyvinutý pre tých, ktorí ocenia premyslene navrhnutý výrobok. Systém zaberá menej miesta, pretože vo vnútri jedného rámičku môže byť nainštalovaná akákoľvek kombinácia funkčných prvkov. Je vhodný do nových, ako aj rekonštruovaných objektov.

The Modul was developed for those who can appreciate a thoughtfully designed product. The system takes up less space, as any combination of function elements can be fitted inside the same cover plate. It is suitable for new, as well as renovated buildings.



Modul Soft je dostupný tiež v antibakteriálnom riešení AW.

The Modul Soft is also available in an antibacterial solution AW.

dekoratívne rámičky
decorative cover plates

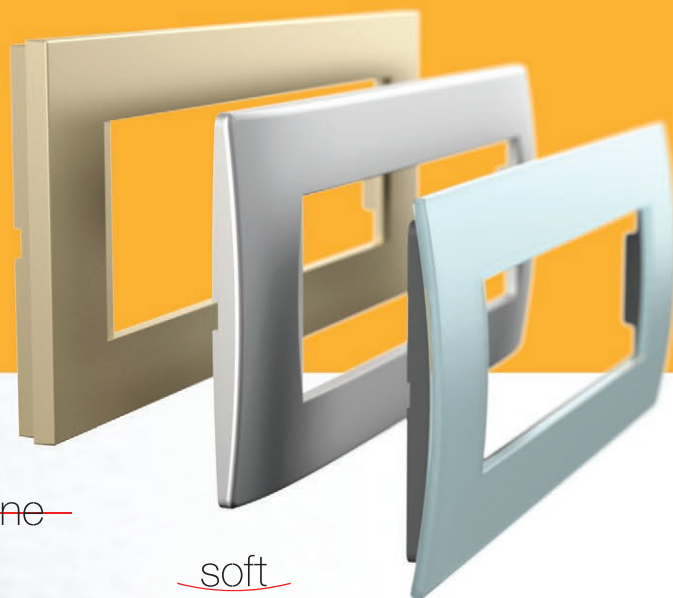

—line—

—soft—

PURE



funkčné prvky
function elements



jednoduchosť simplicity

Funkčné prvky je možné ľahko namontovať do montážneho rámu. Vyvinuli sme pre vás riešenie typu „klik-in, klik-out“, aby sme vám skrátili celkovú dobu montáže. Pripojovacie kontakty sú ľahko prístupné z prednej strany.

The function elements are easily fitted inside the mounting frame. The “klik-in, klik-out” solution we have developed for you will reduce installation time. The connection contacts are easily accessible from the front.

line
soft
PURE

klik-in, klik-out

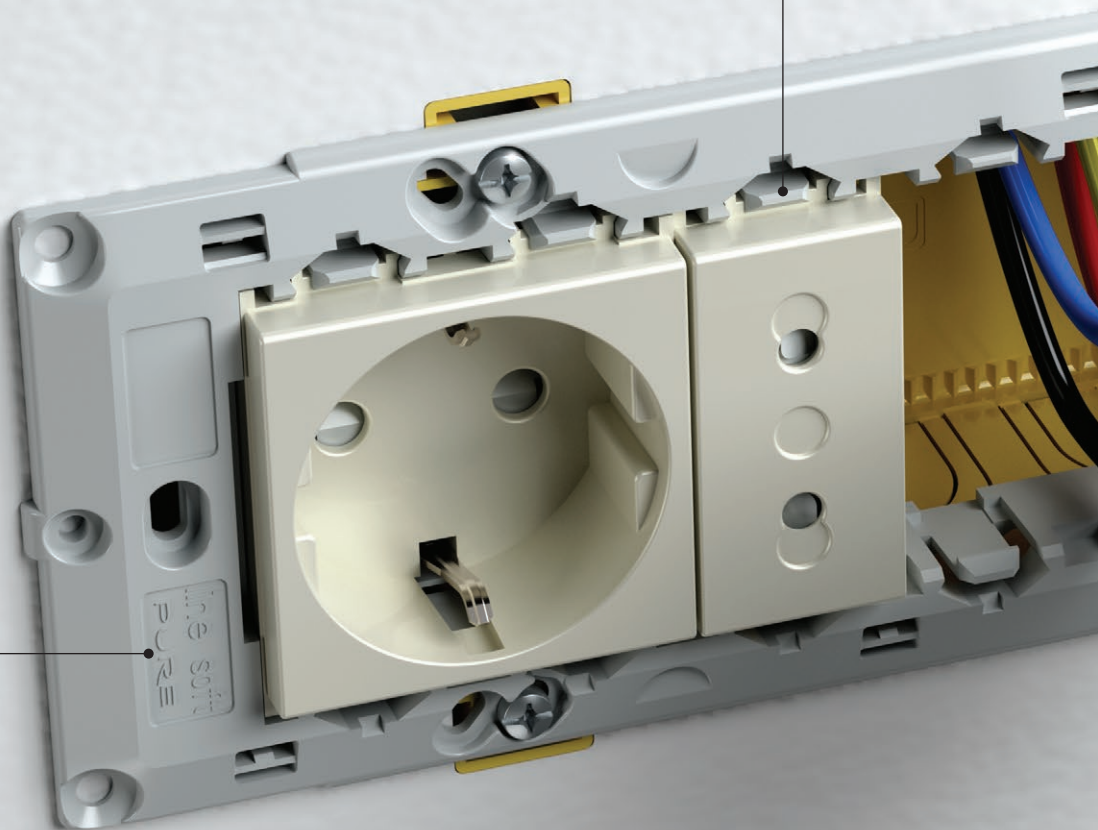

„Klik out“ – kliknutím otvorí, jednoduchý a rýchly spôsob bez skrútkovania.

“klik-out” - simple and quick, no screws necessary.

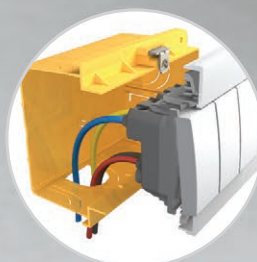

Obdĺžnikové krabice poskytujú väčší priestor na spojovacie vodiče.

Rectangular boxes have more space for connection wires.

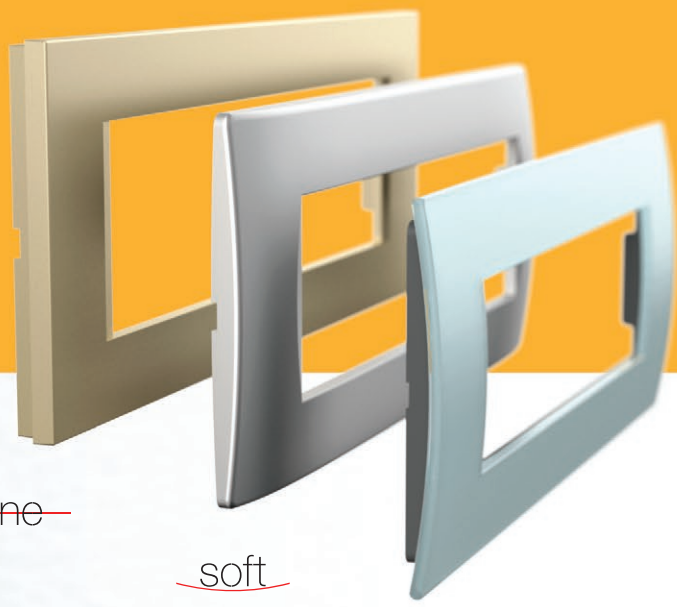
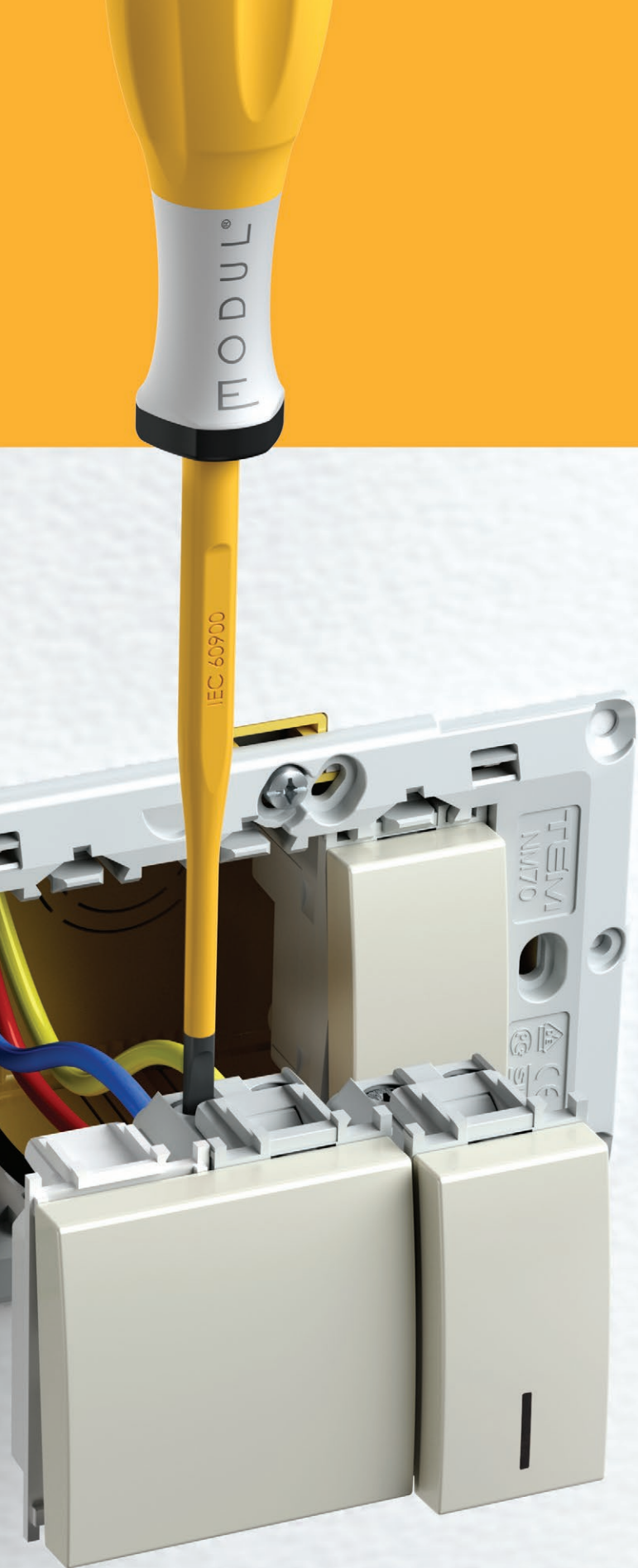

~~line~~

soft

PURE

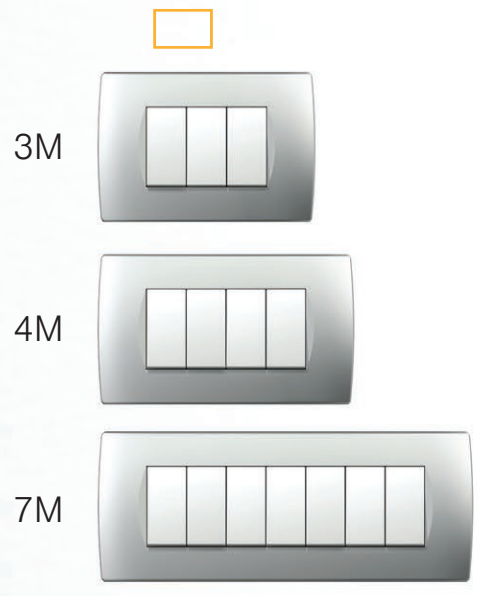

kombinovateľnosť

combinability

Modul ponúka veľa možností, dokonca aj pri okrúhlych krabiciach. Možno ich kombinovať vodorovne alebo zvisle, jednotlivu alebo v skupinách. Kovový montážny rám zaručuje výbornú stabilitu aj pri drsnom používaní a je vhodný pre všetky dekoratívne rámy.

The Modul enables a many possibilities even with round boxes. You can combine them horizontally or vertically, individually or in groups. The metal mounting frame ensures excellent stability even with rough use and is suitable for any decorative cover plates.

line
soft
PURE

klik-in, klik-out

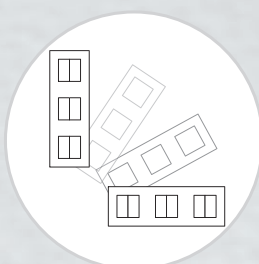
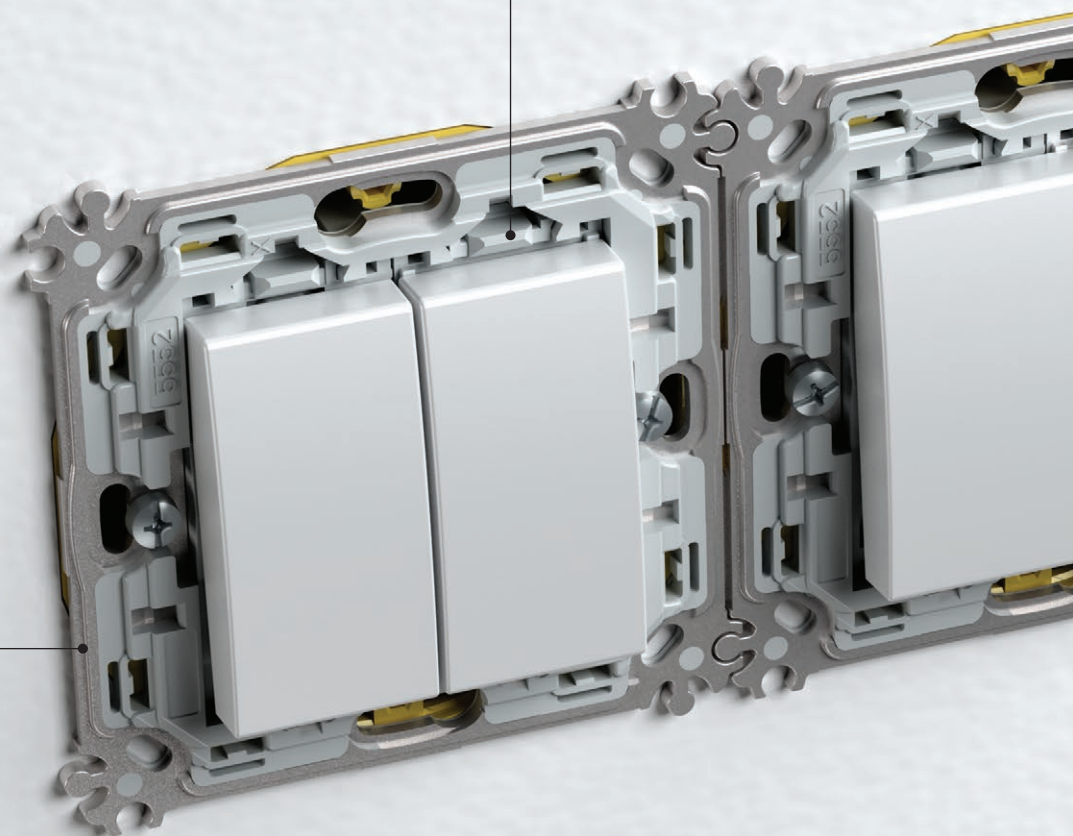

Každý rámik môže byť umiestnený vodorovne, ale aj zvislo.

The same cover plate can be positioned horizontally or vertically.

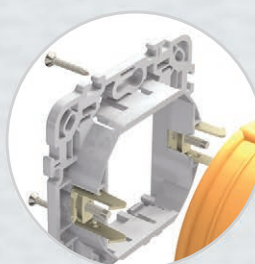

Montážne rámy možno upevniť pomocou skrutiek alebo rozperiek. Mounting frames can be fixed with screws or claws.



~~line~~

~~soft~~

PURE



2M



2x2M



3x2M



4x2M



5x2M



2M montážne rámy sa jednoducho spájajú do skupín.

2M mounting frames are easily joined into groups.

univerzálnost'

universality

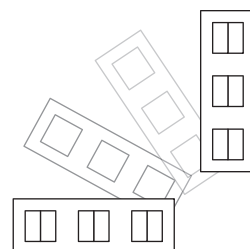
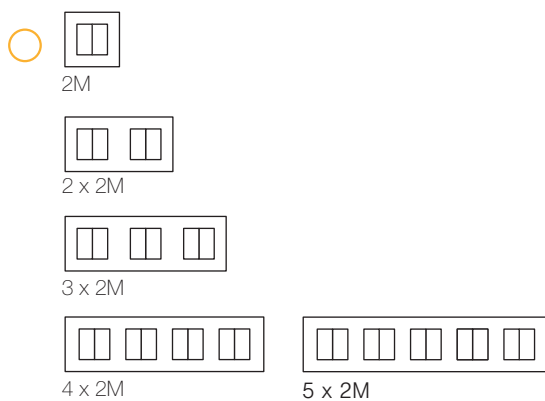
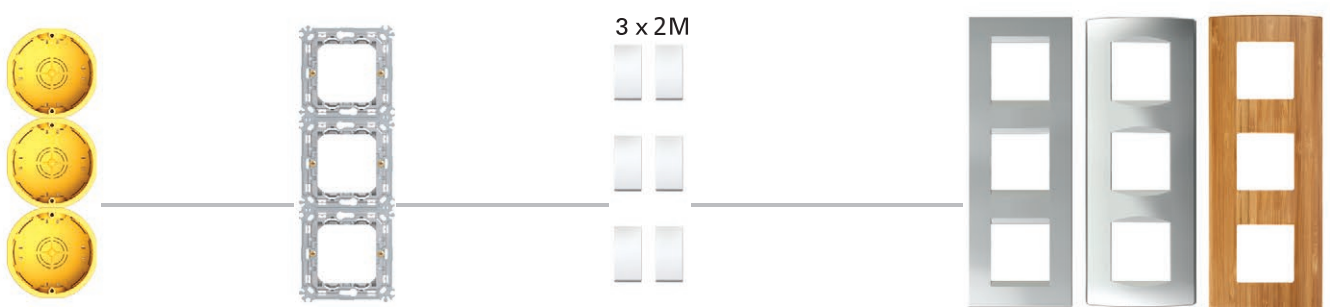
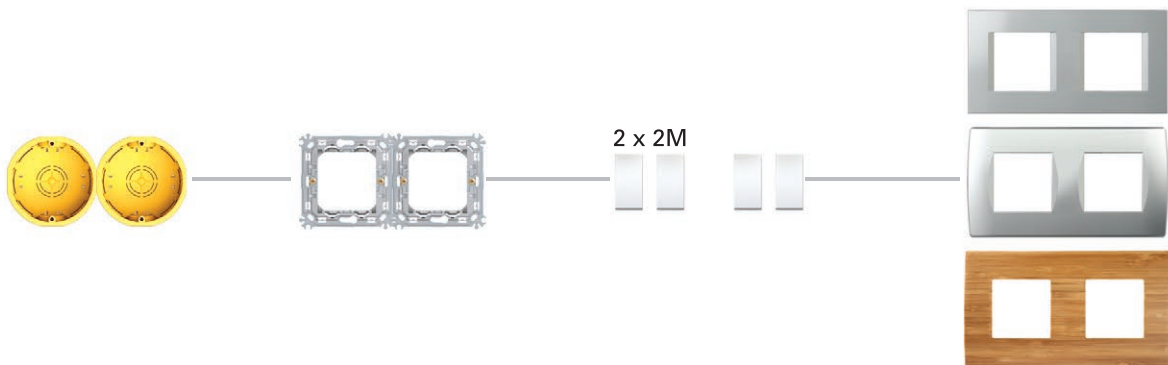
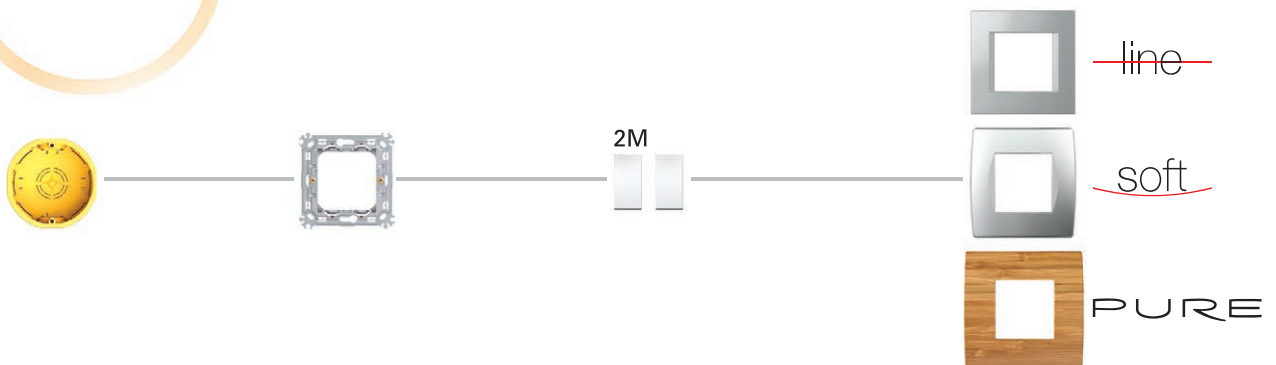

The system is universal and can be fitted in both round and rectangular boxes.

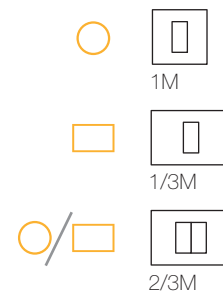
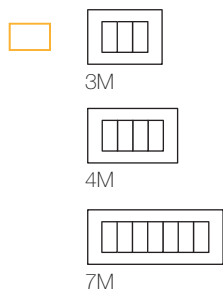
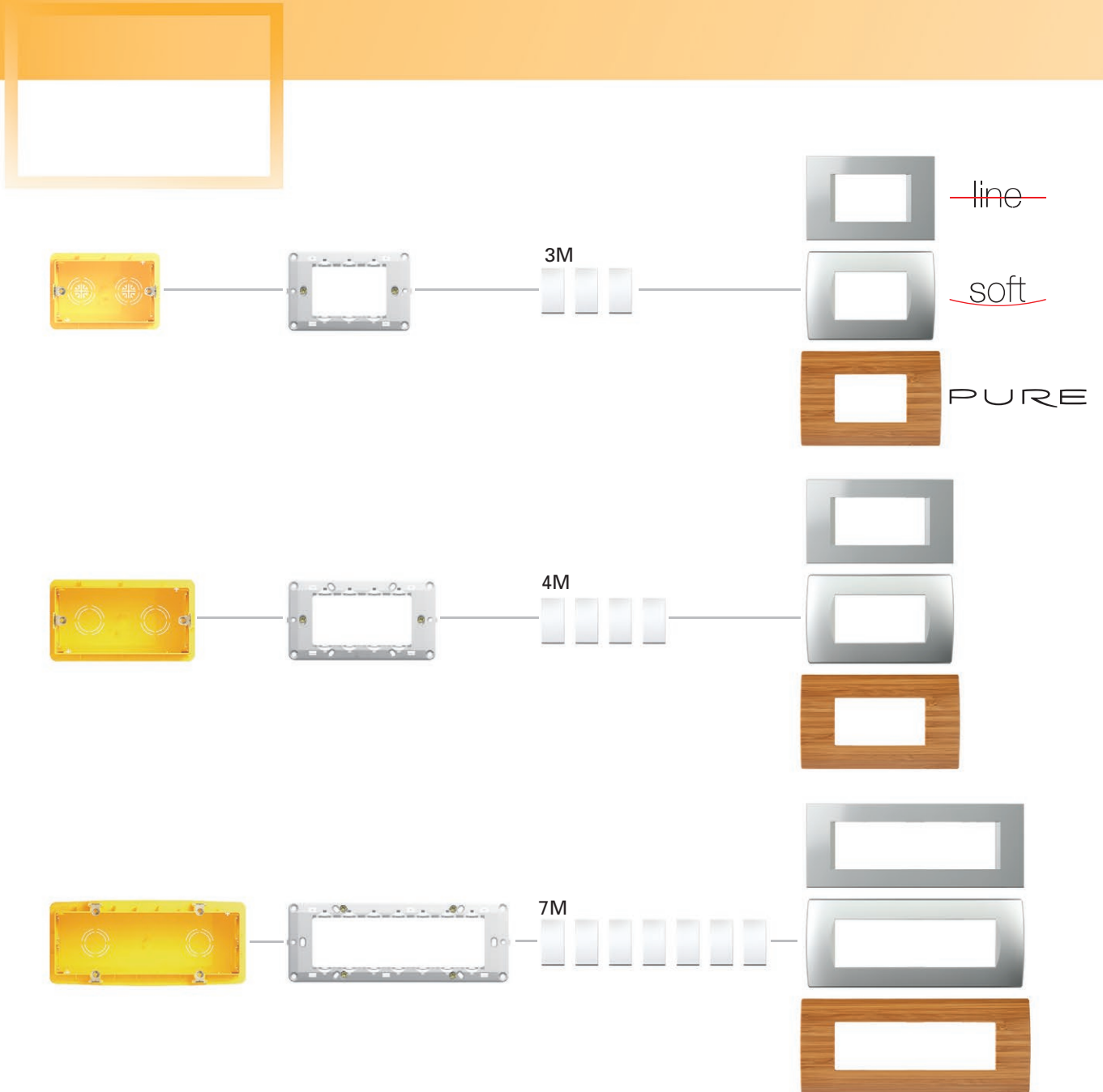

funkčné prvky

function elements

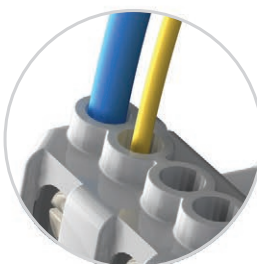
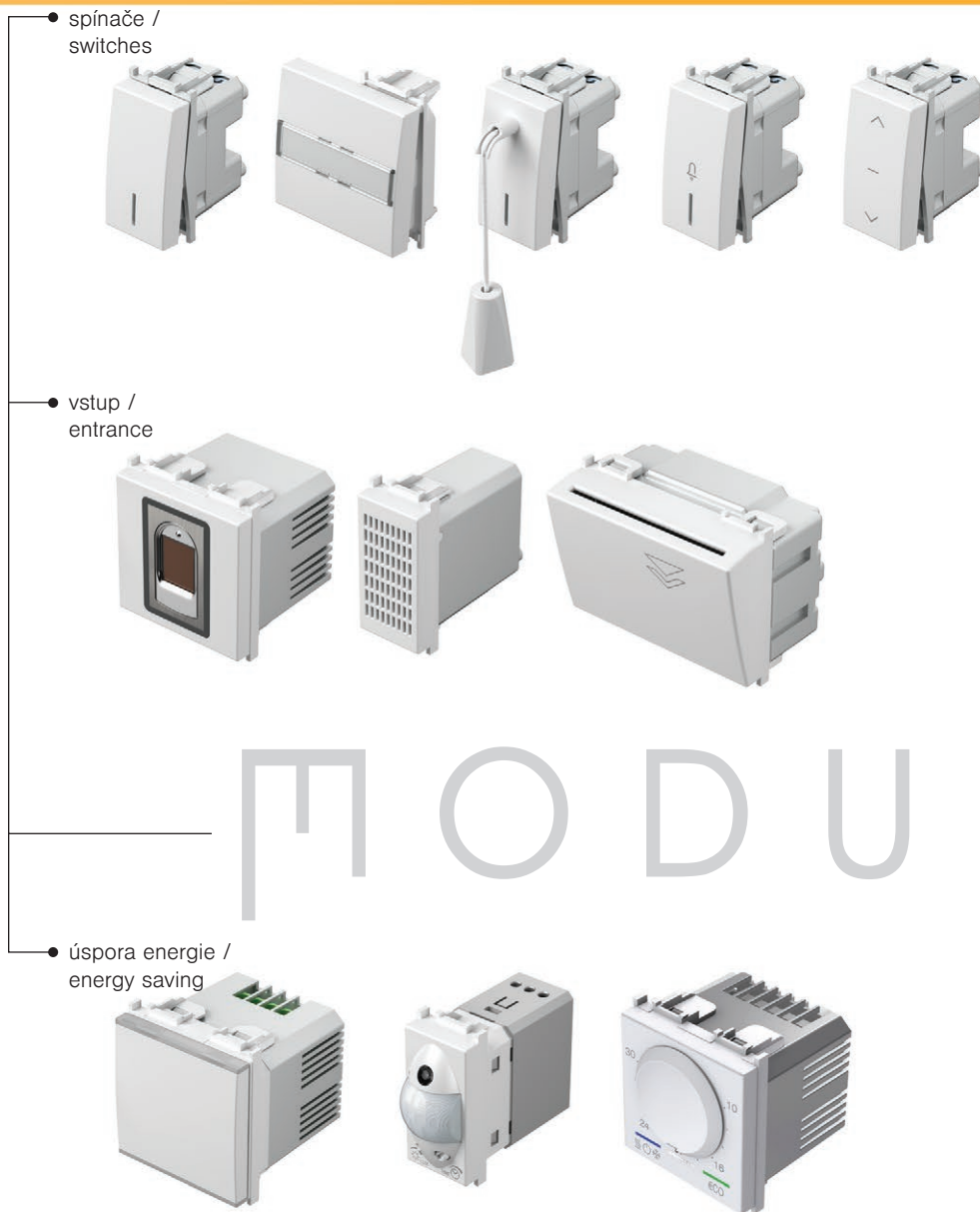

Spofahlivé pripojenie káblov rôznych priemerov.
Reliable connection even when different size of wires are used.



Spínače s dlhou životnosťou, ktorá spĺňa medzinárodné štandardy.
Long-life of switches and adequacy to the international standards.

We have designed a wide selection of function element for the Modul family. You can use them to design both simple and complex installations.



• zásuvky / sockets

• komunikačné prvky / entertainment

• osvetlenie / illumination



Všetky zásuvky sú vybavené bezpečnostnou poistkou zabezpečujúcou ochranu pred dotykom kontaktov pod napätím.

All the sockets are equipped with a safety shutters assuring the protection to live contacts.



16 AX
kontakty

Spínač je vysoko spoľahlivý vďaka svojim strieborným kontaktným nitom.

The switch is highly reliable via its silver rivets contacts.

jedinečný rozsah použiteľnosti

unique range of usability

Modul Soft AW
antibakteriálna verzia /
antibacterial solution



MODUL

CUBO IP20

krabice montované na povrch
surface mounted boxes



CUBO IP55

krabice montované na povrch
surface mounted boxes



IP44

zapustené pod omietku
flush mounted



Zariaďujete si svoj domov, kanceláriu alebo dielňu? Rad Modul je vhodný pre obytné i pracovné priestory, ako aj pre súkromné i verejné budovy. Tento rad je unikátny v tom, že spínače a zásuvky môžu byť namontované kdekoľvek je to potrebné.

Are you furnishing your home, office or workshop? The Modul is suitable for living as well as working spaces and both private and public buildings. It is unique in that the switches and sockets can be fitted wherever they are needed.

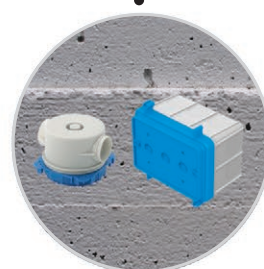
Dtehla
brick**H**dutá stena
hollow wall**B**betón
concrete

• funkčné prvky /
function elements

spínače / switches
zásuvky / sockets
komunikácia / communications
senzory / sensors
regulátory / regulators
osvetlenia / illuminations

MAinštalčné systémy
trunking systems**MO**rozvodné skrine
distribution boards**MT**podlahové krabice
floor boxes

zapustené riešenia

flush mounted solutions

tehla / brick

Rad Modul je vhodný pre všetky typy stien a môže byť použitý v konvenčných, betónových konštrukciách, ale aj v konštrukciách z dutých priečok. Lahko sa inštaluje a umožňuje kombinovať obdĺžnikové alebo okrúhle krabice v správnych vzdialenostiach. Použité materiály sú v súlade s vysokými štandardmi.

The Modul is suitable for all wall types and can be used in conventional, hollow wall or concrete constructions. It is easy to install and enables you to combine rectangular or round boxes at the proper distances. The materials used are compliant with high standards.



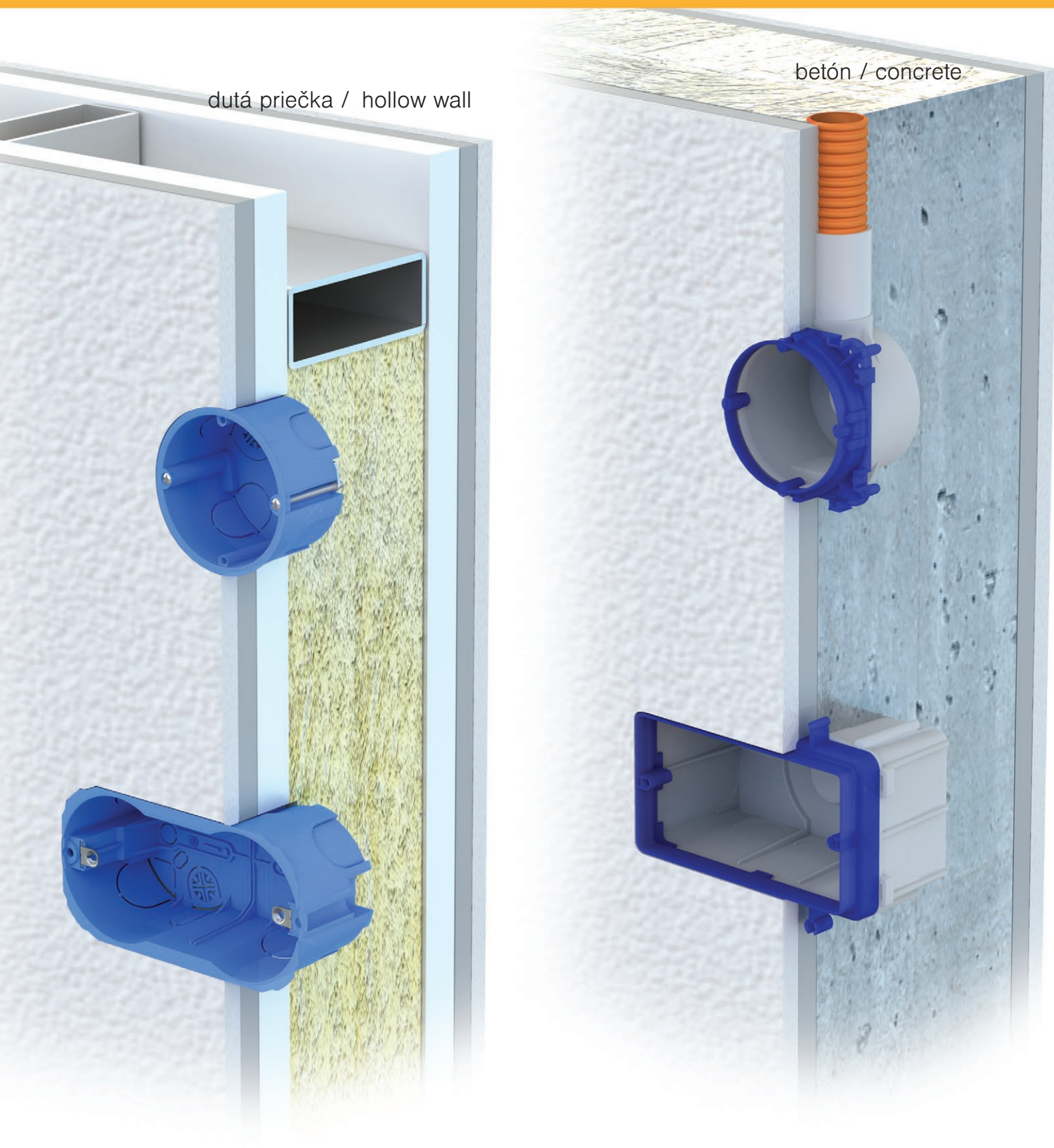

iné riešenia

other solutions

IP44
zapustené pod
omietku
flush mounted

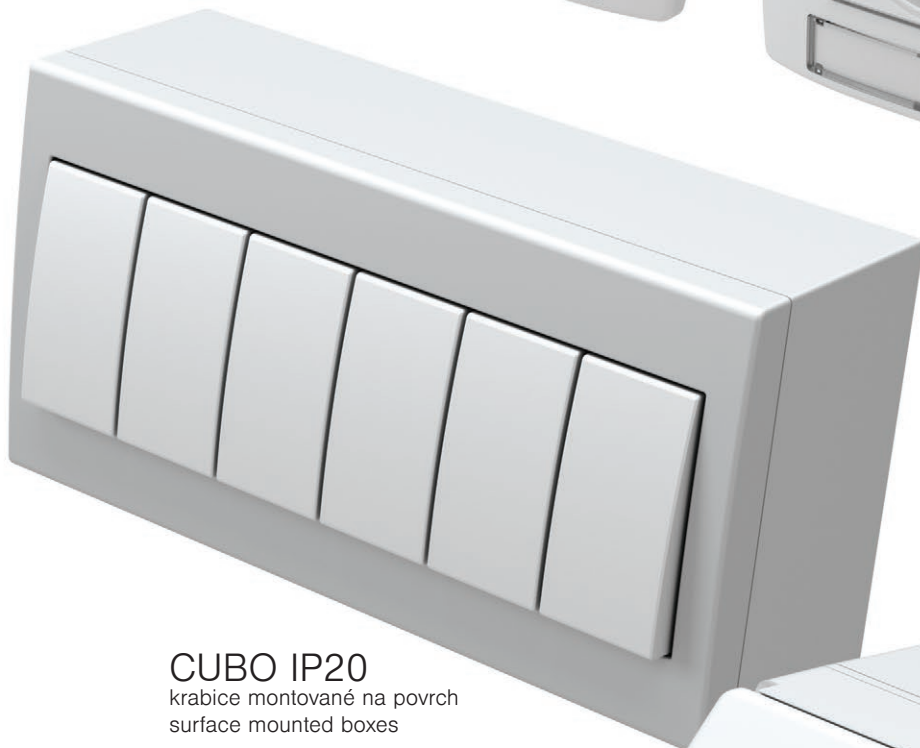

CUBO IP20
krabice montované na povrch
surface mounted boxes

CUBO IP55
krabice montované na povrch
surface mounted boxes



Potrebujete mať spínač alebo zásuvku inštalovanú pod omietkou, na povrchu alebo v podlahe? Rad Modul poskytuje rôzne montážne riešenia s rôznymi triedami ochrany IP pre inšalačné systémy, rozvodné skrine a podlahové krabice. Voľba je len na vás.

Do you need switch or socket in flush, surface or floor solution? The Modul provides different mounting solutions with different IP protections, for trunking systems, distribution boards or floor boxes. The choice is yours.



MA

inštalčné systémy
trunking systems

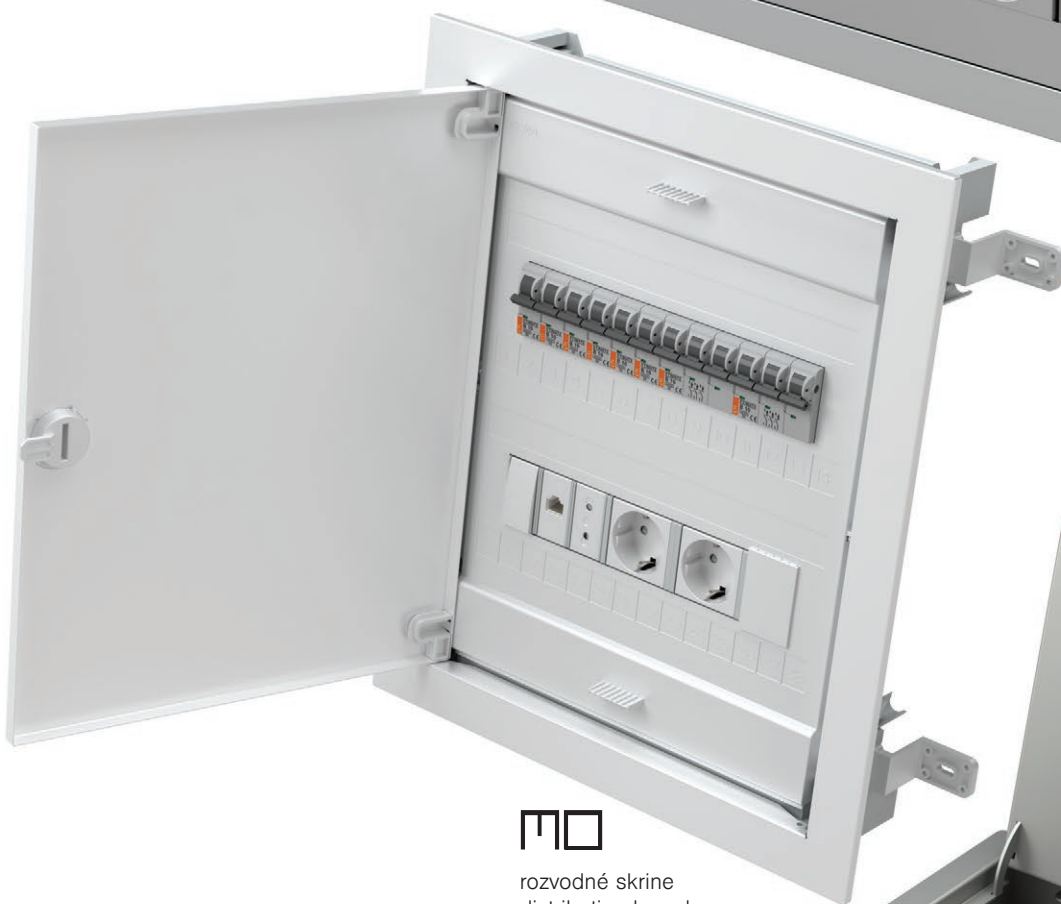

MO

rozvodné skrine
distribution boards

MT
podlahové
krabice
floor boxes



technický katalóg

technical catalogue





MODUL

— funkčné prvky
function elements



66

dizajn
design

PURE
line
soft



116

krabice
boxes



136

distribúcia
distribution



158

ekonomik —



182

fontana —



210

TEM



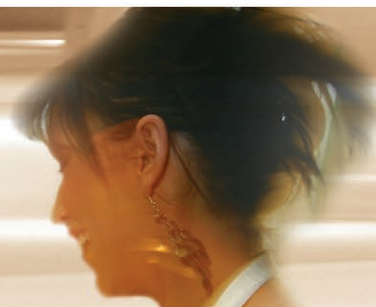

FUNKČNÉ PRVKY

FUNCTION ELEMENTS

SPÍNAČE SM

SWITCHES SM



68

KRYTY TLAČIDIEL TM

BUTTONS TM



73

OSVETLENIE IA

ILLUMINATION IA



76

ZÁSUVKY VM

SOCKETS VM



78

KOMUNIKAČNÉ PRVKY KM

COMMUNICATIONS KM



82

KOMUNIKAČNÉ PRÍSLUŠENSTVO KA

COMMUNICATION ACCESSORIES KA



88

ELEKTRONIKA EM

ELECTRONICS EM



91

SÚPRAVY CM

SETS CM



110

ANTIBAKTERIÁLNY PROGRAM AW

ANTIBACTERIAL PROGRAM AW



115

DIZAJN

DESIGN

RÁMIKY PURE OP

COVER PLATES PURE OP



120

RÁMIKY LINE OL

COVER PLATES LINE OL



124

RÁMIKY SOFT OS

COVER PLATES SOFT OS



128

MONTÁŽNE RÁMY NM

MOUNTING FRAMES NM



134

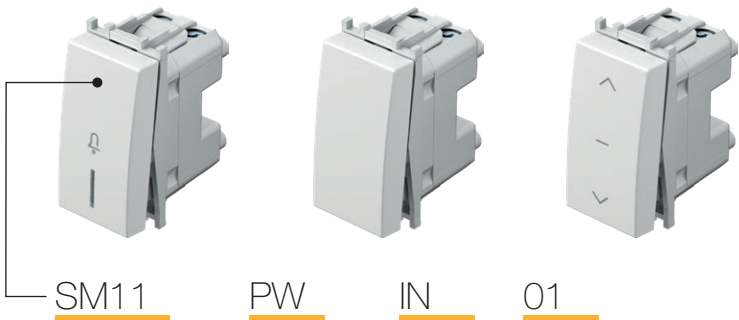

typ type	popis description	technické dáta technical data	veľkosť size	farba colour	voliteľné údaje 1 optional data 1	voliteľné údaje 2 optional data 2
SM10	SPÍNAČ JEDNOPÓLOVÝ SWITCH 1WAY	16AX 250V~	1M	<input type="checkbox"/> PW <i>polárna biela polar white</i>	<input type="checkbox"/> NT <i>neutrálna neutral</i>	O1
SM11	TLAČIDLO JEDNOPÓLOVÉ PUSH BUTTON 1WAY	16A 250V~	1M	<input checked="" type="checkbox"/> SB <i>čierna matná zamatová soft touch black</i>	<input type="checkbox"/> IN <i>neutrálna indicator</i>	O2
SM12	SPÍNAČ JEDNOPÓLOVÝ SWITCH 1WAY	20A 250V~	1M	<input checked="" type="checkbox"/> AT <i>antracit anthracite</i>		O3
⋮	⋮	⋮	⋮	<input type="checkbox"/> ES <i>čierna matná zamatová elox silver</i>		
⋮	⋮	⋮	⋮	<input checked="" type="checkbox"/> IW <i>slonová kosť ivory white</i>		

SPÍNAČ JEDNOPÓLOVÝ 16 AX 250 V ~ 1M



SM10

- spínač bez krytu tlačidla
- 16 AX 250 V ~, typ SM10
- v súlade s normou EN 60669-1
- skrutkové upevnenie vodičov 1,5 – 2,5 mm²

SWITCH 1WAY 16AX 250V~ 1M

- switch without button
- 16AX 250V~, type SM10
- in accordance with EN 60669-1
- screw contacts 1.5-2.5mm²

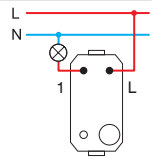

TLAČIDLO JEDNOPÓLOVÉ 16 AX 250 V ~ 1M

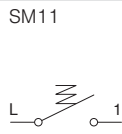

SM11

- tlačidlový spínač bez krytu tlačidla
- 16 A 250 V ~, typ SM11
- v súlade s normou EN 60669-1
- skrutkové upevnenie vodičov 1,5 – 2,5 mm²

PUSH BUTTON 1WAY 16A 250V~ 1M

- push button without button
- 16A 250V~, type SM11
- in accordance with EN 60669-1
- screw contacts 1.5-2.5mm²

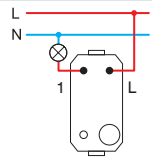

SPÍNAČ JEDNOPÓLOVÝ 20 A 250 V ~ 1M



SM12

- spínač bez krytu tlačidla
- 20A 250 V ~, typ SM12
- v súlade s normou EN 60669-1
- skrutkové upevnenie vodičov 1,5 – 2,5 mm²

SWITCH 1WAY 20A 250V~ 1M

- switch without button
- 20A 250V~, type SM12
- in accordance with EN 60669-1
- screw contacts 1.5-2.5mm²

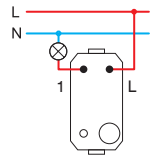

SPÍNAČ DVOJPÓLOVÝ 16 AX 250 V ~ 1M

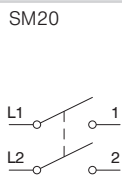

SM20

- spínač bez krytu tlačidla
- 16 AX 250 V ~, typ SM20
- v súlade s normou EN 60669-1
- skrutkové upevnenie vodičov 1,5 – 2,5 mm²
- len v kombinácii s tlačidlom TM15

SWITCH 2POLE 16AX 250V~ 1M

- switch without button
- 16AX 250V~, type SM20
- in accordance with EN 60669-1
- screw contacts 1.5-2.5mm²
- only in combination with button TM15

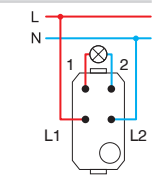



SM40

ŽALÚZIOVÝ SPÍNAČ 1-0-2 16 AX 250 V ~ 1M

- spínač bez krytu tlačidla
- 16 AX 250 V ~, typ SM40
- v súlade s normou EN 60669-1
- skrutkové upevnenie vodičov 1,5 – 2,5 mm²

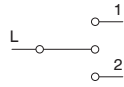

SWITCH SHUTTERS 1-0-2 16AX 250V~ 1M

- switch without button
- 16AX 250V~, type SM40
- in accordance with EN 60669-1
- screw contacts 1.5-2.5mm²

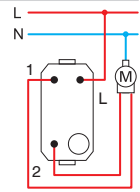

SM41

ŽALÚZIOVÉ TLAČIDLO 1-0-2 16 A 250 V ~ 1M

- tlačidlový spínač bez krytu tlačidla
- 16 A 250 V ~, typ SM41
- v súlade s normou EN 60669-1
- skrutkové upevnenie vodičov 1,5 – 2,5 mm²

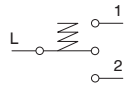

PUSH BUTTON SHUTTERS 1-0-2 16A 250V~ 1M

- push button without button
- 16A 250V~, type SM41
- in accordance with EN 60669-1
- screw contacts 1.5-2.5mm²

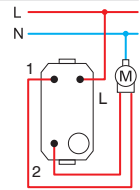

SM60

STRIEDAVÝ PREPÍNAČ 16 AX 250 V ~ 1M

- prepínač bez krytu tlačidla
- 16 AX 250 V ~, typ SM60
- v súlade s normou EN 60669-1
- skrutkové upevnenie vodičov 1,5 – 2,5 mm²

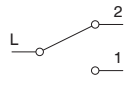

SWITCH 2WAY 16AX 250V~ 1M

- switch without button
- 16AX 250V~, type SM60
- in accordance with EN 60669-1
- screw contacts 1.5-2.5mm²

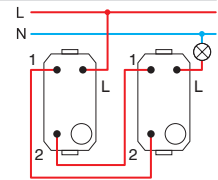

SM61

STRIEDAVÉ TLAČIDLO 16 A 250 V ~ 1M

- tlačidlový prepínač bez krytu tlačidla
- 16 A 250 V ~, typ SM61
- v súlade s normou EN 60669-1
- skrutkové upevnenie vodičov 1,5 – 2,5 mm²

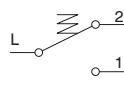

PUSH BUTTON 2WAY 16A 250V~ 1M

- push button without button
- 16A 250V~, type SM61
- in accordance with EN 60669-1
- screw contacts 1.5-2.5mm²

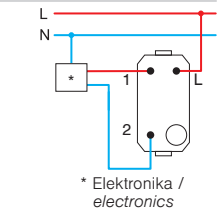

* Elektronika / electronics



SM70

KRÍŽOVÝ PREPÍNAČ 16 AX 250 V ~ 1M

- prepínač bez krytu tlačidla
- 16 AX 250 V ~, typ SM70
- v súlade s normou EN 60669-1
- skrutkové upevnenie vodičov 1,5 – 2,5 mm²

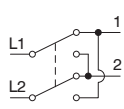

SWITCH INTERMEDIATE 16AX 250V~ 1M

- switch without button
- 16AX 250V~, type SM70
- in accordance with EN 60669-1
- screw contacts 1.5-2.5mm²

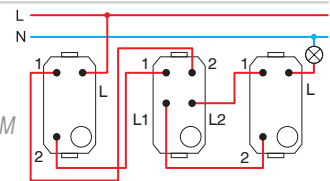

1M = 22,5 x 45
2M = 45 x 45

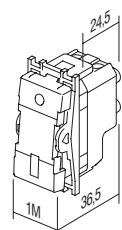
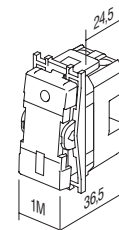



□ PW polárna biela
polar white



■ SB čierna matná zamatová
soft touch black



■ AT antracit
anthracite



□ ES strieborná matná
elox silver



□ IW slonová kosť
ivory white

SPÍNACĚ JEDNOPÓLOVÝ 16 AX 250 V ~ 1M



- SM10PW
- SM10SB
- SM10AT
- SM10ES
- SM10IW

- 16 AX 250 V ~, typ SM10
- v súlade s normou EN 60669-1
- skrutkové upevnenie vodičov 1,5 – 2,5 mm²
- vymeniteľný kryt tlačidla

SWITCH 1WAY 16AX 250V~ 1M

- 16AX 250V~, type SM10
- in accordance with EN 60669-1
- screw contacts 1.5-2.5 mm²
- replaceable button



SPÍNACĚ JEDNOPÓLOVÝ 16 AX 250 V ~ 1M __ IN



- SM10PWIN
- SM10SBIN
- SM10ATIN
- SM10ESIN
- SM10IWIN

- indikátor IN
- 16 AX 250 V ~, typ SM10
- v súlade s normou EN 60669-1
- skrutkové upevnenie vodičov 1,5 – 2,5 mm²
- svetelný zdroj nie je zahrnutý
- vymeniteľný kryt tlačidla

SWITCH 1WAY 16AX 250V~ 1M __ IN

- IN indicator
- 16AX 250V~, type SM10
- in accordance with EN 60669-1
- screw contacts 1.5-2.5 mm²
- lamp is not included
- replaceable button



TLAČIDLO JEDNOPÓLOVÉ 16 A 250 V ~ 1M



- SM11PW
- SM11SB
- SM11AT
- SM11ES
- SM11IW

- 16 A 250 V ~, typ SM11
- v súlade s normou EN 60669-1
- skrutkové upevnenie vodičov 1,5 – 2,5 mm²
- vymeniteľný kryt tlačidla

PUSH BUTTON 1WAY 16A 250V~ 1M

- 16A 250V~, type SM11
- in accordance with EN 60669-1
- screw contacts 1.5-2.5 mm²
- replaceable button



TLAČIDLO JEDNOPÓLOVÉ 16 A 250 V ~ 1M __ IN 01



- SM11PWIN01
- SM11SBIN01
- SM11ATIN01
- SM11ESIN01
- SM11IWIN01

- zvonček indikátora IN 01
- 16 A 250 V ~, typ SM11
- v súlade s normou EN 60669-1
- skrutkové upevnenie vodičov 1,5 – 2,5 mm²
- svetelný zdroj nie je zahrnutý
- vymeniteľný kryt tlačidla

PUSH BUTTON 1WAY 16A 250V~ 1M __ IN 01

- IN 01 indicator bell
- 16A 250V~, type SM11
- in accordance with EN 60669-1
- screw contacts 1.5-2.5 mm²
- lamp is not included
- replaceable button



TLAČIDLO JEDNOPÓLOVÉ 16 A 250 V ~ 1M __ IN 02



- SM11PWIN02 - svetelný indikátor IN 02
- SM11SBIN02 - 16 A 250 V ~, typ SM11
- SM11ATIN02 - v súlade s normou EN 60669-1
- SM11ESIN02 - skrutkové upevnenie vodičov 1,5 – 2,5 mm²
- SM11WIN02 - svetelný zdroj nie je zahrnutý
- SM11WIN02 - vymeniteľný kryt tlačidla

PUSH BUTTON 1WAY 16A 250V~ 1M __ IN 02

- IN 02 indicator light
- 16A 250V~, type SM11
- in accordance with EN 60669-1
- screw contacts 1.5-2.5 mm²
- lamp is not included
- replaceable button



SPÍNAČ DVOJPÓLOVÝ 16 AX 250 V ~ 1M __ IN 03



- SM20PWNT03 - neutrál NT 03 0-1
- SM20SBNT03 - 16 AX 250 V ~, typ SM20
- SM20ATNT03 - v súlade s normou EN 60669-1
- SM20ESNT03 - skrutkové upevnenie vodičov 1,5 – 2,5 mm²
- SM20IWNTO3 - vymeniteľný kryt tlačidla

SWITCH 2POLE 16AX 250V~ 1M __ NT 03

- NT 03 neutral 0-1
- 16AX 250V~, type SM20
- in accordance with EN 60669-1
- screw contacts 1.5-2.5 mm²
- replaceable button



SPÍNAČ DVOJPÓLOVÝ 16 AX 250 V ~ 1M __ IN



- SM20PWIN - indikátor IN
- SM20SBIN - 16 AX 250 V ~, typ SM20
- SM20ATIN - v súlade s normou EN 60669-1
- SM20ESIN - skrutkové upevnenie vodičov 1,5 – 2,5 mm²
- SM20IWIN - svetelný zdroj nie je zahrnutý
- SM20IWIN - vymeniteľný kryt tlačidla

SWITCH 2POLE 16AX 250V~ 1M __ IN

- IN indicator
- 16AX 250V~, type SM20
- in accordance with EN 60669-1
- screw contacts 1.5-2.5 mm²
- lamp is not included
- replaceable button



ŽALÚZIOVÝ SPÍNAČ 1-0-2 16 AX 250 V ~ 1M __ NT 10

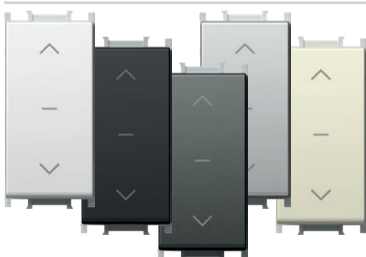

- SM40PWNT10 - neutrál NT 10 1-0-2
- SM40SBNT10 - 16 AX 250 V ~, typ SM40
- SM40ATNT10 - v súlade s normou EN 60669-1
- SM40ESNT10 - skrutkové upevnenie vodičov 1,5 – 2,5 mm²
- SM40IWNTO3 - vymeniteľný kryt tlačidla

SWITCH SHUTTERS 1-0-2 16AX 250V~ 1M __ NT 10

- NT 10 neutral 1-0-2
- 16AX 250V~, type SM40
- in accordance with EN 60669-1
- screw contacts 1.5-2.5mm²
- replaceable button



ŽALÚZIOVÉ TLAČIDLO 1-0-2 16 A 250 V ~ 1M __ NT 10

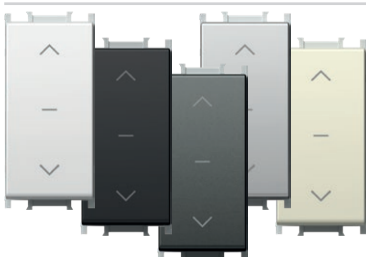

- SM41PWNT10 - neutrál NT 10 1-0-2
- SM41SBNT10 - 16 A 250 V ~, typ SM41
- SM41ATNT10 - v súlade s normou EN 60669-1
- SM41ESNT10 - skrutkové upevnenie vodičov 1,5 – 2,5 mm²
- SM41IWNTO3 - vymeniteľný kryt tlačidla

PUSH BUTTON SHUTTERS 1-0-2 16A 250V~ 1M __ NT 10

- NT 10 neutral 1-0-2
- 16A 250V~, type SM41
- in accordance with EN 60669-1
- screw contacts 1.5-2.5mm²
- replaceable button



STRIEDAVÝ PREPÍNAČ 16 AX 250 V ~ 1M



- SM60PW - 16 AX 250 V ~, typ SM60
- SM60SB - v súlade s normou EN 60669-1
- SM60AT - skrutkové upevnenie vodičov 1,5 – 2,5 mm²
- SM60ES - vymeniteľný kryt tlačidla
- SM60IW

SWITCH 2WAY 16AX 250V~ 1M

- 16AX 250V~, type SM60
- in accordance with EN 60669-1
- screw contacts 1.5-2.5 mm²
- replaceable button





- SM61PW
- SM61SB
- SM61AT
- SM61ES
- SM61IW

STRIEDAVÉ TLAČIDLO 16 A 250 V ~ 1M

- 16 A 250 V ~, typ SM61
- v súlade s normou EN 60669-1
- skrutkové upevnenie vodičov 1,5 – 2,5 mm²
- vymeniteľný kryt tlačidla

PUSH BUTTON 2WAY 16A 250V~ 1M

- 16A 250V~, type SM61
- in accordance with EN 60669-1
- screw contacts 1.5-2.5 mm²
- replaceable button



- SM62PWCD
- SM62SBCD
- SM62ATCD
- SM62ESCD
- SM62IWCD

STRIEDAVÉ TLAČIDLO S TIAHLOM 16 A 250 V ~ 1M __ CD

- indikátor CD + kábel
- dĺžka tiahla 1,5 m
- 16 A 250 V ~, typ SM62
- v súlade s normou EN 60669-1
- skrutkové upevnenie vodičov 1,5 – 2,5 mm²

PUSH BUTTON 2WAY WITH CORD 16A 250V~ 1M __ CD

- CD indicator+cord
- cord length 1.5m
- 16A 250V~, type SM62
- in accordance with EN 60669-1
- screw contacts 1.5-2.5 mm²



- SM70PW
- SM70SB
- SM70AT
- SM70ES
- SM70IW

KRÍŽOVÝ PREPÍNAČ 16 AX 250 V ~ 1M

- 16 AX 250 V ~, typ SM70
- v súlade s normou EN 60669-1
- skrutkové upevnenie vodičov 1,5 – 2,5 mm²
- vymeniteľný kryt tlačidla

SWITCH INTERMEDIATE 16AX 250V~ 1M

- 16AX 250V~, type SM70
- in accordance with EN 60669-1
- screw contacts 1.5-2.5 mm²
- replaceable button



1M = 22,5 x 45
2M = 45 x 45

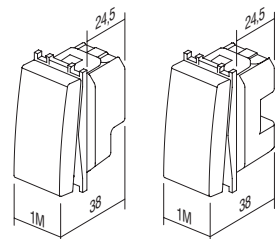

B U T T O N S T M

typ type	popis description	veľkosť size	farba colour	voliteľné údaje 1 optional data 1	voliteľné údaje 2 optional data 2
TM11	KRYT TLAČIDLA BUTTON	1M	<input type="checkbox"/> PW polárna biela polar white	<input type="checkbox"/> NT neutrálna neutral	01
TM12	KRYT TLAČIDLA BUTTON	2M	<input checked="" type="checkbox"/> SB čierna matná zamatová soft touch black	<input type="checkbox"/> IN indikátor indicator	02
TM21	VÝPLŇ BLANK	1M	<input checked="" type="checkbox"/> AT antracit anthracite		03
.	.	.	<input type="checkbox"/> ES čierna matná zamatová elox silver		
.	.	.	<input type="checkbox"/> IW slonová kosť ivory white		

KRYT TLAČIDLA 1M

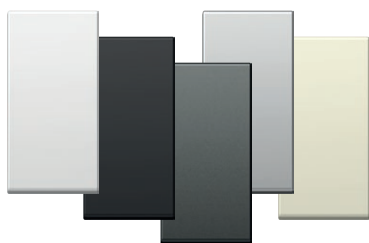

- TM11PW
- TM11SB
- TM11AT
- TM11ES
- TM11IW

- vymeniteľný kryt tlačidla 1M
- v súlade s normou EN 60669-1

BUTTON 1M

- replaceable button 1M
- in accordance with EN 60669-1



KRYT TLAČIDLA S INDIKÁTOROM 1M



- TM11PWIN
- TM11ATIN
- TM11SBIN
- TM11ESIN
- TM11IWIN

- vymeniteľný kryt tlačidla 1M
- v súlade s normou EN 60669-1

BUTTON 1M INDICATOR

- replaceable button 1M
- in accordance with EN 60669-1



KRYT TLAČIDLA 2M

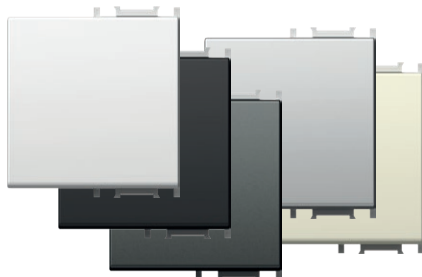

- TM12PW
- TM12SB
- TM12AT
- TM12ES
- TM12IW

- vymeniteľný kryt tlačidla 2M
- pri zmene vypínača alebo tlačidla z 1M na 2M veľkosť
- v súlade s normou EN 60669-1

BUTTON 2M

- replaceable button 2M with button carrier
- to upgrade switch or push button from size 1M to size 2M
- in accordance with EN 60669-1



KRYT TLAČIDLA S INDIKÁTOROM 2M

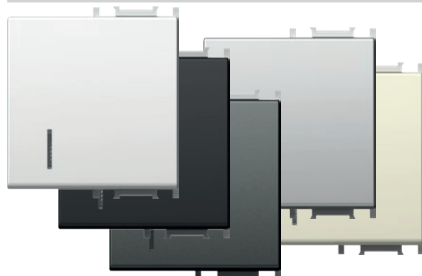

- TM12PWIN
- TM12SBIN
- TM12ATIN
- TM12ESIN
- TM12IWIN

- vymeniteľný kryt tlačidla 2M
- pri zmene vypínača alebo tlačidla z 1M na 2M veľkosť
- v súlade s normou EN 60669-1

BUTTON 2M INDICATOR

- replaceable button 2M with button carrier
- to upgrade switch or push button from size 1M to size 2M
- in accordance with EN 60669-1



KRYT NA SPÍNAČ S POPISNÝM ŠTÍTKOM

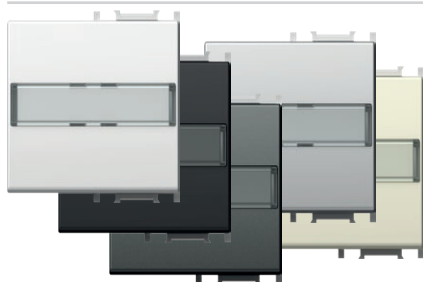

- TM13PWIL
- TM13SBIL
- TM13ATIL
- TM13ESIL
- TM13IWIL

- vymeniteľné tlačidlo 2M s úchytkou tlačidla
 - pri zmene vypínača alebo tlačidla z 1M na 2M veľkosť
 - v súlade s normou EN 60669-1

BUTTON 2M WITH INSCRIPTION PLATE
 - replaceable button 2M with button carrier
 - to upgrade switch or push button from size 1M to size 2M
 - in accordance with EN 60669-1



KRYT NA SPÍNAČ DVOJPÓLOVÝ

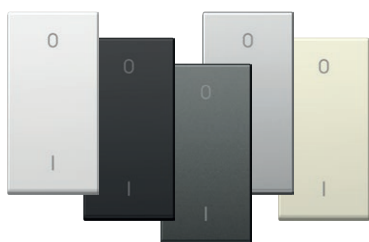

- TM15PW
- TM15SB
- TM15AT
- TM15ES
- TM15IW

- vymeniteľné tlačidlo 1M
 - len v kombinácii s mechanizmom SM20
 - v súlade s normou EN 60669-1

BUTTON 1M 2POLE
 - replaceable button 1M
 - only in combination with mechanism SM20
 - in accordance with EN 60669-1



VÝPLŇ 1M

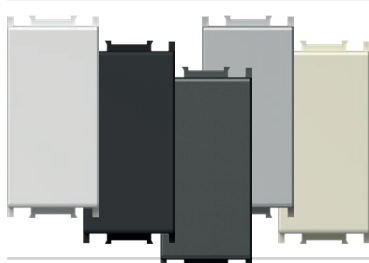

- TM21PW
- TM21SB
- TM21AT
- TM21ES
- TM21IW

- výplňový modul na zaplnenie prázdnych miest
 - v súlade s normou EN 60669-1

BLANK 1M
 - blank modul to fill up empty spaces
 - in accordance with EN 60669-1



VÝPLŇ 2M



- TM22PW
- TM22SB
- TM22AT
- TM22ES
- TM22IW

- výplňový modul na zaplnenie prázdnych miest
 - v súlade s normou EN 60669-1

BLANK 2M
 - blank modul to fill up empty spaces
 - in accordance with EN 60669-1



KÁBLOVÁ PRECHODKA 1M

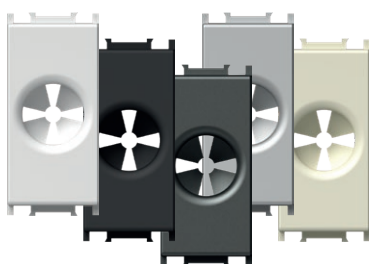

- TM31PW
- TM31SB
- TM31AT
- TM31ES
- TM31IW

- vývod na kábel
 - v súlade s normou EN-60669-1

CABLE OUTLET 1M
 - outlet for cable
 - in accordance with EN-60669-1



1M = 22,5 x 45
 2M = 45 x 45

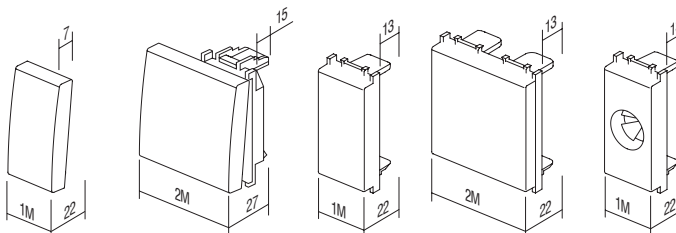

TM11
TM15

TM12
TM13

TM21

TM22

TM31

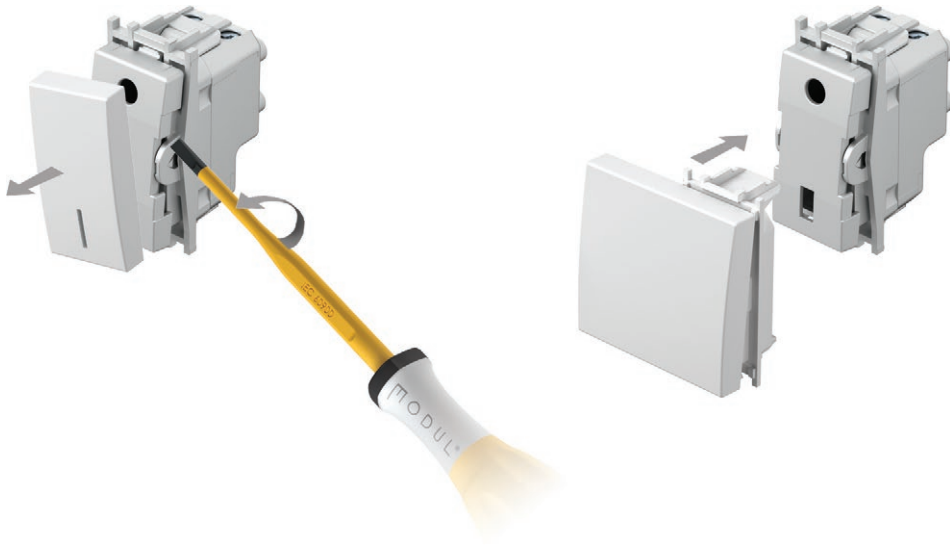

LASEROVÁ POTLAČ NA KRYTOCH TLAČIDIEL

- laserová tlač akejkoľvek grafiky na vyznačených miestach
- štandardné symboly z ponuky, ostatné na vyziadanie

LASER PRINT ON BUTTONS

- laser print of any graphics on marked locations
- standard symbols from stock, other on request

1M

A
B
C

2M

A	D	G
B	E	H
C	F	I

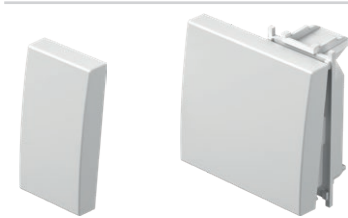

SYMBOLY

SYMBOLS

01	02	03	04	05	06	07	08	09	10	11	12	20	21	22	23
24	25	26	27	28	29	30	31	32	33	34	35	36	37	38	39
					OFF	ON					AC				
40	41	42	43	44	45	46	47	48							

ŠTANDARDNÉ SYMBOLY

STANDARD SYMBOLS

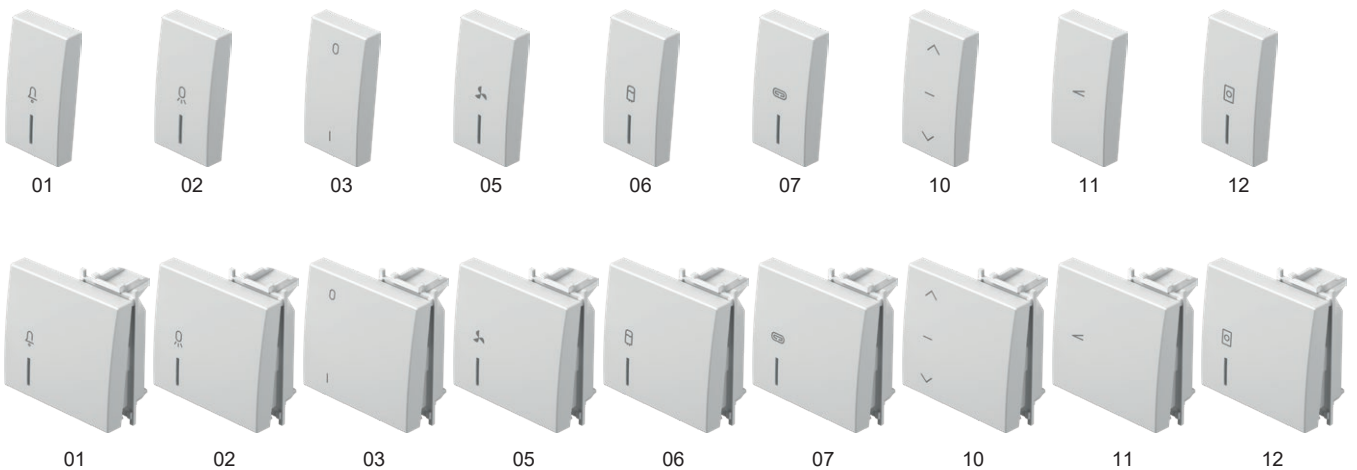

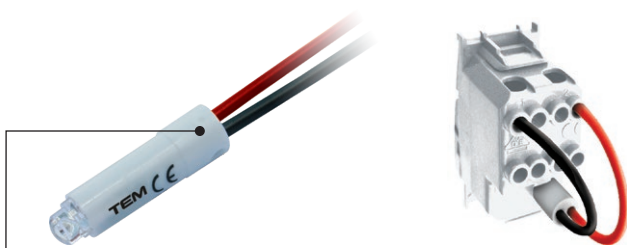

IA20

WH

typ type	popis description	technické dáta technical data	farba colour
IA10	TLEJIVKA NEON LAMP	230V~ 0,34W	<input type="checkbox"/> WH biela white
IA20	LED DIÓDA LED LAMP	230V~ AC/DC 0,40W	<input checked="" type="checkbox"/> BL modrá blue
IA21	LED DIÓDA LED LAMP	24V AC/DC 0,20W	<input checked="" type="checkbox"/> RD červená red
·	·	·	<input checked="" type="checkbox"/> GR zelená green
·	·	·	<input checked="" type="checkbox"/> OR oranžová orange

TLEJIVKA 230 V ~ 0,34 W

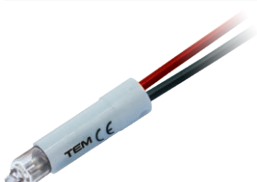

IA10OR

- na indikáciu, osvetlenie alebo stále osvetlenie spínača
- v kombinácii s krytom tlačidla s indikátorom

NEON LAMP 230V~ 0,34W

- for indication, illumination or constant illumination of switch
- in combination with button with indicator

LED DIÓDA 230 V AC/DC 0,40 W



- IA20WH
- IA20GR
- IA20RD
- IA20BL

- na indikáciu, osvetlenie alebo stále osvetlenie spínača
- v kombinácii s krytom tlačidla s indikátorom

LED LAMP 230V AC/DC 0,40W

- for indication, illumination or constant illumination of switch
- in combination with button with indicator

LED DIÓDA 24 V AC/DC 0,20 W



- IA21WH
- IA21RD

- na indikáciu, osvetlenie alebo stále osvetlenie spínača
- v kombinácii s krytom tlačidla s indikátorom

LED LAMP 24V AC/DC 0,20W

- for indication, illumination or constant illumination of switch
- in combination with button with indicator

LED DIÓDA 12 V AC/DC 0,10 W



- IA22WH
- IA22RD

- na indikáciu, osvetlenie alebo stále osvetlenie spínača
- v kombinácii s krytom tlačidla s indikátorom

LED LAMP 12V AC/DC 0,10W

- for indication, illumination or constant illumination of switch
- in combination with button with indicator

RC OBVOD 250V~



IA50

- RC obvod na odstránenie rušenia v prevádzke LED svietidiel
- sú možné paralelné zapojenia viacerých RC obvodov so svietidlami
- 0,1 µF, 100 Ω, 250V~

RC CIRCUIT 250V~

- RC circuit to eliminate disturbances in the operation of LED lamps
- parallel connections of more RC circuits with lamps are possible
- 0,1 µF, 100 Ω, 250V~

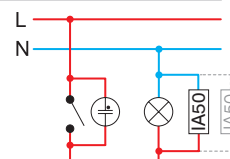

I L L U M I N A T I O N I A

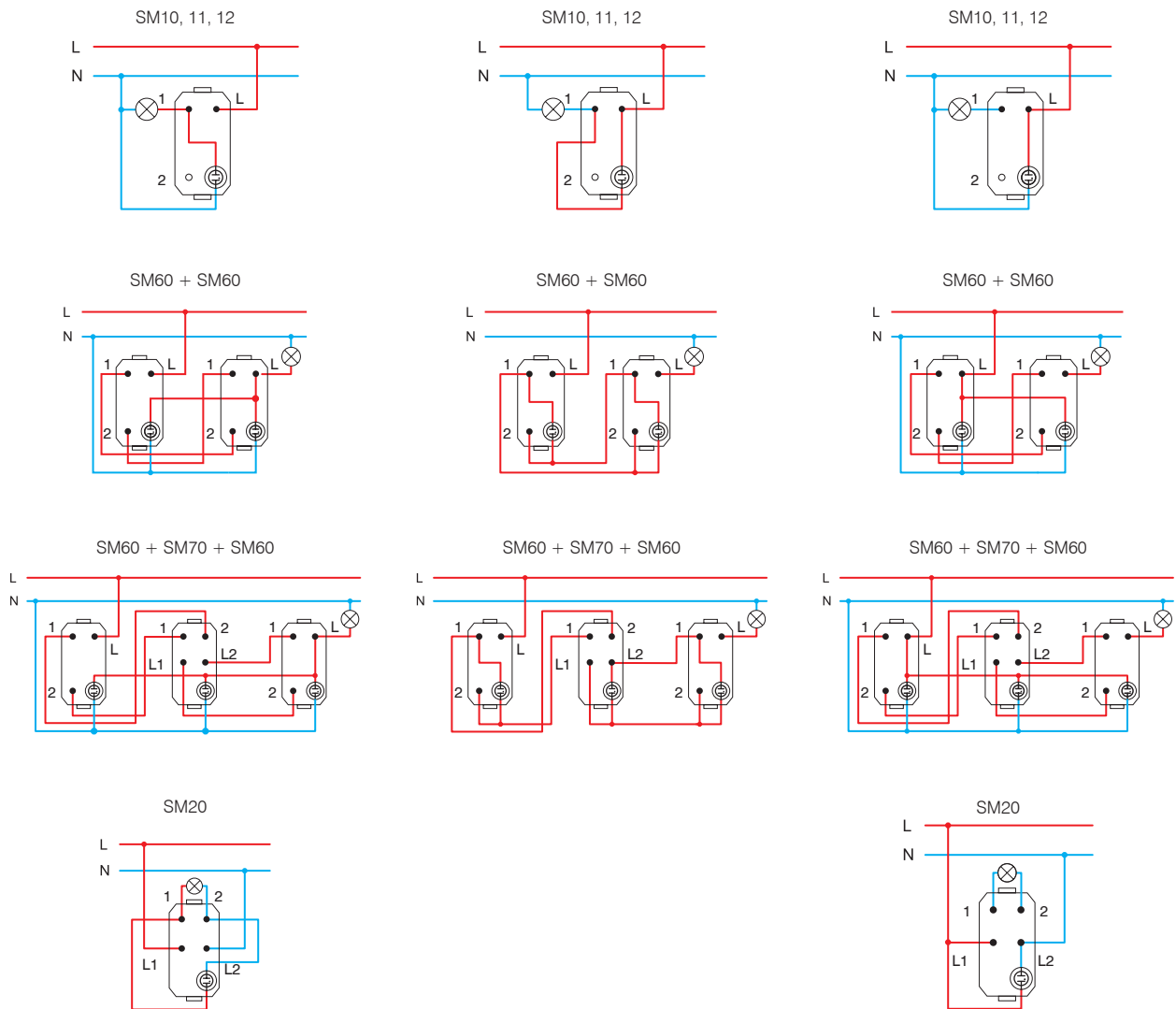
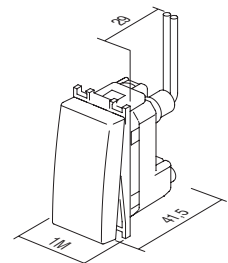
* Indikácia /
IndicationOsvetlenie /
IlluminationStále osvetlenie /
Constant illumination* schéma zapojenia pre úsporné žiarivky (CFL, LED) /
wiring scheme for energy saving lamps (CFL, LED)1M = 22,5 x 45
2M = 45 x 45

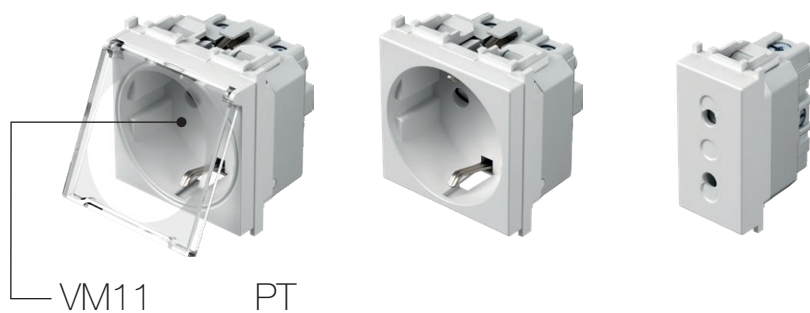

typ type	popis description	technické dáta technical data	veľkosť size	farba colour																																				
VM10	ZÁSUVKA SCHUKO + KS SOCKET SCHUKO+KS	2P+E 16A 250V~	2M	<table border="0"> <tr> <td> PW</td> <td>polárna biela polar white</td> <td> PT</td> <td>biela + transparentná white+transparent</td> <td> PP</td> <td>biela + biela white+white</td> </tr> </table>	PW	polárna biela polar white	PT	biela + transparentná white+transparent	PP	biela + biela white+white																														
PW	polárna biela polar white	PT	biela + transparentná white+transparent	PP	biela + biela white+white																																			
VM11	ZÁSUVKA SCHUKO + KS + KRYT SOCKET SCHUKO+KS+COVER	2P+E 16A 250V~	2M	<table border="0"> <tr> <td> SB</td> <td>čierna matná soft touch black</td> <td> BT</td> <td>čierna + transparentná soft touch black+transparent</td> <td> BB</td> <td>čierna matná + čierna matná soft touch black+black</td> </tr> </table>	SB	čierna matná soft touch black	BT	čierna + transparentná soft touch black+transparent	BB	čierna matná + čierna matná soft touch black+black																														
SB	čierna matná soft touch black	BT	čierna + transparentná soft touch black+transparent	BB	čierna matná + čierna matná soft touch black+black																																			
VM20	ZÁSUVKA EURO + KS SOCKET EURO+KS	2P 10A 250V~	1M	<table border="0"> <tr> <td> AT</td> <td>antracit anthracite</td> <td> AT</td> <td>antracit + transparentná anthracite+transparent</td> <td> AA</td> <td>antracit + antracit anthracite+anthracite</td> </tr> <tr> <td> ES</td> <td>strieborná elox silver</td> <td> ST</td> <td>strieborná + transparentná silver+transparent</td> <td> SS</td> <td>strieborná + strieborná silver+silver</td> </tr> <tr> <td> IW</td> <td>slonová kosť ivory white</td> <td> IT</td> <td>slonová kosť + transparentná ivory+transparent</td> <td> II</td> <td>slonová kosť + slonová kosť ivory+ivory</td> </tr> <tr> <td> RD</td> <td>červená red</td> <td> RT</td> <td>červená + transparentná red+transparent</td> <td> RR</td> <td>červená + červená red+red</td> </tr> <tr> <td> GR</td> <td>zelená green</td> <td> GT</td> <td>zelená + transparentná green+transparent</td> <td> GG</td> <td>zelená + zelená green+green</td> </tr> <tr> <td> OR</td> <td>oranžová orange</td> <td> OT</td> <td>oranžová + transparentná orange+transparent</td> <td> OO</td> <td>oranžová + oranžová orange+orange</td> </tr> </table>	AT	antracit anthracite	AT	antracit + transparentná anthracite+transparent	AA	antracit + antracit anthracite+anthracite	ES	strieborná elox silver	ST	strieborná + transparentná silver+transparent	SS	strieborná + strieborná silver+silver	IW	slonová kosť ivory white	IT	slonová kosť + transparentná ivory+transparent	II	slonová kosť + slonová kosť ivory+ivory	RD	červená red	RT	červená + transparentná red+transparent	RR	červená + červená red+red	GR	zelená green	GT	zelená + transparentná green+transparent	GG	zelená + zelená green+green	OR	oranžová orange	OT	oranžová + transparentná orange+transparent	OO	oranžová + oranžová orange+orange
AT	antracit anthracite	AT	antracit + transparentná anthracite+transparent	AA	antracit + antracit anthracite+anthracite																																			
ES	strieborná elox silver	ST	strieborná + transparentná silver+transparent	SS	strieborná + strieborná silver+silver																																			
IW	slonová kosť ivory white	IT	slonová kosť + transparentná ivory+transparent	II	slonová kosť + slonová kosť ivory+ivory																																			
RD	červená red	RT	červená + transparentná red+transparent	RR	červená + červená red+red																																			
GR	zelená green	GT	zelená + transparentná green+transparent	GG	zelená + zelená green+green																																			
OR	oranžová orange	OT	oranžová + transparentná orange+transparent	OO	oranžová + oranžová orange+orange																																			

ZÁSUVKA SCHUKO + KS 2P+E 16 A 25 0V ~ 2M

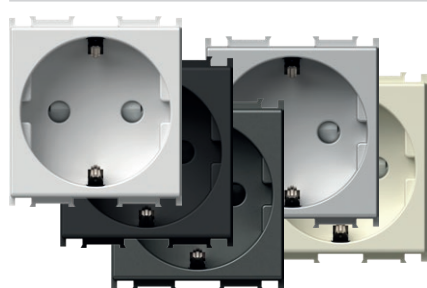

- VM10PW
- VM10SB
- VM10AT
- VM10ES
- VM10IW

- 2P+E schuko
- 16 A 250 V ~, typ VM10
- v súlade s normou IEC 60884-1, CEE7
- skrutkové upevnenie vodičov 1,5 – 2,5 mm²
- zabudovaná ochrana pred dotykom s kontaktmi pod napätím

SOCKET SCHUKO+KS 2P+E 16A 250V~ 2M

- 2P+E schuko
- 16A 250V~, type VM10
- in accordance with IEC 60884-1, CEE7
- screw contacts 1.5-2.5 mm²
- shuttered live contacts



ZÁSUVKA SCHUKO + KS 2P+E 16 A 25 0V ~ 2M

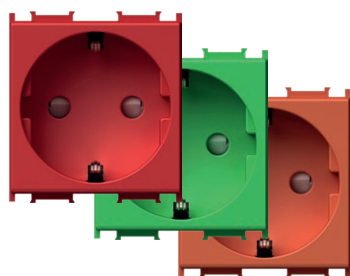

- VM10RD
- VM10GR
- VM10OR

- 2P+E schuko
- 16 A 250 V ~, typ VM10
- v súlade s normou IEC 60884-1, CEE7
- skrutkové upevnenie vodičov 1,5 – 2,5 mm²
- zabudovaná ochrana pred dotykom s kontaktmi pod napätím

SOCKET SCHUKO+KS 2P+E 16A 250V~ 2M

- 2P+E schuko
- 16A 250V~, type VM10
- in accordance with IEC 60884-1, CEE7
- screw contacts 1.5-2.5 mm²
- shuttered live contacts



ZÁSUVKA SCHUKO + KS + KRYT 2P+E 16 A 250 V ~ 2M

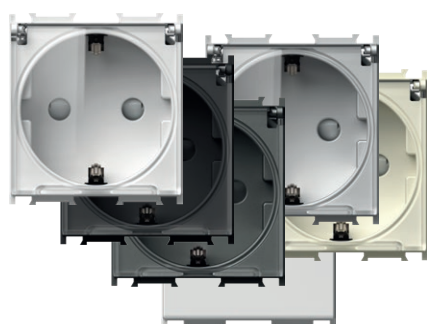

- VM11PT
- VM11BT
- VM11AT
- VM11ST
- VM11IT
- VM11PP

- 2P + E schuko + kryt
- 16 A 250 V ~, typ VM11
- v súlade s normou IEC 60884-1, CEE7
- skrutkové upevnenie vodičov 1,5 – 2,5 mm²
- zabudovaná ochrana pred dotykom s kontaktmi pod napätím

SOCKET SCHUKO+KS+COVER

- 2P+E 16A 250V~ 2M
- 2P+E schuko+cover
- 16A 250V~, type VM11
- in accordance with IEC 60884-1, CEE7
- screw contacts 1.5-2.5 mm²
- shuttered live contacts



S O C K E T S V M

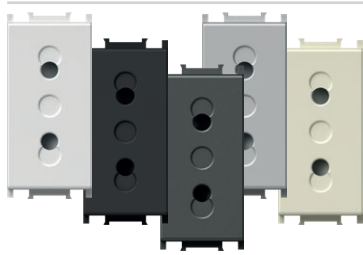

- VM20PW
- VM20SB
- VM20AT
- VM20ES
- VM20IW

ZÁSUVKA EURO + KS 2P 10 A 250 V ~ 1M

- 2P Euro
- 10 A 250 V ~, typ VM20
- v súlade s normou IEC 60884-1, CEE7
- skrutkové upevnenie vodičov 1,5 – 2,5 mm²
- zabudovaná ochrana pred dotykom s kontaktmi pod napätím



SOCKET EURO+KS 2P 10A 250V~ 1M

- 2P Euro
- 10A 250V~, type VM20
- in accordance with IEC 60884-1, CEE7
- screw contacts 1.5-2.5 mm²
- shuttered live contacts

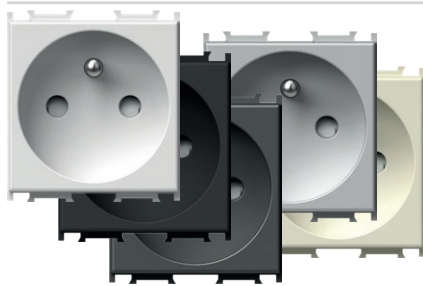

- VM40PW
- VM40SB
- VM40AT
- VM40ES
- VM40IW

FRANCÚZSKA ZÁSUVKA +KS 2P+E 16 A 250 V ~ 2M

- 2P+E francúzska
- 16 A 250 V ~, typ VM40
- v súlade s normou IEC 60884-1, NF C 61-314, CEE7
- skrutkové upevnenie vodičov 1,5 – 2,5 mm²
- zabudovaná ochrana pred dotykom s kontaktmi pod napätím



SOCKET FRENCH+KS 2P+E 16A 250V~ 2M

- 2P+E French
- 16A 250V~, type VM40
- in accordance with IEC 60884-1, NF C 61-314, CEE7
- screw contacts 1.5-2.5 mm²
- shuttered live contacts

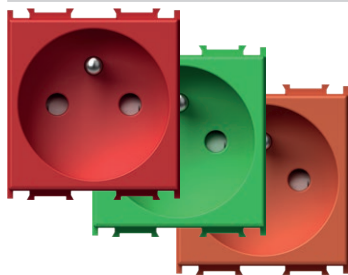

- VM40RD
- VM40GR
- VM40OR

FRANCÚZSKA ZÁSUVKA +KS 2P+E 16 A 250 V ~ 2M

- 2P+E francúzska
- 16 A 250 V ~, typ VM40
- v súlade s normou IEC 60884-1, NF C 61-314, CEE7
- skrutkové upevnenie vodičov 1,5 – 2,5 mm²
- zabudovaná ochrana pred dotykom s kontaktmi pod napätím



SOCKET FRENCH+KS 2P+E 16A 250V~ 2M

- 2P+E French
- 16A 250V~, type VM40
- in accordance with IEC 60884-1, NF C 61-314, CEE7
- screw contacts 1.5-2.5 mm²
- shuttered live contacts



- VM41PT
- VM41BT
- VM41AT
- VM41ST
- VM41IT

FRANCÚZSKA ZÁSUVKA + KS + KRYT 2P+E 16 A 250 V ~ 2M

- 2P+E francúzska + kryt
- 16 A 250 V ~, typ VM41
- v súlade s normou IEC 60884-1, NF C 61-314, CEE7
- skrutkové upevnenie vodičov 1,5 – 2,5 mm²
- zabudovaná ochrana pred dotykom s kontaktmi pod napätím



SOCKET FRENCH+KS+COVER

- 2P+E 16A 250V~ 2M
- 2P+E French+cover
- 16A 250V~, type VM41
- in accordance with IEC 60884-1, NF C 61-314, CEE7
- screw contacts 1.5-2.5 mm²
- shuttered live contacts

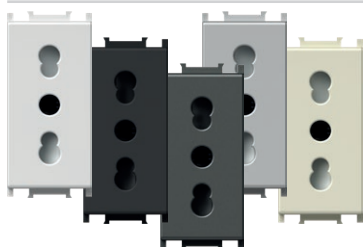

- VM30PW
- VM30SB
- VM30AT
- VM30ES
- VM30IW

TALIANSKA ZÁSUVKA P17/11 + KS 2P + E 16 A 250 V ~ 1M

- 2P + E talianska P17/11
- 16 A 250 V ~, typ VM30
- v súlade s normou IEC 60884-1, CEI 23-50
- skrutkové upevnenie vodičov 1,5 – 2,5 mm²
- zabudovaná ochrana pred dotykom s kontaktmi pod napätím



SOCKET ITALIAN P17/11+KS 2P+E 16A 250V~ 1M

- 2P+E Italian P17/11
- 16A 250V~, type VM30
- in accordance with IEC 60884-1, CEI 23-50
- screw contacts 1.5-2.5 mm²
- shuttered live contacts

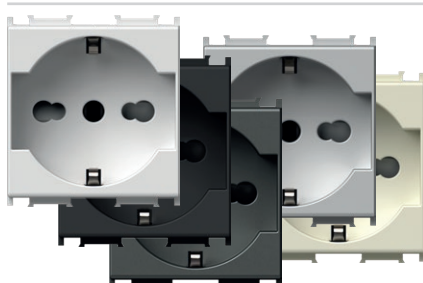

- VM31PW
- VM31SB
- VM31AT
- VM31ES
- VM31IW

ZÁSUVKA SCHUKO/ITA P17/11+KS 2P+E 16 A 250 V ~ 2M

- 2P+E schuko/italianska P17/11
- 16 A 250 V ~, typ VM31
- v súlade s normou IEC 60884-1, CEI 23-50
- skrutkové upevnenie vodičov 1,5 – 2,5 mm²
- zabudovaná ochrana pred dotykom s kontaktmi pod napätím

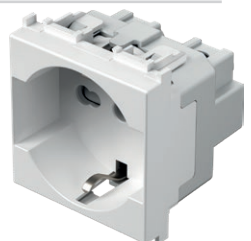

SOCKET SCHUKO/ITA P17/11+KS

- 2P+E 16A 250V~ 2M
- 2P+E schuko/Italian P17/11
- 16A 250V~, type VM31
- in accordance with IEC 60884-1, CEI 23-50
- screw contacts 1.5-2.5 mm²
- shuttered live contacts

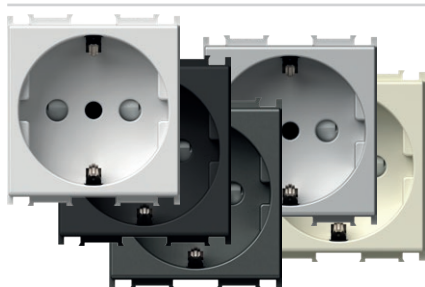

- VM32PW
- VM32SB
- VM32AT
- VM32ES
- VM32IW

ZÁSUVKA SCHUKO/ITA P30+KS 2P+E 16 A 250 V ~ 2M

- 2P+E schuko/italianska P30
- 16 A 250 V ~, typ VM32
- v súlade s normou IEC 60884-1, CEI 23-50
- skrutkové upevnenie vodičov 1,5 – 2,5 mm²
- zabudovaná ochrana pred dotykom s kontaktmi pod napätím



SOCKET SCHUKO/ITA P30+KS 2P+E 16A 250V~2M

- 2P+E schuko/Italian P30
- 16A 250V~, type VM32
- in accordance with IEC 60884-1, CEI 23-50
- screw contacts 1.5-2.5 mm²
- shuttered live contacts

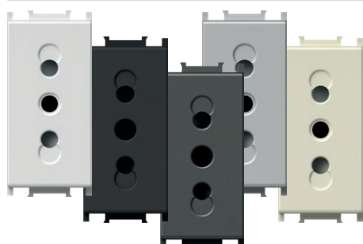

- VM33PW
- VM33SB
- VM33AT
- VM33ES
- VM33IW

TALIANSKA ZÁSUVKA P11+KS 2P+E 10 A 250 V ~ 1M

- 2P + E talianska P11
- 10 A 250 V ~, typ VM33
- v súlade s normou IEC 60884-1, CEI 23-50
- skrutkové upevnenie vodičov 1,5 – 2,5 mm²
- zabudovaná ochrana pred dotykom s kontaktmi pod napätím



SOCKET ITALIAN P11+KS 2P+E 10A 250V~1M

- 2P+E Italian P11
- 10A 250V~, type VM33
- in accordance with IEC 60884-1, CEI 23-50
- screw contacts 1.5-2.5 mm²
- shuttered live contacts

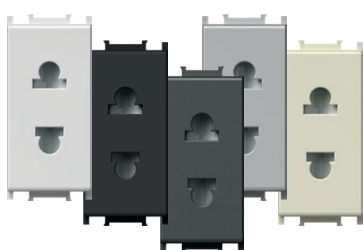

- VM21PW
- VM21SB
- VM21AT
- VM21ES
- VM21IW

EURÓPSKA/AMERICKÁ ZÁSUVKA + KS 2P 16 A 250 V ~ 1M

- 2P európska/americká
- 16 A 250 V ~, typ VM21
- skrutkové upevnenie vodičov 1,5 – 2,5 mm²
- zabudovaná ochrana pred dotykom s kontaktmi pod napätím
- len pre krajiny, ktoré nie sú členmi EÚ



SOCKET EURO/AMERICAN+KS 2P 16A 250V~1M

- 2P Euro/American
- 16A 250V~, type VM21
- screw contacts 1.5-2.5 mm²
- shuttered live contacts
- only for countries not members of EU

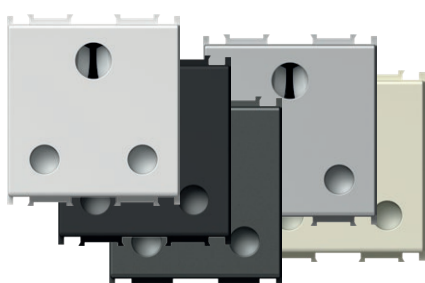

- VM51PW
- VM51SB
- VM51AT
- VM51ES
- VM51IW

BRITSKÁ ZÁSUVKA BS 546 + KS 2P + E 15 A 250 V ~ 2M

- 2P+E britská BS 546
- 15 A 250 V ~, typ VM51
- v súlade s normou BS 546
- skrutkové upevnenie vodičov 1,5 až 4 mm²
- zabudovaná ochrana pred dotykom s kontaktmi pod napätím



SOCKET BRITISH BS 546+KS 2P+E 15A 250V~2M

- 2P+E British BS 546
- 15A 250V~, type VM51
- in accordance with BS 546
- screw contacts 1.5-4 mm²
- shuttered live contacts

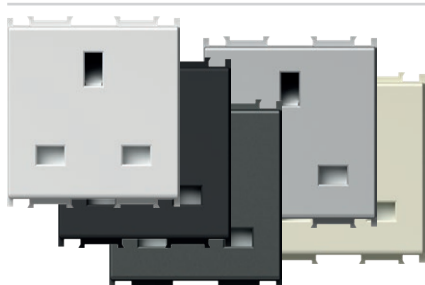

- VM52PW
- VM52SB
- VM52AT
- VM52ES
- VM52IW

BRITSKÁ ZÁSUVKA BS 1363-2+KS 2P+E 13 A 250 V ~ 2M

- 2P+E britská BS 1363-2
- 13 A 250 V ~, typ VM52
- v súlade s normou BS 1363-2
- skrutkové upevnenie vodičov 1,5 až 4 mm²
- zabudovaná ochrana pred dotykom s kontaktmi pod napätím

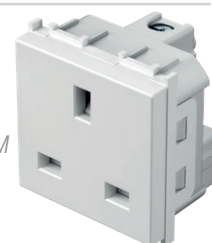

SOCKET BRITISH BS 1363-2+KS 2P+E 13A 250V~2M

- 2P+E British BS 1363-2
- 13A 250V~, type VM52
- in accordance with BS 1363-2
- screw contacts 1.5-4 mm²
- shuttered live contacts



VM80

- paralelné spojenie s prvou zásuvkou v rade
- trieda ochrany III
- U_c = 275 Vac, U_{oc}/I_{sc} = 6 kV/3 kA, U_p < 800 V
- v súlade s normou IEC 61643-1
- vodiče 1,5mm², IP20
- zvukový signál pri poruche



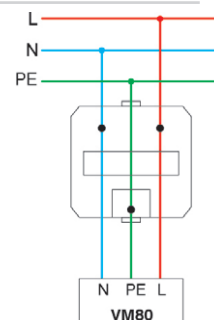

SURGE PROTECTOR MPE MINI 275V/50Hz

- parallel connection with the first socket in the row
- protection class III
- U_c=275Vac, U_{oc}/I_{sc}=6kV/3kA, U_p<800V
- in accordance with IEC 61643-1
- wires 1.5mm², IP20
- sound signal at breakdown





S O C K E T S V M

ZHODA ZÁSUVIEK A VIDLÍČ
SOCKETS AND PLUGS MATCHING

ZÁSUVKA / SOCKET	VM10 VM11	VM20	VM30	VM33	VM31	VM32	VM40 VM41	VM21
TVAR VIDLICE / PLUG STYLE								
Nemecký / German 	•				•	•		
Francúzsky / French 	•				•	•	•	
Taliansky / Italian S11 			•	•	•	•		
Taliansky / Italian S17 			•	•	•			
Európsky 	•	•	•		•	•	•	•

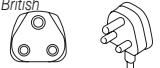
ZHODA ZÁSUVIEK A VIDLÍČ
SOCKETS AND PLUGS MATCHING

ZÁSUVKA / SOCKET	VM21	VM51	VM52
TVAR VIDLICE / PLUG STYLE			
Americký / American 	•		
Britský / British BS 546 		•	
Britský / British BS 1363-2 			•

1M = 22,5 x 45
2M = 45 x 45

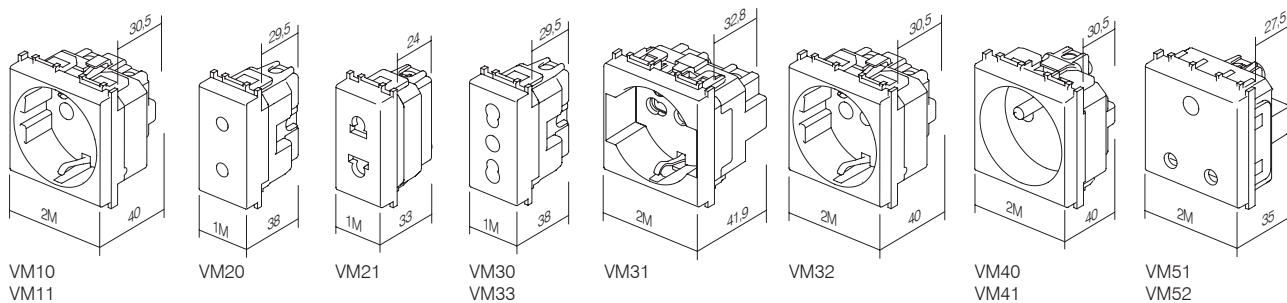



typ type	popis description	technické dáta technical data	veľkosť size	farba colour
KM10	ZÁSUVKA TV ZÁKLADNÁ SOCKET TV BASIC	0dB	1M	<input type="checkbox"/> PW polárna biela polar white
KM11	ZÁSUVKA TV KONCOVÁ SOCKET TV END-LINE	1dB	1M	<input checked="" type="checkbox"/> SB čierna matná zamatová soft touch black
KM12	ZÁSUVKA TV PRIEBEŽNÁ SOCKET TV TROUGHPASS	10dB	1M	<input checked="" type="checkbox"/> AT antracit anthracite
⋮	⋮	⋮	⋮	<input type="checkbox"/> ES strieborná matná elox silver
⋮	⋮	⋮	⋮	<input type="checkbox"/> IW slonová kosť ivory white

ZÁSUVKA TV ZÁKLADNÁ 0 dB 1M

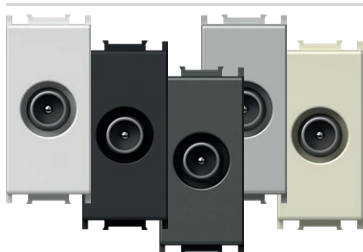

- KM10PW
- KM10SB
- KM10AT
- KM10ES
- KM10IW

- TV základná
- útlm 0 dB
- zadný konektor – F štandard
SOCKET TV BASIC 0dB 1M
- TV basic
- reduction 0dB
- back connector – F standard



ZÁSUVKA TV ZÁKLADNÁ 0 dB 2M

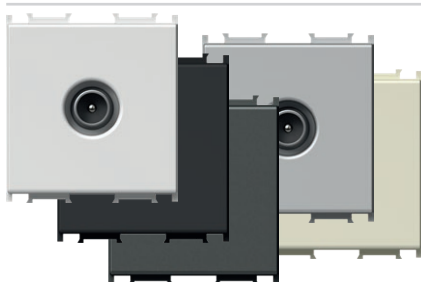

- KM20PW
- KM20SB
- KM20AT
- KM20ES
- KM20IW

- TV základná
- útlm 0 dB
- zadný konektor – F štandard
SOCKET TV BASIC 0dB 2M
- TV basic
- reduction 0dB
- back connector – F standard



ZÁSUVKA TV KONCOVÁ 1 dB 1M



- KM11PW
- KM11SB
- KM11AT
- KM11ES
- KM11IW

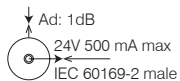

- TV koncová
- frekvenčné pásmo 5 ÷ 2400 MHz
- útlm < 1 dB
- v súlade s normou EN 50083-1
- skrutkové upevnenie vodičov
SOCKET TV END-LINE 1dB 1M
- TV end-line
- frequency range 5÷2400 MHz
- reduction < 1 dB
- in accordance with EN 50083-1
- screw contacts



ZÁSUVKA TV PRIEBEŽNÁ 10 dB 1M

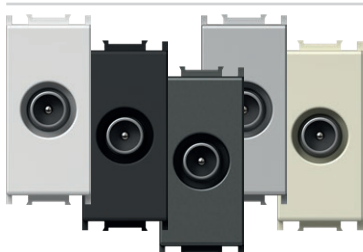

- KM12PW
- KM12SB
- KM12AT
- KM12ES
- KM12IW

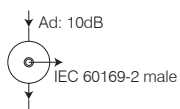

- TV priebežná
- frekvenčné pásmo 5 ÷ 2400 MHz
- útlm < 10 dB
- v súlade s normou EN 50083-1
- skrutkové upevnenie vodičov
SOCKET TV TROUGHPASS 10dB 1M
- TV troughpass
- frequency range 5÷2400 MHz
- reduction < 10 dB
- in accordance with EN 50083-1
- screw contacts



ZÁSUVKA SAT ZÁKLADNÁ 0 dB 1M



- KM15PW
- KM15SB
- KM15AT
- KM15ES
- KM15IW

- SAT základná
- útlm 0 dB
- zadný konektor – F štandard

SOCKET SAT BASIC 0dB 1M

- SAT basic
- reduction 0dB
- back connector – F standard



ZÁSUVKA SAT ZÁKLADNÁ 0 dB 2M

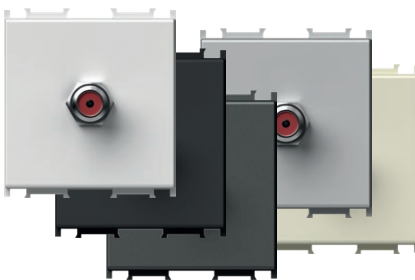

- KM24PW
- KM24SB
- KM24AT
- KM24ES
- KM24IW

- SAT základná
- útlm 0 dB
- zadný konektor – F štandard

SOCKET SAT BASIC 0dB 2M

- SAT basic
- reduction 0dB
- back connector – F standard



ZÁSUVKA SAT KONCOVÁ 1dB 1M



- KM16PW
- KM16SB
- KM16AT
- KM16ES
- KM16IW

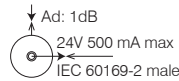

- SAT koncová
- frekvenčné pásmo 5 ÷ 2 400 MHz
- útlm < 1 dB
- v súlade s normou EN 50083-1
- skrutkové upevnenie vodičov

SOCKET SAT END-LINE 1dB 1M

- SAT end-line
- frequency range 5÷2400 MHz
- reduction < 1dB
- in accordance with EN 50083-1
- screw contacts



ZÁSUVKA R ZÁKLADNÁ 0 dB 1M



- KM19PW
- KM19SB
- KM19AT
- KM19ES
- KM19IW

- R základná
- útlm 0 dB
- zadný konektor – F štandard

SOCKET R BASIC 0dB 1M

- R basic
- reduction 0dB
- back connector – F standard



ZÁSUVKA R ZÁKLADNÁ 0 dB 2M

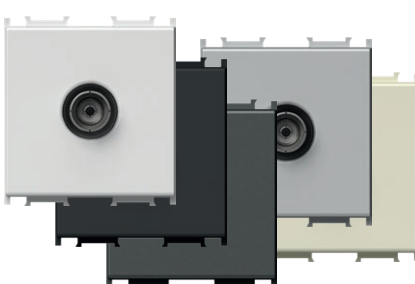

- KM29PW
- KM29SB
- KM29AT
- KM29ES
- KM29IW

- R základná
- útlm 0 dB
- zadný konektor – F štandard

SOCKET R BASIC 0dB 2M

- R basic
- reduction 0dB
- back connector – F standard



ZÁSUVKA SAT-TV KONCOVÁ 1 dB 2M

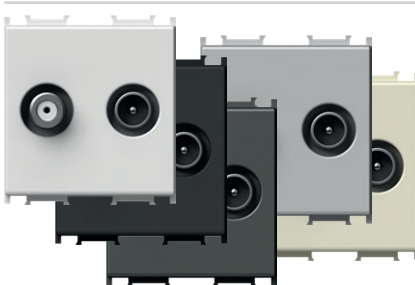

- KM25PW
- KM25SB
- KM25AT
- KM25ES
- KM25IW

- SAT-TV koncová
- frekvenčné pásmo 5 ÷ 2 400 MHz
- útlm < 1 dB
- v súlade s normou EN 50083-1
- skrutkové upevnenie vodičov

SOCKET SAT-TV END-LINE 1dB 2M

- SAT-TV end-line
- frequency range 5÷2400 MHz
- reduction < 1dB
- in accordance with EN 50083-1
- screw contacts

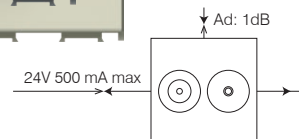

ZÁKLADNÉ SCHÉMY ZAPOJENIA
BASIC CONNECTION SAMPLES

Samostatné zapojenie
stand alone connection

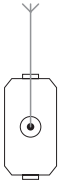

KM10
KM20
KM11
KM15
KM24
KM16
KM19
KM29
KM25

Zapojenie do hviezdy
star connection

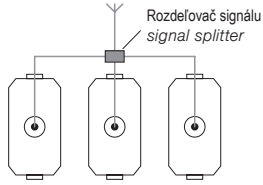

KM10
KM20
KM11
KM15
KM24
KM16
KM19
KM29
KM25

Sériové zapojenie
throughpass connection

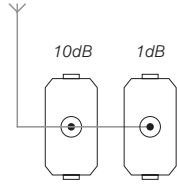

KM12 KM11



- KM22PW
- KM22SB
- KM22AT
- KM22ES
- KM22IW

ZÁSUVKA AUDIO 2 x RCA 1M

- audio 2 x RCA
- upevnenie vodičov vzadu spájkovaním

SOCKET AUDIO 2xRCA 1M

- audio 2x RCA
- soldering connection of cable at the back side



- KM23PW
- KM23SB
- KM23AT
- KM23ES
- KM23IW

ZÁSUVKA AUDIO REPRODUKTOROVÁ 1M

- audio 2 x Ø 4 mm
- na pripojenie reproduktorového vodiča, banánovej zástrčky Ø 4 mm alebo vidlicovej káblovej pätky
- upevnenie vodičov vzadu spájkovaním

SOCKET AUDIO LOUDSPEAKERS 1M

- audio 2x Ø4mm
- to accommodate speaker wire, banana plug Ø4mm or spades
- soldering connection of cable at the back side



- KM26PW
- KM26SB
- KM26AT
- KM26ES
- KM26IW

ZÁSUVKA AUDIO REPRODUKTOROVÁ 2M

- audio 2 x Ø 4 mm
- na pripojenie reproduktorového vodiča, banánovej zástrčky Ø 4 mm alebo vidlicovej káblovej pätky
- upevnenie vodičov vzadu spájkovaním

SOCKET AUDIO LOUDSPEAKERS 2M

- audio 2x Ø4mm
- to accommodate speaker wire, banana plug Ø4mm or spades
- soldering connection of cable at the back side



1M = 22,5 x 45
2M = 45 x 45

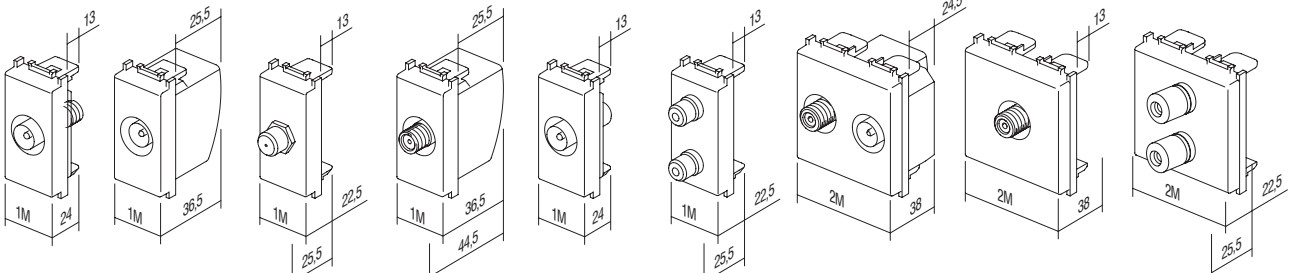

KM10

KM11
KM12

KM15

KM16

KM19

KM22
KM23

KM25

KM20
KM24
KM29

KM26

ZÁSUVKA TEL LT RJ11 6/4 1M



- KM30PW
- KM30SB
- KM30AT
- KM30ES
- KM30IW

- skrutka TEL LT
- RJ11 6/4
- v súlade s normou IEC 60603-7
- skrutkové upevnenie vodičov

SOCKET TEL LT RJ11 6/4 1M

- TEL LT screw
- RJ11 6/4
- in accordance with IEC 60603-7
- screw contacts

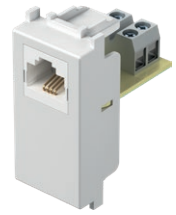

ZÁSUVKA TEL BT SEC 6/6 1M

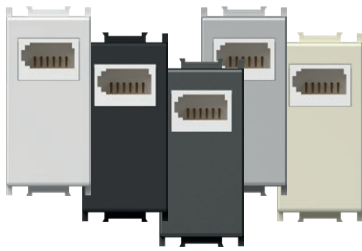

- KM31PW
- KM31SB
- KM31AT
- KM31ES
- KM31IW

- TEL BT štandardná britská
- SEC sekundárny 6/6
- v súlade s normou BS 6312
- skrutkové upevnenie vodičov

SOCKET TEL BT SEC 6/6 1M

- TEL BT British standard
- SEC secondary 6/6
- in accordance with BS 6312
- screw contacts



ZÁSUVKA TEL KS RJ11 6/4 1M

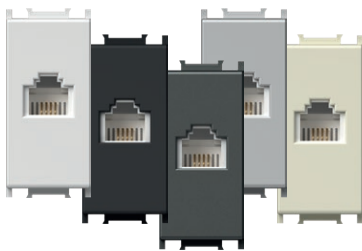

- KM36PW
- KM36SB
- KM36AT
- KM36ES
- KM36IW

- KS keystone štandard upevnenia
- RJ11 6/4
- v súlade s normou IEC 60603-7

SOCKET TEL KS RJ11 6/4 1M

- KS keystone fixing standard
- RJ11 6/4
- in accordance with IEC 60603-7

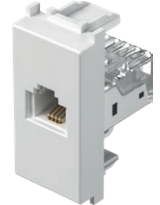

ZÁSUVKA KAT. 5e KS RJ45 8/8 1M

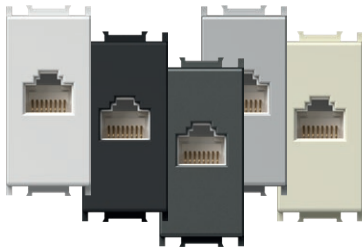

- KM37PW
- KM37SB
- KM37AT
- KM37ES
- KM37IW

- KS keystone štandard upevnenia
- KAT. 5e, RJ45 8/8
- v súlade s normou IEC 60603-7

SOCKET CAT5e KS RJ45 8/8 1M

- KS keystone fixing standard
- CAT5e, RJ45 8/8
- in accordance with IEC 60603-7

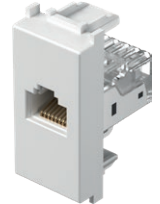

ADAPTÉR KS 1M

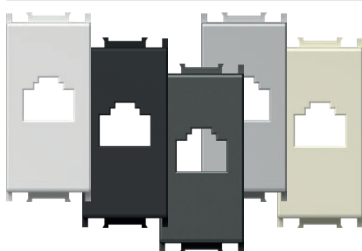

- KM35PW
- KM35SB
- KM35AT
- KM35ES
- KM35IW

- KS keystone štandard upevnenia
- AMP, Avaya, Brandrex, FMT, Mfico, Tyco, ...
- komunikačný modul nie je súčasťou

ADAPTER KS 1M

- KS keystone fixing standard
- AMP, Avaya, Brandrex, FMT, Mfico, Tyco, ...
- communication module not included



ADAPTÉR KS S OCHRANOU PROTI PRACHU 1M

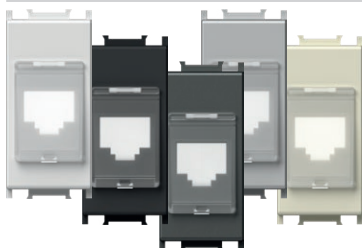

- KM38PW
- KM38SB
- KM38AT
- KM38ES
- KM38IW

- KS keystone štandard upevnenia s ochranou proti prachu
- AMP, Avaya, Brandrex, FMT, Mfico, Tyco, ...
- komunikačný modul nie je súčasťou

ADAPTER KS WITH DUST PROTECTION 1M

- KS keystone fixing standard with dust protection
- AMP, Avaya, Brandrex, FMT, Mfico, Tyco, ...
- communication module not included



ZÁSUVKA KS KAT. 6 SCH RJ45 8/8 1M

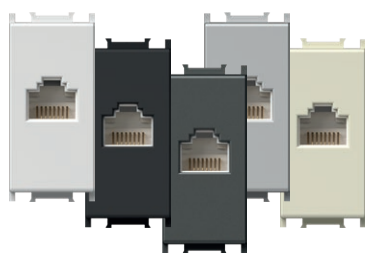

- KM39PW
- KM39SB
- KM39AT
- KM39ES
- KM39IW

- KS keystone štandard upevnenia
 - KAT. 6 UTP bez použitia nástrojov, RJ45 8/8
 - v súlade s normou ISO/IEC 11801

SOCKET CAT6 SCH KS RJ45 8/8 1M

- KS keystone fixing standard
 - CAT6 UTP toolless, RJ45 8/8
 - in accordance with ISO/IEC 11801



ADAPTÉR KS UNIVERZÁLNY 1M

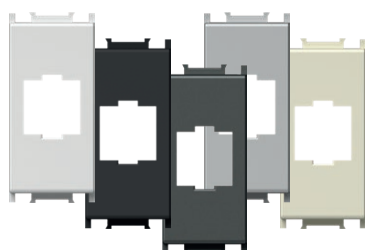

- KM50PW
- KM50SB
- KM50AT
- KM50ES
- KM50IW

- KS keystone štandard upevnenia
 - vhodné pre HDMI, USB
 - komunikačný modul nie je súčasťou

ADAPTER KS UNIVERSAL 1M

- KS keystone fixing standard
 - suitable for HDMI, USB
 - communication module not included



ADAPTÉR PD 1M

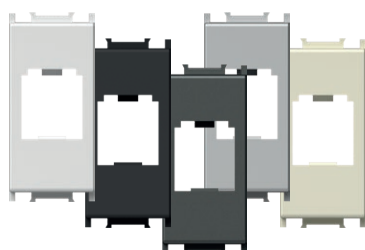

- KM40PW
- KM40SB
- KM40AT
- KM40ES
- KM40IW

- štandard upevnenia PD Panduit Mini-COM
 - komunikačný modul nie je súčasťou

ADAPTER PD 1M

- PD Panduit Mini-COM fixing standard
 - communication module not included



ADAPTÉR PD S OCHRANOU PROTI PRACHU 1M



- KM43PW
- KM43SB
- KM43AT
- KM43ES
- KM43IW

- PD štandard upevnenia Panduit Mini-COM
 s ochranou proti prachu
 - komunikačný modul nie je súčasťou

ADAPTER PD WITH DUST PROTECTION 1M

- PD Panduit Mini-COM fixing standard with
 dust protection
 - communication module not included



ADAPTÉR R&M 1M

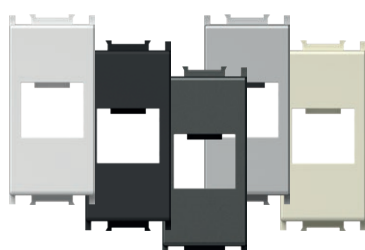

- KM46PW
- KM46SB
- KM46AT
- KM46ES
- KM46IW

- štandard upevnenia R&M
 - komunikačný modul nie je súčasťou

ADAPTER R&M 1M

- R&M fixing standard
 - communication module not included



ADAPTÉR CAT6A 1M ZNAČKY R&M

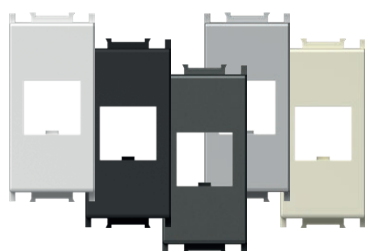

- KM52PW
- KM52SB
- KM52AT
- KM52ES
- KM52IW

- R&M upevnenie pre CAT6A
 - komunikačný modul nie je súčasťou

ADAPTER R&M CAT6A 1M

- R&M fixing for CAT6A
 - communication module not included





- KM47PW
- KM47SB
- KM47AT
- KM47ES
- KM47IW

ADAPTÉR R&M S OCHRANOU PROTI PRACHU 1M

- R&M štandard upevnenia s ochranou proti prachu
- komunikačný modul nie je súčasťou

ADAPTER R&M WITH DUST PROTECTION 1M

- R&M fixing standard with dust protection
- communication module not included



- KM53PW
- KM53SB
- KM53AT
- KM53ES
- KM53IW

ADAPTÉR R&M CAT6A S OCHRANOU PROTI PRACHU 1M

- R&M upevnenie pre CAT6A s ochranou proti prachu
- komunikačný modul nie je súčasťou

ADAPTER R&M CAT6A WITH DUST PROTECTION 1M

- R&M fixing for CAT6A with dust protection
- communication module not included



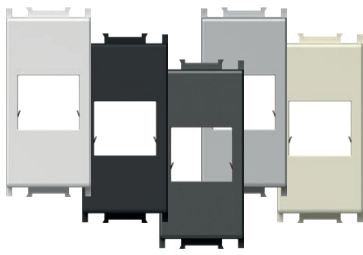

- KM45PW
- KM45SB
- KM45AT
- KM45ES
- KM45IW

ADAPTÉR LK 1M

- štandard upevnenia LK LeoniKerpen eLine/BKS NewLine
- komunikačný modul nie je súčasťou

ADAPTER LK 1M

- LK LeoniKerpen eLine / BKS NewLine fixing standard
- communication module not included

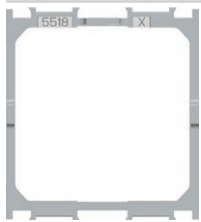
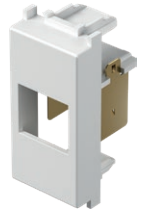

KA26

ADAPTÉR NEXANS/SCHRACK 2M

- adaptér upevnenia pre modul Nexans LANmark a Schrack 45 x 45 mm
- vhodné pre Nexans typu N423.540N
- vhodné pre Schrack typu HSEMD02W2F
- komunikačný modul nie je súčasťou

ADAPTER NEXANS/SCHRACK 2M

- fixing adapter for Nexans LANmark and Schrack module 45x45mm
- suitable for Nexans type N423.540N
- suitable for Schrack type HSEMD02W2F
- communication module not included

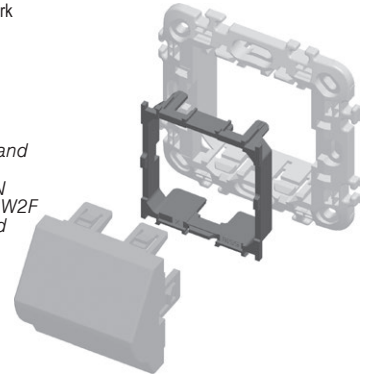

- KM48PW
- KM48SB
- KM48AT
- KM48ES
- KM48IW

ADAPTÉR AT&T SYSTIMAX S OCHRANOU PROTI PRACHU 1M

- štandard upevnenia AT&T Systimax s ochranou proti prachu
- komunikačný modul nie je súčasťou

ADAPTER AT&T SYSTIMAX WITH DUST PROTECTION 1M

- AT&T Systimax fixing standard with dust protection
- communication module not included



- KM51PW
- KM51SB
- KM51AT
- KM51ES
- KM51IW

USB ZÁSUVKA TYPU 1M

- USB 2.0 zásuvka typu A
- skrutkové upevnenie vodičov, raster 5 mm, 1,5 mm², 1 x 2P + 1 x 3P
- zapojenie:
 - PIN 1 – VCC (+5 V, červený vodič)
 - PIN 2 – dátový - (biely vodič)
 - PIN 3 – dátový + (zelený vodič)
 - PIN 4 – GND – uzemňovací (čierny vodič)
 - S – tienenie
- v súlade so Smernicou 2011/95/EC (RoHS2)

SOCKET USB TYPE A 1M

- USB 2.0 socket type A
- screw contacts, raster 5 mm, 1,5 mm², 1x2P + 1x3P
- wiring:
 - PIN 1 – VCC (+5V, red wire)
 - PIN 2 – Data - (white wire)
 - PIN 3 – Data + (green wire)
 - PIN 4 – GND - ground (black wire)
 - S – shield
- in accordance with directive 2011/95/EU (RoHS2)



1M = 22,5 x 45
2M = 45 x 45

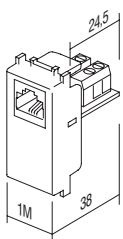

KM30

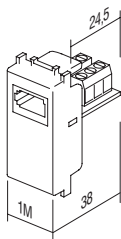

KM31

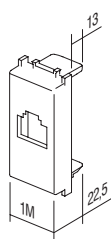

KM35
KM38
KM48

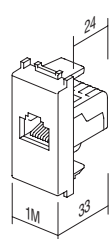

KM36
KM37
KM39

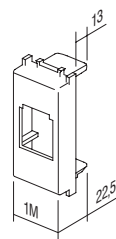

KM40
KM43

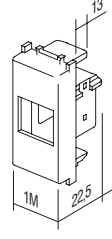

KM45

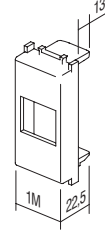

KM46
KM47
KM50
KM52
KM53

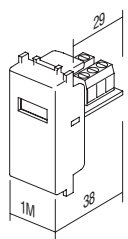

KM51



KA10

typ type	popis description	technické dáta technical data
KA10	KONEKTOR KS KAT. 3 CONNECTOR KS CAT3	RJ11 6/4
KA11	KONEKTOR KS KAT. 5e CONNECTOR KS CAT5e	RJ45 8/8
KA12	KONEKTOR KS KAT. 5eS CONNECTOR KS CAT5eS	RJ45 8/8
⋮	⋮	⋮



KONEKTOR KS KAT. 3 RJ11 6/4

- KA10
- KS keystone štandard upevnenia
 - KAT. 3, RJ11 6/4
 - v súlade s normou IEC 60603-7
- CONNECTOR KS CAT3 RJ11 6/4*
- KS keystone fixing standard
 - CAT3, RJ11 6/4
 - in accordance with IEC 60603-7



KONEKTOR KS KAT. 5e RJ45 8/8

- KA11
- KS keystone štandard upevnenia
 - KAT. 5e, RJ45 8/8
 - v súlade s normou IEC 60603-7
- CONNECTOR KS CAT5e RJ45 8/8*
- KS keystone fixing standard
 - CAT5e, RJ45 8/8
 - in accordance with IEC 60603-7



KONEKTOR KS KAT. 5eS RJ45 8/8

- KA12
- KS keystone štandard upevnenia
 - KAT. 5eS, RJ45 8/8
 - v súlade s normou IEC 60603-7
- CONNECTOR KS CAT5eS RJ45 8/8*
- KS keystone fixing standard
 - CAT5eS, RJ45 8/8
 - in accordance with IEC 60603-7



KONEKTOR KS KAT. 6 SCH RJ45 8/8

- KA15
- KS keystone štandard upevnenia
 - KAT. 6 UTP bez použitia nástrojov, RJ45 8/8
 - v súlade s normou ISO/IEC 11801
- CONNECTOR KS CAT6 SCH RJ45 8/8*
- KS keystone fixing standard
 - CAT6 UTP toolless, RJ45 8/8
 - in accordance with ISO/IEC 11801



KONEKTOR KS KAT. 6S SCH RJ45 8/8

- KA16
- KS keystone štandard upevnenia
 - KAT. 6S STP bez použitia nástrojov, RJ45 8/8
 - v súlade s normou ISO/IEC 11801
- CONNECTOR KS CAT6S SCH RJ45 8/8*
- KS keystone fixing standard
 - CAT6S STP toolless, RJ45 8/8
 - in accordance with ISO/IEC 11801



KONEKTOR KS KAT. 6a SCH RJ45 8/8

- KA17
- KS keystone štandard upevnenia
 - KAT. 6a STP bez použitia nástrojov, RJ45 8/8
 - v súlade s normou ISO/IEC 11801
- CONNECTOR KS CAT6a SCH RJ45 8/8*
- KS keystone fixing standard
 - CAT6a STP toolless, RJ45 8/8
 - in accordance with ISO/IEC 11801



KA18

KONEKTOR SLIM KS KAT. 6S SCH RJ45 8/8

- KS keystone štandard upevnenia
- úzke prevedenie
- KAT. 6S STP bez použitia nástrojov, RJ45 8/8
- v súlade s normou ISO/IEC 11801
- vhodný aj pre dvojité adaptéry KE46

CONNECTOR SLIM KS CAT6S SCH RJ45 8/8

- KS keystone fixing standard
- slim style
- CAT6S STP toolless, RJ45 8/8
- in accordance with ISO/IEC 11801
- suitable also for KE46 double adapter



KA27

KONEKTOR KS HDMI

- KS keystone štandard upevnenia
- len v kombinácii s adaptérom KM50
- HDMI/HDMI

CONNECTOR KS HDMI

- KS keystone fixing standard
- only in combination with adapter KM50
- HDMI/HDMI



KA28

KÁBEL KS HDMI

- KS keystone štandard upevnenia
- len v kombinácii s adaptérom KM50
- HDMI/HDMI

CABLE KS HDMI

- KS keystone fixing standard
- only in combination with adapter KM50
- HDMI/HDMI



typ type	popis description	technické dáta technical data	veľkosť size	farba colour
EM10	STMIEVAČ ROTAČNÝ DIMMER ROTATIVE	R 300W	1M	<input type="checkbox"/> PW polárna biela polar white
EM12	STMIEVAČ ROTAČNÝ STRIEDAVÝ DIMMER ROTATIVE 2WAY	RL 300W	1M	<input checked="" type="checkbox"/> SB čierna matná zamatová soft touch black
EM23	STMIEVAČ ZABUDOVATELNÝ DIMMER INBOX	RC,RL 200VA	/	<input checked="" type="checkbox"/> AT antracit anthracite
·	·	·	·	<input type="checkbox"/> ES strieborná matná elox silver
·	·	·	·	<input type="checkbox"/> IW slonová kosť ivory white
·	·	·	·	<input type="checkbox"/> BL modrá blue
·	·	·	·	<input type="checkbox"/> RD červená red
·	·	·	·	<input type="checkbox"/> GR zelená green
·	·	·	·	<input type="checkbox"/> OR oranžová orange
·	·	·	·	<input type="checkbox"/> RG červeno-zelená red/green

STMIEVAČ ROTAČNÝ R 300 W 1M



- EM10PW
- EM10SB
- EM10AT
- EM10ES
- EM10IW

- ovládanie rotácie bez prepínača
- typ RTS34.43 RVP, zaťaženie R, 40 W – 300 W
- napájacie napätie 230 V ~ 50 Hz
- kombinácia so striedavým prepínačom nie je možná
- kombinácia s viacerými stmievačmi nie je povolená
- v súlade s normou EN 60669-1
- skrutkové upevnenie vodičov 1,5 – 2,5 mm²
- indikácia LED diódou



- DIMMER ROTATIVE R 300W 1M**
- rotation control without switch
 - type RTS34, 43 RVP, load R, 40W - 300W
 - supply voltage 230V ~ 50Hz
 - 2-way switch combination is not possible
 - more dimmers combination is not allowed
 - in accordance with EN 60669-1
 - screw contacts 1.5-2.5mm²
 - LED indication

STMIEVAČ ROTAČNÝ/STRIEDAVÝ RL 300 W 1M



- EM12PW
- EM12SB
- EM12AT
- EM12ES
- EM12IW

- ovládanie rotáciou so striedavým prepínačom
- zaťaženie RL, 40 W – 300W
- napájacie napätie 230 V ~ 50 Hz
- umožňuje kombináciu s ďalším striedavým prepínačom
- montáž viacerých zariadení spolu do jednej krabice je prípustná len za predpokladu, že ich celkový maximálny výkon neprekračuje maximálny výkon jedného stmievača
- v jednom obvode je povolené použitie len jedného stmievača
- istič nie je zabudovaný – použite externý istič
- v súlade s normou EN 60669-1
- skrutkové upevnenie vodičov – 1,5 – 2,5 mm²
- integrovaná LED indikácia úrovne stmievania

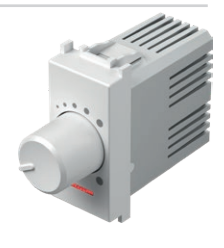

DIMMER ROTATIVE/2WAY RL 300W 1M

- rotation control with 2-way switch
- load RL, 40W - 300W
- supply voltage 230V ~ 50Hz
- 2-way switch combination is possible
- installing several devices together in one box is only permitted if their total maximum load does not exceed the maximum power of a single dimmer
- one circuit allows the use of only one dimmer
- no built-in fuse – external fuse must be used
- in accordance with EN 60669-1
- screw contacts - 1.5-2.5mm²
- integrated LED indication of dimming level



- EM13PW
- EM13SB
- EM13AT
- EM13ES
- EM13IW

STMIEVAČ ROTAČNÝ/STRIEDAVÝ LED 60 W 1M

- ovládanie rotáciou so striedavým prepínačom
- zaťaženie:
 - LED: 0 – 60 W (max. 6 stmievateľné LED žiarivky)
 - GLS: 0 – 60 W
- napájacie napätie 230 V ~ 50 Hz
- umožňuje kombináciu s ďalším striedavým prepínačom
- montáž viacerých zariadení spolu do jednej krabice je prípustná len za predpokladu, že ich celkový maximálny výkon neprekračuje maximálny výkon jedného stmievača
- v jednom obvode je povolené použitie len jedného stmievača
- istič nie je zabudovaný – použite externý istič
- v súlade s normou IEC60669-2-1
- skrutkové upevnenie vodičov – 1,5 – 2,5 mm²

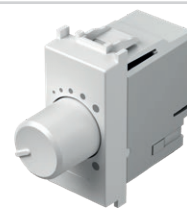

DIMMER ROTATIVE/2WAY LED 60W 1M

- rotation control with 2-way switch
- loads: LED, 0 – 60W (max. 6 dimmable LED lamps)
- GLS, 0 – 60W
- supply voltage 230V ~ 50Hz
- 2-way switch combination is possible
- installing several devices together in one box is only permitted if their total maximum load does not exceed the maximum power of a single dimmer
- one circuit allows the use of only one dimmer
- no built-in fuse – external fuse must be used
- in accordance with IEC60669-2-1
- screw contacts - 1.5-2.5mm²



- EM14PW
- EM14SB
- EM14AT
- EM14ES
- EM14IW

STMIEVAČ ROTAČNÝ/STRIEDAVÝ LED 180W 1M

- ovládanie rotáciou so striedavým prepínačom
- zaťaženie:
 - LED: 0 – 180W (max. 20 stmievateľné LED žiarivky)
 - GLS: 0 – 180W
- napájacie napätie 230 V ~ 50 Hz
- umožňuje kombináciu s ďalším striedavým prepínačom
- montáž viacerých zariadení spolu do jednej krabice je prípustná len za predpokladu, že ich celkový maximálny výkon neprekračuje maximálny výkon jedného stmievača
- v jednom obvode je povolené použitie len jedného stmievača
- istič nie je zabudovaný – použite externý istič
- v súlade s normou IEC60669-2-1
- skrutkové upevnenie vodičov – 1,5 – 2,5 mm²



DIMMER ROTATIVE/2WAY LED 180W 1M

- rotation control with 2-way switch
- loads:
 - LED, 0 – 180W (max. 20 dimmable LED lamps)
 - GLS, 0 – 180W
- supply voltage 230V ~ 50Hz
- 2-way switch combination is possible
- installing several devices together in one box is only permitted if their total maximum load does not exceed the maximum power of a single dimmer
- one circuit allows the use of only one dimmer
- no built-in fuse – external fuse must be used
- in accordance with IEC60669-2-1
- screw contacts - 1.5-2.5mm²



- EM15PW
- EM15SB
- EM15AT
- EM15ES
- EM15IW

STMIEVAČ ROTAČNÝ R 250 W 1M

- ovládanie rotácie bez prepínača
- typ RTS34.43 RVP, zaťaženie R, 40 W – 250 W
- napájacie napätie 230 V ~ 50 Hz
- kombinácia so striedavým prepínačom nie je možná
- kombinácia s viacerými stmievačmi nie je povolená
- v súlade s normou EN 60669-1
- skrutkové upevnenie vodičov 1,5 – 2,5 mm²
- indikácia LED diódou

DIMMER ROTATIVE R 250W 1M

- rotation control without switch
- type RTS34, 43 RVP, load R, 40W - 250W
- supply voltage 230V ~ 50Hz
- 2-way switch combination is not possible
- more dimmers combination is not allowed
- in accordance with EN 60669-1
- screw contacts 1.5-2.5mm²
- LED indication





EM23

ZABUDOVATEĽNÝ STMIEVAČ R (250 W), (EC, RL 200 VA)

- v schránke, ovládaný vonkajším tlačidlom
- zaťaženie RLC 15-250 W alebo 15-200 VA
- napájacie napätie 230 V ~ 50 Hz
- k dispozícii je niekoľko kombinácií tlačidiel
- kombinácia viacerých stmievačov nie je možná
- pamäť intenzity svetla
- jemná funkcia zapínania/vypínania
- nábehový stmievač
- v súlade s STN EN 60669, STN EN 60950, STN EN 61000, STN ETSI EN 300 220-1, STN ETSI EN 300 220-2
- káblové skrútkové spoje 2,5 mm²

DIMMER INBOX R (250 W), (RC, RL 200 VA)

- inbox, controlled by external push button
- load RLC 15-250W or 15-200 VA
- supply voltage 230V~ 50Hz
- several push-buttons combinations are possible
- more dimmers combination is not allowed
- light intensity memory
- soft start/stop function
- »leading edge«
- in accordance with EN60669, EN60950, EN 61000, ETSI EN 300 220-1, ETSI EN 300 220-2
- screw contacts to wires 2,5 mm²



EM18

ZABUDOVATEĽNÝ STMIEVAČ LED 250W

- zabudovateľný, ovládaný vonkajším tlačidlom
- nábehový alebo zostupový stmievač
- napájacie napätie 230 V ~ 50 Hz
- k dispozícii je niekoľko kombinácií tlačidiel
- zabudovaná pamäťová funkcia
- funkcia jemného zapnutia / vypnutia
- nastavenie minimálneho jasu
- inštalácia len jedného stmievača do jednej krabice
- len na použitie v interiéri
- v súlade s EN 60669-1 a EN 60669-2-1

DIMMER INBOX LED 250W

- inbox, controlled by external push button
- for leading or trailing edge
- supply voltage 230V~ 50Hz
- several push-buttons combinations is possible
- light intensity memory
- soft start / stop function
- minimum intensity control
- only one dimmer per wall box
- only for indoor usage
- in accordance with EN 60669-1 and EN 60669-2-1



EM19

ZABUDOVATEĽNÝ STMIEVAČ DC LED 96W

- zabudovateľný, ovládaný vonkajším tlačidlom
- zapojenie so všetkými LED predradníkmi s konštantným napätím a niektorými LED predradníkmi s konštantným prúdom, 9 - 48 V DC, max 96W (vhodné pre LED pásy)
- nie je určený na použitie s indukčnými záťažami
- možné zapojenie s viacerými tlačidlami a stmievačmi
- zabudovaná pamäťová funkcia
- funkcia jemného zapnutia / vypnutia
- inštalácia len jedného stmievača do jednej krabice
- len pre vnútorné použitie

DIMMER INBOX DC LED 96W

- inbox, controlled by external push button
- for use with constant voltage LED drivers and some constant current LED drivers, 9-48V DC, max 96W (also for LED strips)
- not for use with inductive loads
- several push-buttons combinations and several dimmers is possible
- light intensity memory
- soft start / stop function
- only one dimmer per wall box
- only for indoor usage

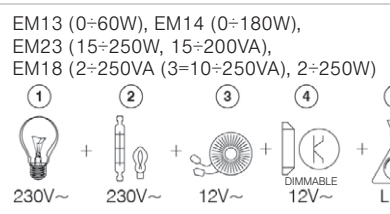
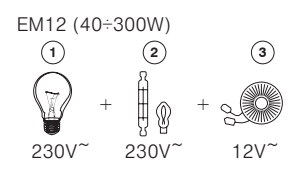
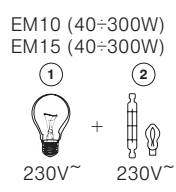

- 1 – žiarovka / incandescent lamp
- 2 – halogénová žiarovka halogen lamp
- 3 – klasický transformátor / classical transformer
- 4 – stmievateľný elektronický transformátor / dimmable electronic transformer
- 5 – stmievateľná LED žiarovka / dimmable LED lamp

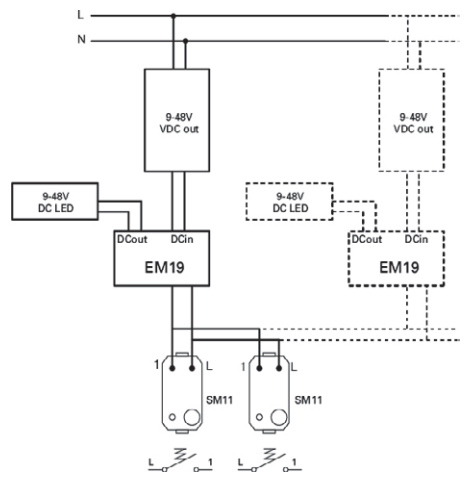
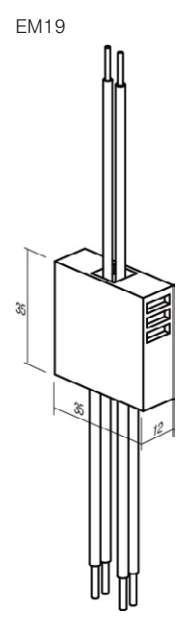
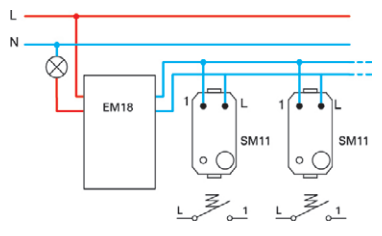
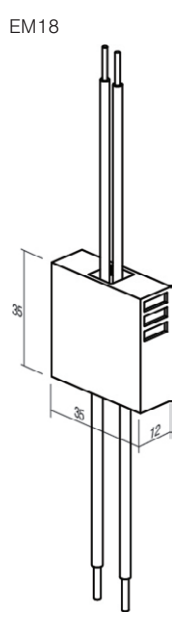
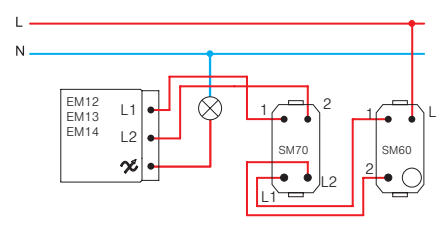
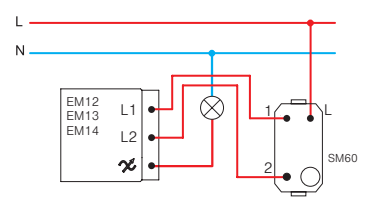
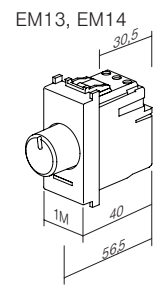
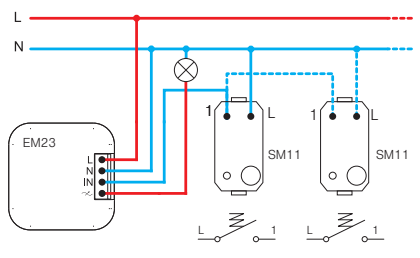
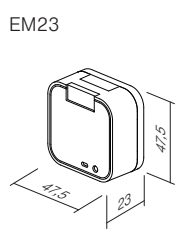
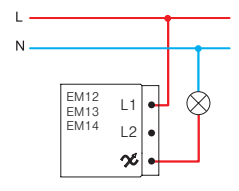
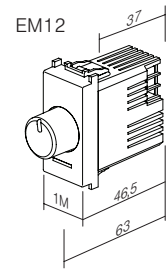
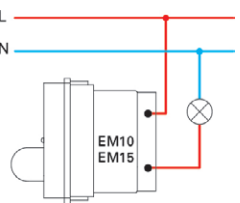
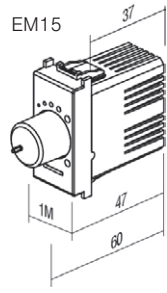
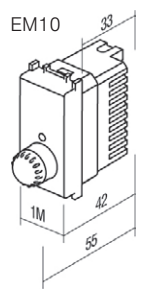

POZOR!
Ak sa do jednej krabice zapojí viac stmievačov, znížte maximálny spoločný výkon o 10 % pri každom stmievači.

ATTENTION!
If more dimmers are connected in one box reduce maximum common power for 10% for each dimmer.

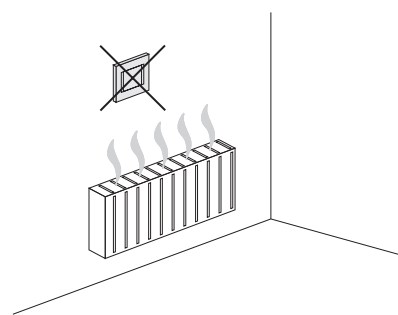



- EM25PW
- EM25SB
- EM25AT
- EM25ES
- EM25IW

TOUCH EM25 je mikroprocesorom riadený elektronický stmievač, ktorý slúži ako prepínač a stmievač pre stmievateľné a niektoré nestmievateľné zdroje svetla. Integrovaný mikroprocesor automaticky identifikuje typ svetelného zdroja a upraví prevádzkový režim. Po vypnutí si vďaka integrovanej pamäťovej funkcii zapamätá úroveň stmienia. Funkcia jemného zapnutia predlžuje životnosť svetelného zdroja. Elegantné LED osvetlenie integrované v tlačidle ponúka mnoho rôznych farieb a úrovni intenzity. Je možné pripojiť až 5 ďalších ovládacích tlačidiel EM26 („podriadených“).

TOUCH EM25 is microprocessor controlled electronic light dimmer. It serves as switch and dimmer for dimmable and some of non-dimmable lamps. Integrated microprocessor automatically identifies the type of lamp and adjusts the operating mode. It remembers the level of dimming after switching off due to integrated memory function. Soft-start function extends the lamp service life. In button integrated elegant LED illumination enables many different colours and intensity levels. Optionally one can connect up to 5 additional control tasters EM26 («slave»).

UNIVERZÁLNY STMIEVAČ RLC 0-300 W 2M

- univerzálny elektronický stmievač na zapnutie/vypnutie a stmievanie všetkých stmievateľných (klasické, halogénové, LED, CFL, ...) a niektorých nestmievateľných zdrojov svetla
- automatická detekcia typu svetelného zdroja a nastavenie prevádzkového režimu
- znižovanie spotreby energie
- funkcia jemného zapnutia predlžuje životnosť svetelného zdroja
- ovládanie zabudovanými mikrospínačmi
- súčasťou je pamäťová funkcia – zapamätá si nastavený jas pri vypnutí
- pripojených môže byť päť podriadených ovládacích jednotiek EM26
- spojenie so striedavým prepínačom nie je možné
- zabudovaná ochrana proti skratu, prehriatiu a preťaženiu
- napájacie napätie 230 V ~ 50 Hz
- elegantné LED osvetlenie, nastaviteľná farba a jas
- nahradenie klasického spínača je možné pri dvojvodičovom pripojení⁽¹⁾
- plná funkčnosť sa dosiahne pri trojvodičovom pripojení⁽²⁾
- v súlade s normami EN 60669-1 a STN EN 60669-2-1
- skrutkové upevnenie vodičov 1,5 mm² (max. utahovací moment 0,4 Nm)



SWITCH / DIMMER UNIVERSAL RLC 0-300W 2M

- universal electronic dimmer for ON/OFF switching and dimming of all dimmable lamps (classical, halogen, LED, CFL, ...) and some non-dimmable lamps
- automatic detection of lamp type and adjustment of operating mode
- reduction of energy consumption
- soft start function extends life of lamps
- controlled by build-in micro switches
- memory function included – memorizes brightness on turn-off
- up to five (5) additional control units EM26 can be connected
- connection with 2-way switch is not possible
- build-in short-circuit, overheating and overload protection
- supply voltage 230V ~ 50Hz
- elegant LED illumination, adjustable colour and brightness
- replacement of classical switch is possible at two-wire connection⁽¹⁾
- full functionality is achieved at three-wire connection⁽²⁾
- in accordance with EN 60669-1 and EN 60669-2-1
- screw contacts 1.5mm² (max. tightening torque 0.4Nm)

⁽¹⁾ dvojvodičové zapojenie
two-wire connection

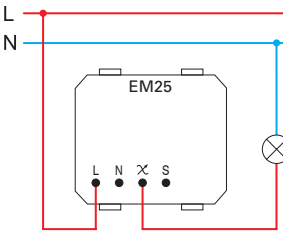

- dvojvodičové zapojenie umožňuje stmievanie stmievateľných žiaroviek a žiaroviek

- two-wire connection allows dimming of dimmable lamps

⁽²⁾ trojvodičové zapojenie
three-wire connection

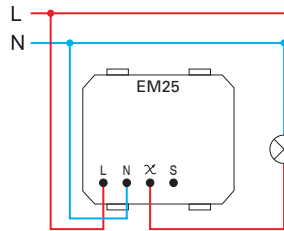

- trojvodičové zapojenie umožňuje stmievanie stmievateľných žiaroviek a niektorých nestmievateľných LED žiaroviek a CFL žiaroviek

- three-wire connection allows dimming of dimmable lamps and some of non-dimmable LED and CFL lamps

	1	2	5	6	7
Min.	40 W	40 W	40 VA	40 VA	40 VA
Max.	300 W	300 W	300 VA	100 VA	100 VA
	Ⓢ	Ⓢ	Ⓢ		

- 1 - žiarovka / incandescent lamp
- 2 - halogénová žiarovka / halogen lamp
- 5 - klasický transformátor / classical transformer
- 6 - stmievateľný elektronický transformátor / dimmable electronic transformer
- 7 - stmievateľná LED žiarovka / dimmable LED lamp

	1	2	4	6	7	8	9
Min.	0 W	0 W	0 VA	0 VA	0 VA	0 VA	0 VA
Max.	300 W	300 W	120 VA	120 VA	120 VA	120 VA	120 VA
	Ⓢ	Ⓢ	Ⓢ			Ⓢ	Ⓢ

- 4 - stmievateľná, úsporná CFL žiarovka / dimmable energy saving CFL lamp
- 6 - stmievateľná, úsporná CFL žiarovka / non-dimmable energy saving CFL lamp
- 7 - stmievateľná LED žiarovka / dimmable LED lamp
- 8 - nestmievateľná, úsporná CFL žiarovka / non-dimmable energy saving CFL lamp
- 9 - nestmievateľná LED žiarovka / non-dimmable LED lamp

poznámky / remarks

- Ⓢ filter EM27
- odporúča sa použiť filter EM27 / it is recommended to use filter EM27
- všetky regulované zdroje svetla musia byť rovnaké / all controlled lamps must be the same
- tabuľka zaťaženia sa týka svetelných zdrojov s účinkom PF > 0,5 / table of loads is valid for lamps with power factor PF>0.5

zapnutie/vypnutie a stmievanie svetla
on / off swithcing and dimming of lamp

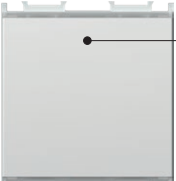

ZAP/VYP
krátke stlačenie
on / off
short press



rozsvietenie
dlhšie stlačenie
dimming up
long press



stmievanie
dlhšie stlačenie
dimming down
long press

Výber z LED farieb a nastavenie úrovne intenzity /
LED colour selection and intensity level adjustment



vypnutie svetla
krátke stlačenie
lamp off
short press



simultánne stlačenie ~ 3 s
integrovaná LED dióda 3 x zabliká
simultaneous press ~ 3s
integrated LED blinks 3
times



výber farieb
krátke stlačenie
colour selection
short press



rozsvietenie integrovanej LED
diódy dlhšie stlačenie
integrated LED dimming up
long press



stmievanie integrovanej LED diódy
dlhšie stlačenie
integrated LED dimming
down
long press

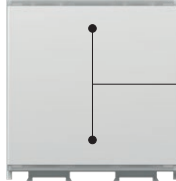

uloženie nastavenia – simultánne krátke stlačenie
integrovaná LED dióda 3 x zabliká
settings saving - simultaneous short
press
integrated LED blinks 3 times

* Funkcia resetovania /
"RESET" function



vypnutie svetla
krátke stlačenie
lamp off
short press



simultánne stlačenie ~ 3 s
integrovaná LED dióda 3 x zabliká
simultaneous press ~ 3s
integrated LED blinks 3
times

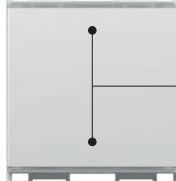

opakované simultánne stlačenie
~ 5 s
integrovaná LED dióda 5 x zabliká
re-simultaneous press ~ 5s
integrated LED blinks 5
times

- * - odporúča sa pri inštalácii stmievača a výmene žiarovky / žiarivky
- povinné pri použití nestmievateľných žiaroviek
- funkcia „RESET“ nie je možná pri použití dvojvodičového spojenia
- možné iba na EM25
- it is recommended at dimmer installation and lamp replacement
- mandatory when using non-dimmable lamps
- "RESET" function is not possible when using two-wire connection
- only possible on EM25

upozornenia pre inštaláciu
installation precautions

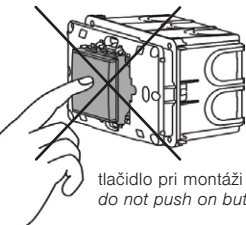
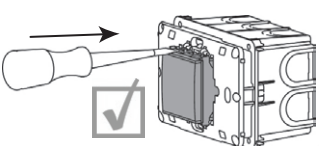
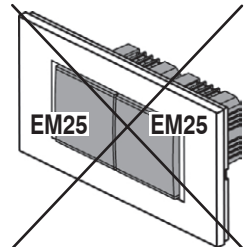
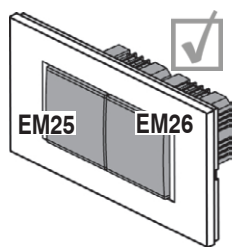

tlačidlo pri montáži nestláčajte /
do not push on button during mounting

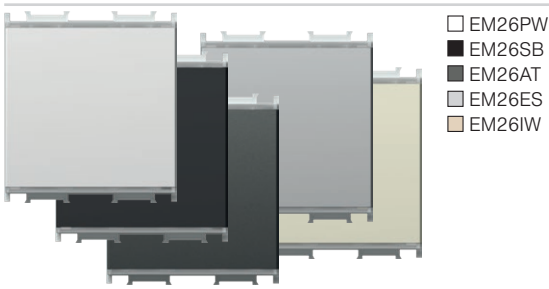

- EM26PW
- EM26SB
- EM26AT
- EM26ES
- EM26IW

OVLÁDACIA JEDNOTKA STMIEVAČA 2M

- pripojenie k univerzálnemu stmievaču EM25 umožňuje ovládanie zdrojov svetla s rovnakou funkčnosťou ako EM25
- napájacie napätie 230 V ~ 50 Hz
- v súlade s normami EN 60669-1 a STN EN 60669-2-1
- skrutkové upevnenie vodičov 1,5 mm² (max. uťahovací moment 0,4 Nm)

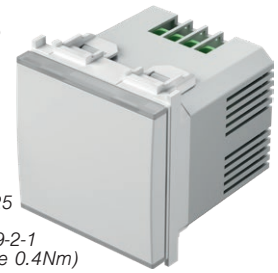

PUSH-BUTTON CONTROL UNIT 2M

- connected to universal dimmer EM25 allows controlling of lamps with same functionality as EM25
- supply voltage 230V ~ 50Hz
- in accordance with EN 60669-1 and EN 60669-2-1
- screw contacts 1.5mm² (max. tightening torque 0.4Nm)

(1) dvojvodičové zapojenie
two-wire connection

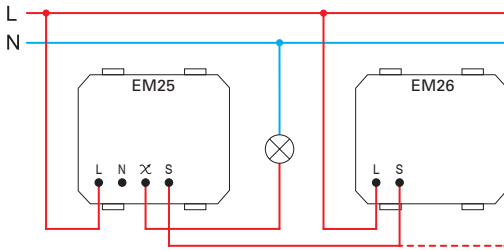

- dvojvodičové zapojenie umožňuje stmievanie stmievateľných žiaroviek a žiaroviek
- v dvojvodičovom zapojení každá ďalšia ovládací jednotka zvýši minimálne zaťaženie o 25 W
- two-wire connection allows dimming of dimmable lamps and light bulbs
- in a two-wire connection each additional control unit increases the minimum load by 25W

(2) trojvodičové zapojenie
three-wire connection

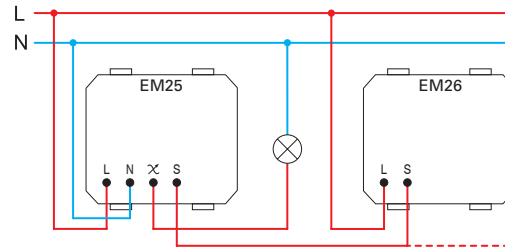

- trojvodičové zapojenie umožňuje stmievanie stmievateľných žiaroviek a niektorých nestmievateľných LED žiaroviek a CFL žiaroviek
- three-wire connection allows dimming of dimmable lamps and some of non-dimmable LED and CFL lamps

FREKVENČNÝ FILTER

EM27

- frekvenčný filter pre EM25
- obrázok je ilustračný

FREQUENCY FILTER

- frequency filter for EM25
- image is symbolic

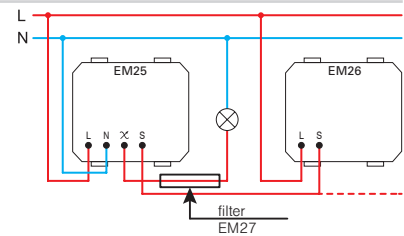

UNIVERZÁLNY STMIEVAČ RLC 0-300 W 2M PP OL20

□ EM25PPOL20

- súprava obsahuje stmievač EM25, montážny rám 2M a rámič LINE 2M PW
- pre technické podrobnosti pozri EM25

SET SWITCH / DIMMER UNIVERSAL RLC 0-300W 2M PP OL20

- set includes dimmer EM25, mounting frame 2M and cover plate LINE 2M PW
- for technical details see EM25

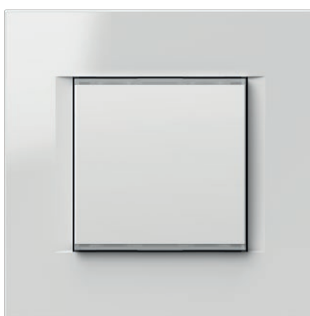

2M = 45 x 45

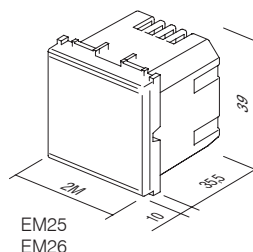

EM25
EM26



- EM31PW
- EM31SB
- EM31AT
- EM31ES
- EM31IW

IR SPÍNAČ 5 A 230 V ~ 1M

- infračervený spínač
- napájacie napätie: 230 V ~ ±10 % 50 Hz
- relé: 5 A/250 V ~ výstup pre obmedzený prúd s vysokou odolnosťou na prechod nulou
- stupeň krytia: IP40
- prierez vodiča na kontaktnjej svorke: 0,75 – 2,5 mm²
- uhol detekcie: až 110° pri 20 °C
- detekčná oblasť: pribl. 8 m pri 20 °C
- nastaviteľný čas zopnutia: od pribl. 5s do 12min
- nastaviteľnosť jasů: od pribl. 5 do 200 LUX
- prevádzková teplota: od 0 °C do + 40 °C
- nie je vhodný na montáž do krabíc s hĺbkou 45 mm a do krabice určenej pre povrchovú montáž CUBO IP20
- len pre použitie v interiéri



IR SWITCH 5A 230V~ 1M

- IR infrared switch
- supply voltage: 230V ~ ±10 % 50Hz
- relay: 5A / 250V ~ output for limited current with high resistance for zero crossing
- protection rating: IP40
- cross-section of wires at the contact terminal: 0.75 - 2.5 mm²
- detection angle: up to 110° at 20°C
- detection area: approx. 8 m at 20°C
- adjustability of duration: from approx. 5 s to 12 min
- adjustability of brightness: from approx. 5 to 200 LUX
- operating temperature: from 0°C to +40°C
- not suitable for installation in 45 mm deep boxes and surface mount box CUBO IP20
- only for indoor usage

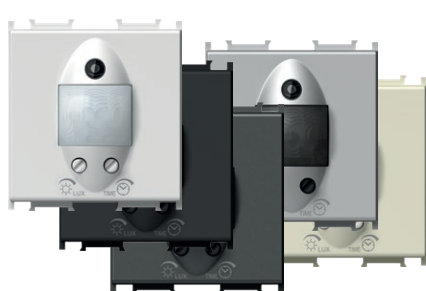

- EM32PW
- EM32SB
- EM32AT
- EM32ES
- EM32IW

IR SPÍNAČ 5 A 230 V ~ 2M

- infračervený spínač
- napájacie napätie: 230 V ~ ±10 % 50 Hz
- relé: 5 A/250 V ~ výstup pre obmedzený prúd s vysokou odolnosťou na prechod nulou
- stupeň krytia: IP40
- prierez vodiča na kontaktnjej svorke: 0,75 – 2,5 mm²
- uhol detekcie: až 110° pri 20 °C
- detekčná oblasť: pribl. 8 m pri 20 °C
- nastaviteľný čas zopnutia: od pribl. 5 s do 12 min
- nastaviteľnosť jasů: od pribl. 5 do 200 LUX
- prevádzková teplota: od 0 °C do + 40 °C
- nie je vhodný na montáž do krabíc s hĺbkou 45 mm a do krabice určenej pre povrchovú montáž CUBO IP20
- len pre použitie v interiéri



IR SWITCH 5A 230V~ 2M

- IR infrared switch
- supply voltage: 230V ~ ±10 % 50Hz
- relay: 5A / 250V ~ output for limited current with high resistance for zero crossing
- protection rating: IP40
- cross-section of wires at the contact terminal: 0.75 - 2.5 mm²
- detection angle: up to 110° at 20°C
- detection area: approx. 8 m at 20°C
- adjustability of duration: from approx. 5 s to 12 min
- adjustability of brightness: from approx. 5 to 200 LUX
- operating temperature: from 0°C to +40°C
- not suitable for installation in 45 mm deep boxes and surface mount box CUBO IP20
- only for indoor usage

rozsah snímania /
detection range

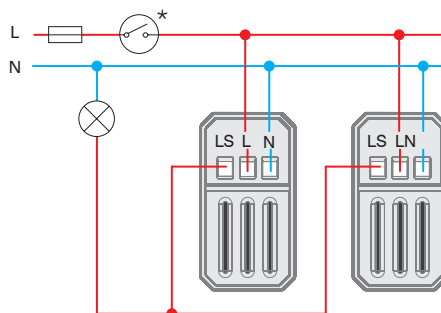
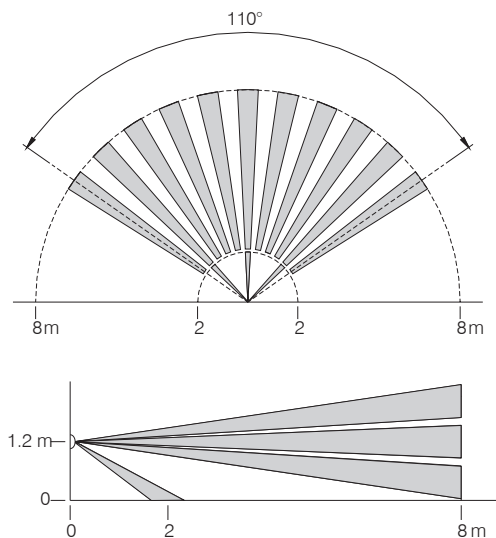

Nastavenie citlivosti a času osvetlenia
time and twilight adjustment

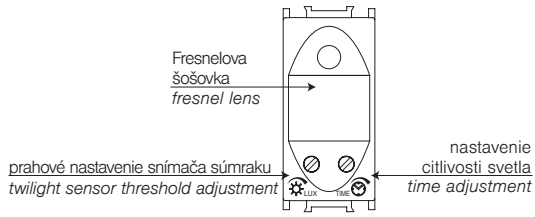

	~5 s	~12 min

	1	2	3	4	5	6	7	8
Min.	1 W	1 W		1 VA	1 W	1 W	1 VA	1 VA
Max.	800 W	800 W	5A	6x20 VA	6x36 W	4x36 W (20µF)	6x23 VA	6x20 VA

1 – žiarovka /
incandescent lamp

2 – halogénová žiarovka /
halogen lamp

3 – odporové vykurovacie teleso /
resistive heating element

4 – elektronický transformátor /
electronic transformer

5 – žiarivka (verzia 1) /
fluorescent tube (version 1)

6 – žiarivka (verzia 2) /
fluorescent tube (version 2)

7 – úsporná CFL žiarivka /
energy saving CFL lamp

8 – LED žiarivka /
LED lamp

upozornenia /
attention

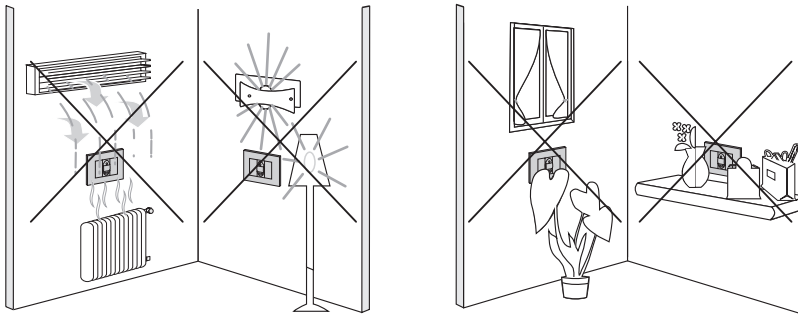

1M = 22,5 x 45

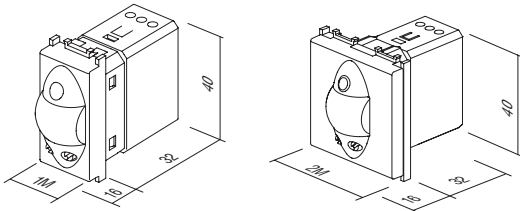

TERMOSTAT ZÁKLADNÝ 6 A 230 V ~ 2M



- EM37PW
- EM37SB
- EM37AT
- EM37ES
- EM37IW

- elektronický termostat, základný
- prevádzkový režim: vyhrievanie/chladienie/vypnutie
- napájaci zdroj: 230 V AC, 50 Hz
- výkon: 6 (2) A, 230 V AC, spínacie relé
- rozsah regulácie: 10 °C až 30 °C
- hysterezia: ±0,5 °C, ED = 20 min.
- ochrana proti zamrznutiu (režim vyhrievanie): +6 °C
- ochrana proti prehriatiu (režim chladienie): +32 °C
- funkcia ECO na zníženie teploty o 3 °C po dobu 6 hodín v režime vyhrievania a zvýšenie teploty o 3 °C po dobu 6 hodín v režime chladienia
- adaptívna funkcia ECO automaticky každý deň v rovnakom čase zníži teplotu o 3 °C po dobu 6 hodín v režime vyhrievania a zvýši teplotu o 3 °C po dobu 6 hodín v režime chladienia
- možnosť zapnúť prevádzkový režim ECO pomocou externého spínača cez samostatný vstup
- LED indikácia prevádzky
- nie je vhodný pre elektrické podlahové kúrenie
- skrutkové upevnenie vodičov max. 2,5 mm²
- v súlade s NN a EMK smernicou, normami EN60730-1 a EN60730-2-9
- pre správnu funkciu odporúčame inštalovať do samostatnej jednoduchkej krabice oddelenej od zariadení, ktoré generujú teplo
- prevádzková teplota: 5 ÷ 35 °C
- skladovacia teplota: -20 ÷ 50 °C



Termostat je určený na reguláciu teploty v miestnosti. Termostat umožňuje dva režimy prevádzky – vykurovanie alebo chladienie. Jeho bezpečnostné funkcie sú inštalované na ochranu proti zamrznutiu (režim vykurovania) a ochranu proti prehriatiu (režim chladienia). Prevádzka je indikovaná pomocou LED diód. Nastavenie termostatu sa vykonáva za pomoci otočného ovládača na nastavenie teploty a ďalších kapacitných tlačidiel.

The thermostat is intended for regulating temperature in a room. A thermostat enables two modes of operation – heating or cooling. It has safety functions installed for protection against freezing (heating mode) and protection against overheating (cooling mode). The operation is indicated via LED lights. Thermostat setup is performed with the help of a rotary button for setting the temperature and with other capacitive touch buttons.

THERMOSTAT BASIC 6A 230 V ~ 2M

- electronic thermostat, basic
- operation mode: heating/cooling/turn off
- power supply: 230 VAC, 50 Hz
- output: 6(2) A, 230 VAC, relay switch
- regulation range: +10 °C to +30 °C
- hysteresis: ±0.5 °C, ED = 20min
- anti-freeze protection (heating mode): +6 °C
- overheating protection (cooling mode): +32 °C
- ECO function for lowering the temperature by 3 °C for 6 hours in the heating mode and raising temperature by 3 °C for 6 hours in the cooling mode
- adaptive ECO function, automatically every day at the same time lowers the temperature by 3 °C for 6 hours in the heating mode and raises temperature by 3 °C for 6 hours in the cooling mode
- option to turn on the ECO operating mode by external trigger via a separate input
- LED indication of operation
- not suitable for electrical floor heating
- screw contacts max. 2.5 mm²
- in accordance with the LV Directive, the EMC Directive, standards EN60730-1 and EN60730-2-9
- for correct operation, we recommend installing in an independent single box, separate from devices that generate heat
- operating temperature: 5 ÷ 35 °C
- storage temperature: -20 ÷ 50 °C

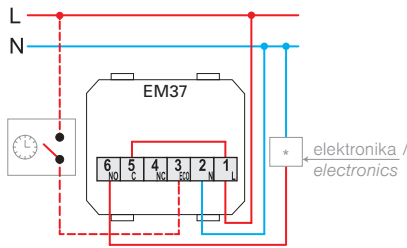

obehové čerpadlo, horák (priame pripojenie)
thermoelektrický pohon /
circulation pump, burner (direct connection)
thermoelectric drive

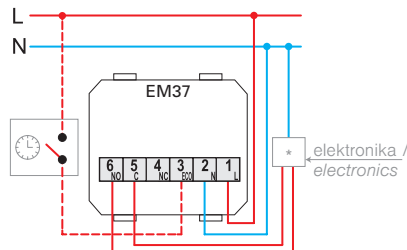

kotel, tepelné čerpadlo, horák (riadiaci vstup T1/T2) /
boiler, heat pump, burner (control input T1/T2)

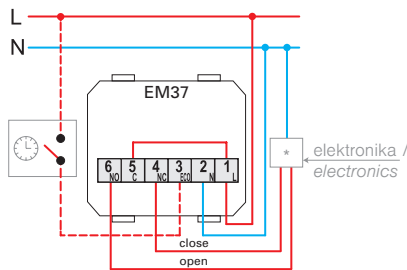

pohon motorčeka (obmedzené použitie pri podlahovom kúrení) /
motor drive (limited use with underfloor heating)

2M = 45 x 45

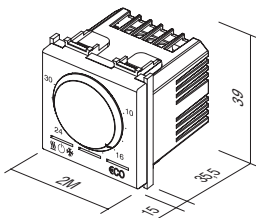

nastavenie činnosti a teploty /
function and temperature adjustment

funkčné tlačidlo pre výber a LED
indikátor stavu:

- červená: vykurovanie
- modrá: klimatizácia
- nesvieti: vypnuté

function selection button and
LED status indicator:

- red: heating
- blue: air conditioning
- no light: switched off

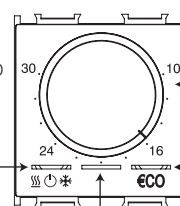

nastavenie činnosti a teploty
temperature setting

Tlačidlo pre výber funkcie „ECO“ a LED
indikátor stavu „ECO“
zelená: úsporná funkcia ECO zapnutá
oranžová: adaptívny režim ECO aktivovaný
nesvieti: denný režim

“ECO” function selection button and
LED “ECO” status indicator

- green: ECO energy saving ON
- orange: adaptive ECO mode activated
- no light: day mode

LED indikátor stavu výstupného relé
biela: relé ZAP
nesvieti: relé VYP

LED output relay state indicator
white: relay ON
no light: relay OFF

upozornenia/
attention

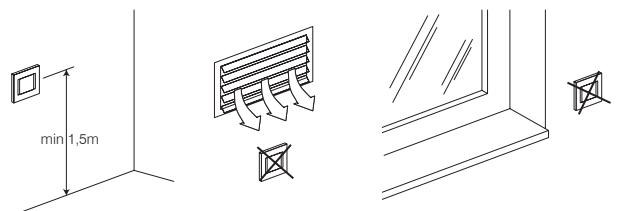

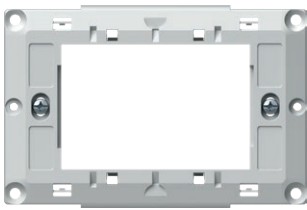

NM39

MONTÁŽNY RÁMIK SO SKRUTKAMI PRE TERMOSTATY FANTINI COSMI 3M

- montážny rámik so skrutkami pre termostaty Fantini Cosmi 3M
- vhodný na použitie s dennými termostatmi Fantini Cosmi, modely CH121 a CH123
- vhodný na použitie s týždennými termostatmi Fantini Cosmi, modely CH141A a CH143A
- pre montáž do obdĺžnikových krabic 3M
- na montáž s rámkami rady PURE, Line, Soft



MOUNTING FRAME WITH SCREWS FOR FANTINI COSMI THERMOSTATS 3M

- mounting frame with screws for Fantini Cosmi thermostats 3M
- suitable for use with Fantini Cosmi daily thermostats models CH121 and CH123
- suitable for use with Fantini Cosmi weekly thermostats models CH141A and CH143A
- for mounting in rectangular boxes 3M
- suitable for assembling with cover plates PURE, Line, Soft



- EM40PW
- EM40SB
- EM40AT
- EM40ES
- EM40IW

KARTOVÝ SPÍNAČ JEDNOTKY PRE ÚSPORU ENERGIE 3 A 250 V ~ 3M

- kartový spínač základný, akákoľvek ISO karta
- napájacie napätie 230 V ~ 50 Hz
- výstup 3 A 250 V ~ pre spínací stýkač*
- oneskorenie vypnutia 15 – 20 s
- v súlade s normou EN 61000-6-1
- karta nie je priložená
- nie je určené na riadenie vstupu



ENERGY SAVER CARD SWITCH 3A 250V~ 3M

- card switch basic, any ISO card
- supply voltage 230V~ 50Hz
- output 3A 250V~ for switching contactor *
- switch off delay 15-20s
- in accordance with EN 61000-6-1
- card is not included
- not for access control

3M = 67,5 x 45

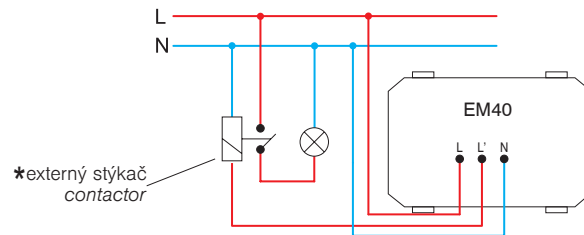
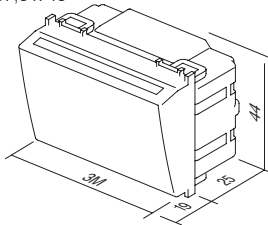

KARTA ISO

EM47

- ISO karta
- na použitie s kartovým spínačom EM40
- veľkosť: 85 x 54 mm

CARD ISO

- ISO card
- for combination with card switch EM40
- size: 85x54 mm

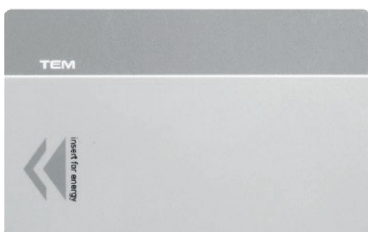



EM44BK

KARTOVÝ SPÍNAČ JEDNOTKY PRE ÚSPORU ENERGIE RF HF 13,56 MHz 3M

- elektronický kartový spínač pre kartu ISO RFID
- napájanie z relé jednotky EM49 cez káblové konektory RJ12
- výstup pre pripojenie na jednotku reléového výstupu EM49
- 15-20s oneskorenie vypnutia „hlavného napájania“ po vytiahnutí karty
- 1-minútové oneskorenie vypnutia VZT po vybratí karty, ak sú balkónové dvere alebo okná otvorené
- v súlade s normou EN 61000-6-1
- karta nie je priložená
- nie je určené na riadenie vstupu

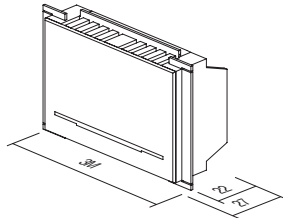

ENERGY SAVER CARD SWITCH RF HF 13,56MHz 3M

- electronic card switch for RFID ISO card
- supply from relay unit EM49 through cable connectors RJ12
- output to be connected to relay output unit EM49
- 15-20s "main power" switch off delay with card withdrawal
- 1 min "HVAC" switch off delay with card withdrawal when balcony doors or windows opened
- in accordance with EN 61000-6-1
- card is not included
- not for access control

OVLÁDAČ JEDNOTKY PRE ÚSPORU ENERGIE 2 x 16 250 V~

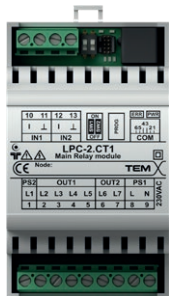

EM49

- relé jednotka pre kartové vypínače EM44
- napájacie napätie 230 V ~ 50 Hz
- v súlade s normou EN 61000-6-1
- montáž na DIN 35 mm lištu, 3MU
- vstup a výstup v závislosti na realizácii: jedna miestnosť alebo dve miestnosti

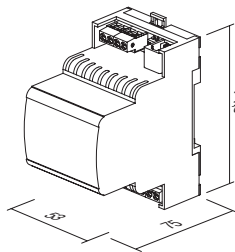

ENERGY SAVER CONTROL UNIT 2x16A 250V~

- relay unit for card switches EM44
- supply voltage 230V~ 50Hz
- in accordance with EN 61000-6-1
- mounting on DIN rail 35mm, 3MU
- input and output depending on implementation: single or double room

ROZDEĽOVAČ SPL-1

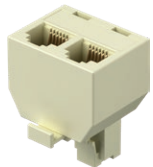

EM45

- slúži na pripojenie dvoch periférnych modulov EM44 k relé jednotke EM49
- komunikačný konektor RJ12
- veľkosť: 37 x 30 x 27 mm

SPLITTER SPL-1

- used to connect two peripheral modules EM44 to relay unit EM49
- communication connector RJ12
- size: 37 x 30 x 27 mm

schéma zapojenia pre realizáciu v jednej miestnosti / wiring diagram for single room implementation



schéma zapojenia pre realizáciu v dvoch miestnostiach / wiring diagram for double room implementation



kábel RJ12 pre prepojenie EM44 a EM49 / connection cable RJ12 between EM44 and EM49



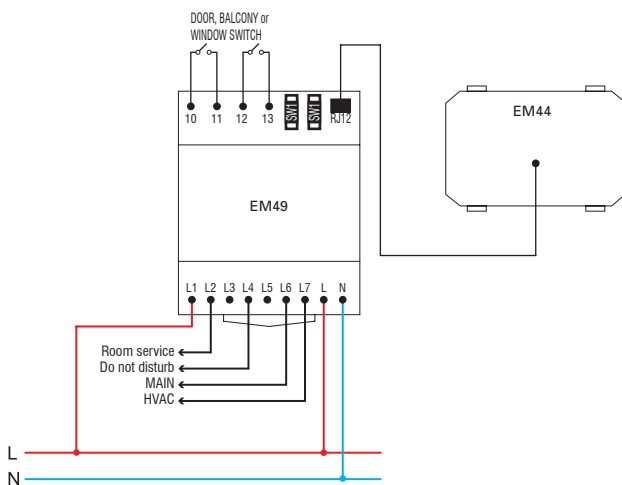
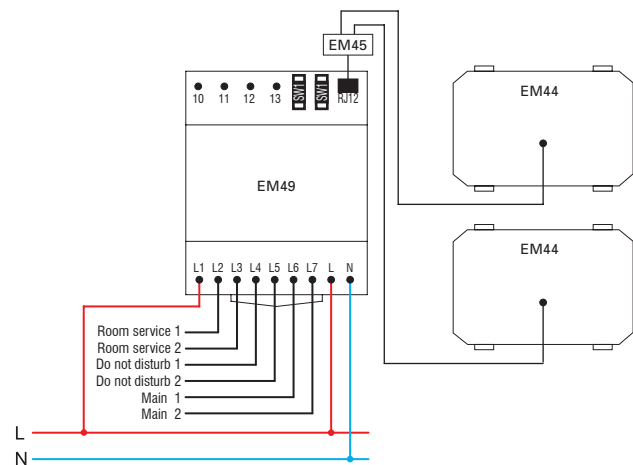
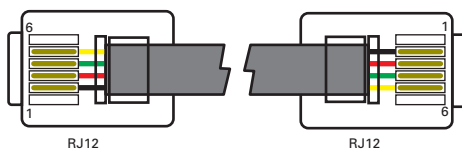

- EM60PW
- EM60SB
- EM60AT
- EM60ES
- EM60IW

ZÁSUVKA NA HOLIACI STROJČEK 230 V ~/120 V ~ 3M

- jednotka napájania holiaceho strojčeka s izoláčnym transformátorom 20 VA
- napájanie: 230 V ~ 50- 60 Hz
- výkon: 230 V ~ pre európsku zástrčku 2P 2,5 A alebo 120 V ~ pre americkú zástrčku 2P 15 A
- trieda II
- v súlade s normou EN 61558-2-5



SOCKET SHAVER 230V~/120V~ 3M

- shaver supply unit with isolating transformer 20VA
- supply: 230V~ 50-60Hz
- output: 230V~ for 2P 2.5A Europlug or 120V~ for 2P 15A American plug
- Class II
- in accordance with EN 61558-2-5

3M = 67,5 x 45

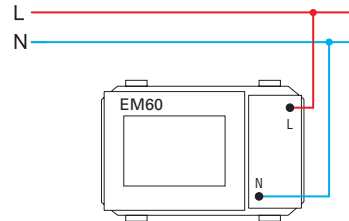
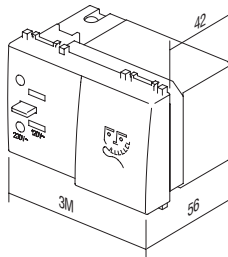

- EM66PW
- EM66SB
- EM66AT
- EM66ES
- EM66IW

NABÍJACIA JEDNOTKA USB 5V 2,1A 1M

- na nabíjanie elektronických zariadení cez štandardný USB port (kompatibilný aj so zariadeniami Apple)
- napájací zdroj: 100 – 230 V~ 50/60 Hz
- spotreba energie: 300 mA pri 100 V~ / 150 mA pri 230 V~
- spotreba energie v pohotovostnom režime: 30 mW pri 230 V~
- menovité výstupné napätie: 5 VDC (±5 %) SELV
- kolísanie výstupného napätia: 150 mV
- menovitý výstupný prúd: 2,1 A (1 x 2 100 mA) (±10 %)
- účinnosť: max. 77 %
- prevádzková teplota: 0 °C/+45 °C (použitie v interiéri)
- trieda ochrany IP: IP 20, iba na použitie v interiéri
- zariadenie bezpečnostnej triedy II
- kategória prepätovej ochrany (EN 62109): trieda III
- skrutkové upevnenie vodičov: max. 2,5 mm²
- zariadenia s medzerou kontaktov min. 3 mm
- v súlade s normou EN 60950-1 a smernice LVD a EMC

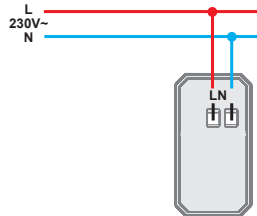
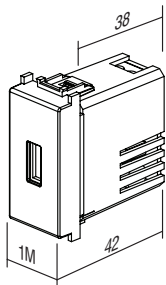

USB POWER SUPPLY UNIT 5V 2,1A 1M

- for charging of electronic devices via a standard USB port (also compatible with Apple devices)
- power supply: 100-230V~ 50/60Hz
- power consumption: 300mA at 100V~/150mA at 230V~
- standby power consumption: 30mW at 230V~
- nominal output voltage: 5 VDC (± 5%) SELV
- output ripple voltage: 150mV
- nominal output current: 2,1A (1 x 2.100mA) (±10%)
- efficiency: maximum of 77%
- operating temperature: 0°C/+45°C (indoor use)
- IP protection class: IP20, indoor use only
- class device II
- overvoltage category (EN 62109): Class III
- screw contacts: max. 2.5 mm²
- device with a contact gap of at least 3mm
- in accordance with EN 60950-1 and LVD & EMC directives

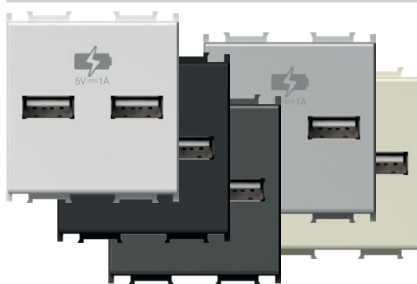

- EM65PW
- EM65SB
- EM65AT
- EM65ES
- EM65IW

NABÍJACIA JEDNOTKA USB 5V 1 A 2M

- na nabíjanie elektronických zariadení cez štandardný USB port (kompatibilný aj so zariadeniami značky Apple)
- umožňuje nabíjanie až dvoch zariadení naraz
- napájací zdroj: 230 V ~ 50 Hz
- spotreba záložného zdroja: 50 mW pri 230 V ~
- menovité výstupné napätie: 5 V DC (±5 %) SELV
- kolísanie výstupného napätia: 150 mV
- menovitý výstupný prúd: 1 A (1 x 1,000 mA alebo 2 x 500 mA) (±10 %)
- účinnosť: viac ako 67 %
- trieda ochrany IP: iba IP20, iba pre použitie v interiéri
- skrutkové upevnenie vodičov: max. 2,5 mm²
- v súlade s normou EN 60950-1 a smernicou o EMK
- za súčasť inštalácie musí byť považované vhodné externé odpojovacie zariadenie



2M = 45 x 45

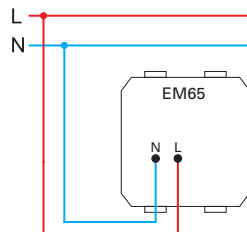
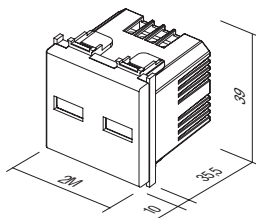

POWER SUPPLY UNIT USB 5V 1A 2M

- for charging of electronic devices via a standard USB port (also compatible with Apple devices)
- enables charging of two devices simultaneously
- power supply: 230V~ 50Hz
- stand-by power consumption: 50 mW at 230V~
- nominal output voltage: 5 VDC (±5%) SELV
- output ripple voltage: 150 mV
- nominal output current: 1 A (1 x 1.000 mA or 2 x 500 mA) (±10%)
- efficiency: greater than 67%
- IP protection class: IP20, indoor use only
- screw contacts: max. 2.5 mm²
- in accordance with EN 60950-1 and EMC directive
- an appropriate external disconnect device needs to be considered as part of installation



- EM67PW
- EM67SB
- EM67AT
- EM67ES
- EM67IW

NABÍJACIA JEDNOTKA USB 5V 2,4A 1M

- na nabíjanie elektronických zariadení cez štandardný USB port (kompatibilný aj so zariadeniami Apple)
- napájací zdroj: 100 ~ 230 V~ 50/60 Hz
- spotreba energie: 300 mA pri 100 V~ / 150 mA pri 230 V~
- spotreba energie v pohotovostnom režime: 30 mW pri 230 V~
- menovité výstupné napätie: 5 VDC ($\pm 5\%$) SELV
- kolísanie výstupného napätia: 150 mV
- menovitý výstupný prúd: 2,4 A ($\pm 10\%$)
- účinnosť: max. 77 %
- prevádzková teplota: 0 °C/+45 °C (použitie v interiéri)
- trieda ochrany IP: IP 20, iba na použitie v interiéri
- zariadenie bezpečnostnej triedy II
- kategória prepáťovej ochrany (EN 62109): trieda III
- skrutkové upevnenie vodičov: max. 2,5 mm²
- zariadenia s medzerou kontaktu min. 3 mm
- v súlade s normou EN 60950-1 a smernice NN a EMC

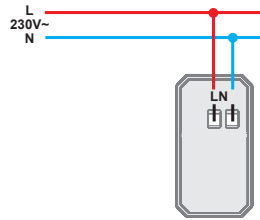
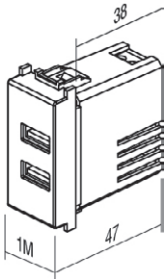

USB POWER SUPPLY UNIT 5V 2,4A 1M

- for charging of electronic devices via a standard USB port (also compatible with Apple devices)
- power supply: 100-230V~ 50/60Hz
- power consumption: 300mA at 100V~/150mA at 230V~
- standby power consumption: 30mW at 230V~
- nominal output voltage: 5 VDC ($\pm 5\%$) SELV
- output ripple voltage: 150mV
- nominal output current: 2,4A ($\pm 10\%$)
- efficiency: maximum of 77%
- operating temperature: 0°C/+45°C (indoor use)
- IP protection class: IP20, indoor use only
- class device II
- overvoltage category (EN 62109): Class III
- screw contacts: max. 2.5 mm²
- device with a contact gap of at least 3mm
- in accordance with EN 60950-1 and LVD & EMC directives

LED NÚDZOVÉ OSVETLENIE 250 V ~ 0,9W, Ni-Cd 3 h 7M

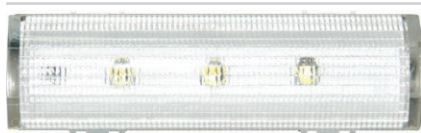

- EM55

- núdzový svetelný LED zdroj
- napájacie napätie 250 V ~ 50 Hz 3 x LED 0,3 W 10000mcd, 6500K
- NiCd akumulátor 400 mAh, vymeniteľný
- autonómny režim 3hod, nabíjanie 24 hod.
- trieda II
- v súlade s normami EN 60598-1, STN EN 60598-2-2, EN 60598-2-22



LED EMERGENCY LIGHT 250V~ 0.90W, NiCd 3h 7M

- emergency LED lamp
- supply voltage 250V~ 50Hz 3x LED 0,3W, 10000mcd, 6500K
- NiCd accumulator 400 mAh, replaceable
- autonomy 3h, charging 24h
- Class II
- in accordance with EN 60598-1, EN 60598-2-2, EN 60598-2-22

7M = 151,5 x 45

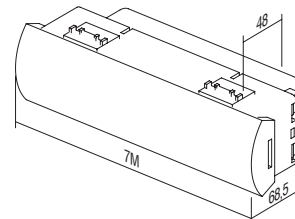
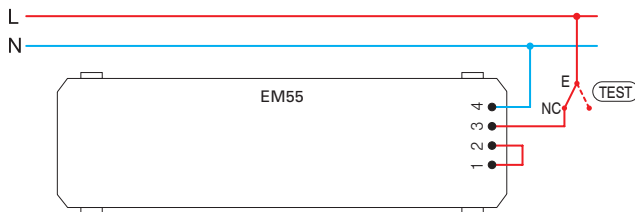

LED NÚDZOVÉ OSVETLENIE 230 V ~ 0,5W, NiMH 2 h 2M



- EM57

- núdzový svetelný LED zdroj
- použiteľné ako prenosné ručné svetidlo (vyťahovací mechanizmus)
- napájacie napätie 230 V ~ 50 Hz 1 x LED 0,5 W
- NiMH akumulátor 140 mAh, vymeniteľný
- autonómny režim 2hod, nabíjanie 36 hod.
- trieda II
- v súlade s normami EN60598-1, EN60598-2-2, EN62471, EN55015:2006, EN61547 EN 60598-2-22

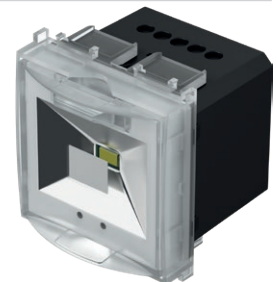

LED EMERGENCY LIGHT 230V~50Hz, 0.5W, NiMH 2h 2M

- emergency LED lamp
- option to use it as a hand lamp (pull-out mechanism)
- supply voltage 230V~ 50Hz, 1xLED 0.5W
- NiMH accumulator 140mAh, replaceable
- autonomy 2h, charging 36h
- class device II
- in accordance EN60598-1, EN60598-2-2, EN62471, EN55015:2006, EN61547

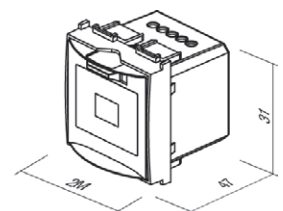
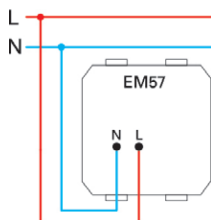

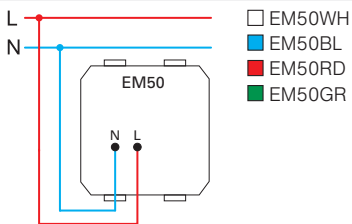
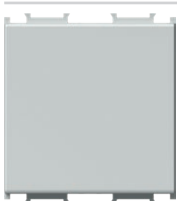

- EM50WH
- EM50BL
- EM50RD
- EM50GR

SVIETIDLO LED JEDNOFAREBNÉ 250 V ~ 0,8 W 2M

- LED svietidlo pre osvetľovanie schodísk alebo chodieb
- napájacie napätie 230 V ~ 50 Hz 0,8 W, 6500K
- trieda II
- v súlade s normou EN 60598-1
- využitie aj pre orientačné alebo signalizačné osvetlenie s možnosťou laserovej tlače ľubovoľného symbolu

LED LAMP MONOCOLOR 250V~ 0,8W 2M

- step marker LED lamp
- supply voltage 230V~ 50Hz 0,8W, 6500K
- Class II
- in accordance with EN 60598-1
- optional usage for directional or signal illumination with customized laser printing on diffuser

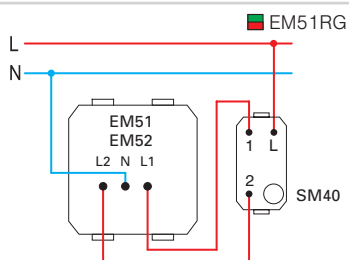

- EM51RG

SVIETIDLO LED DVOJFAREBNÉ 250 V ~ 2 x 0,4 W 2M

- signalizačné, dvojfarebné (červeno-zelené) LED svietidlo
- napájacie napätie 230 V ~ 50 Hz 2 x 0,4 W, 6500K
- trieda II
- v súlade s normou EN 60598-1
- difúzor obsahuje grafiku, ako je zobrazené na obrázku
- možnosť laserovej tlače na difúzore

LED LAMP DUAL COLOR 250V~ 2x0,4W 2M

- signaling dual color (red/green) LED lamp
- supply voltage 230V~ 50Hz 2x0,4W, 6500K
- Class II
- in accordance with EN 60598-1
- diffuser includes graphics as shown
- possible customized laser printing on diffuser

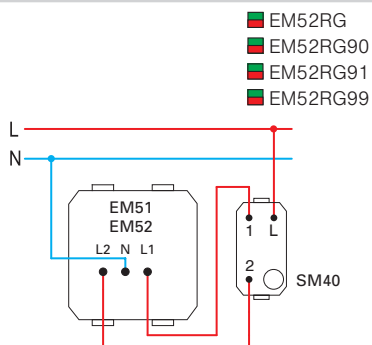

- EM52RG
- EM52RG90
- EM52RG91
- EM52RG99

3D SVIETIDLO LED DVOJFAREBNÉ 250 V ~ 2 x 0,4 W 2M

- signalizačné LED svietidlo, dvojfarebné (červeno-zelené) s 3D symbolom
- napájacie napätie 230 V ~ 50 Hz 2 x 0,4 W, 6500K
- trieda II
- v súlade s normou EN 60598-1
- prispôbitelná grafika na vyžiadanie
- 90 symbol muž, 91 symbol žena, 99 symbol na vyžiadanie

LED LAMP 3D DUAL COLOR 250V~ 2x0,4W 2M

- signalling LED lamp, dual color (red/green) with 3D symbol
- supply voltage 230V~ 50Hz 2x0,4W, 6500K
- class II
- in accordance with EN 60598-1
- possible customized graphics on request
- 90 male symbol, 91 female symbol, 99 symbol on request

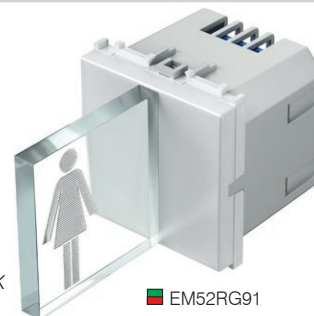

■ EM52RG91

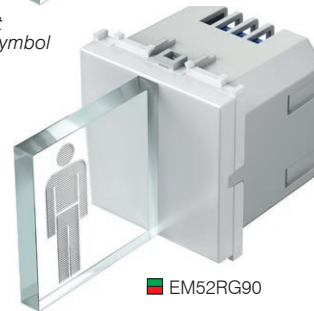

■ EM52RG90

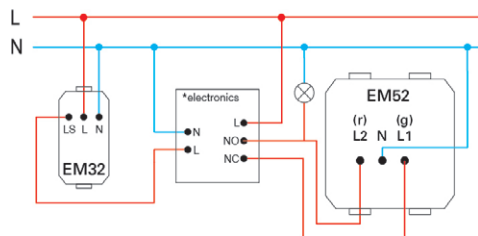

2M = 45 x 45

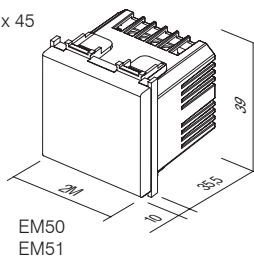

EM50
EM51

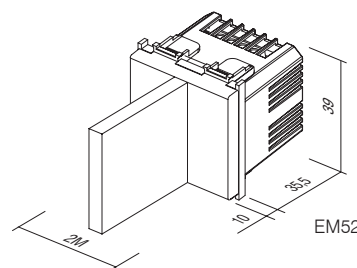

EM52



- EM71PW
- EM71SB
- EM71AT
- EM71ES
- EM71IW

SPÍNAČ NA ODTLAČKY PRSTOV BIOPASS 2M

- Spínač na odtlačky prstov so zabudovanou vnútornou relé jednotkou a napájaním
- Kapacita: 500 odtlačkov prstov
- Jednoduché používanie prostredníctvom mobilnej aplikácie X-Manager
- Napájacie napätie: 8-30 V – DC alebo AC (napájací zdroj priložený)
- Kapacitný snímač
- 2x výstupné relé
- Maximálne napätie/prúd na relé: 40V/3A
- Čas spustenia relé: 1 - 10 s
- Maximálny výkon: 3,6 W
- 256-bitové šifrovanie spojenia medzi spínačom a vnútornou jednotkou relé
- Súprava obsahuje aj montážny rám NM24 a dekoratívny rámik OS20



FINGERPRINT SWITCH BIOPASS 2M

- fingerprint switch with included internal relay unit and power supply
- capacity: 500 fingerprints
- easy management via X-Manager mobile app
- power supply voltage: 8-30V – DC or AC (power supply included)
- capacitive sensor
- 2 output relays
- maximum voltage/current on relay: 40V/3A
- relay triggering time: 1-10 sec
- maximum power: 3.6W
- 256-bit encrypted link between switch and internal relay unit
- Set also includes NM24 mounting frame and OS20 decorative cover plate.

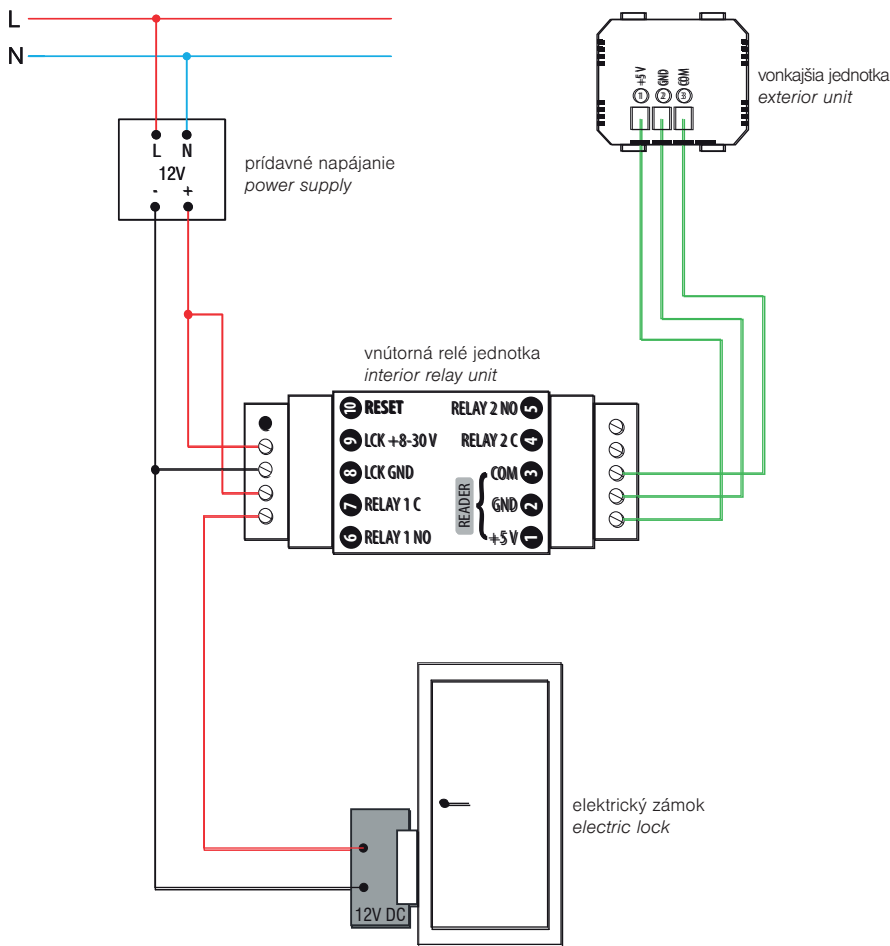

X-Manager app



support.tem.si



vonkajšia jednotka
exterior unit

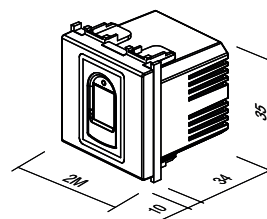



EM80GW

BEZDOTYKOVÝ SPÍNAČ 10 A 240 V ~

- bezdotykový spínač pre zapnutie/vypnutie („hlavný“)
- napájací zdroj: 240 V ~ 50 Hz
- výstupné relé 10 A/250 V~ (2400 W na 240 V ~)
- nastaviteľné v rozmedzí od 2 do 10 cm
- určené pre montáž do štandardnej okrúhlej krabice s priemerom Ø 60 mm
- pre zapojenie je potrebný neutrálny vodič (N)
- spojenie s prepínačmi nie je možné
- možné je zapojenie až s 5 ovládacími spínačmi EM81
- jednoduchá montáž dekoratívnych krytov pomocou magnetov
- skrutkové upevnenie vodičov do 2,5 mm² (max. ťahovací moment skrutky je 0,4 Nm)
- v súlade s normami EN 60669-1 a STN EN 60669-2-1
- určené len na používanie v interiéroch



SWITCH, TOUCHLESS 10A 240V~

- touchless switch for turning on/off ("master")
- power supply: 240 V~ 50 Hz
- output relay 10A / 250V~ (2400W at 240V~)
- adjustable range from 2 to 10 cm
- intended for installation into a standard round Ø60 mm box
- a neutral lead (N) is required for connection
- connection with toggle switches is not possible
- connection with up to 5 EM81 control switches is possible
- simple installation of decorative covers with the help of magnets
- screw fastening of leads up to 2.5 mm² (max. screw tightening torque is 0.4 Nm)
- in accordance with EN 60669-1 and EN 60669-2-1
- only for indoor use



EM81GW

BEZDOTYKOVÝ SPÍNAČ, OVLÁDACIA JEDNOTKA

- ovládací spínač („podriadený“)
- funguje len pri zapojení k vypínaču EM80 („hlavný“)
- nastaviteľné v rozmedzí od 2 do 10 cm
- jednoduchá montáž dekoratívnych krytov pomocou magnetov
- skrutkové upevnenie vodičov do 2,5 mm² (max. ťahovací moment skrutky je 0,4 Nm)
- v súlade s normami EN 60669-1 a STN EN 60669-2-1
- určené len na používanie v interiéroch

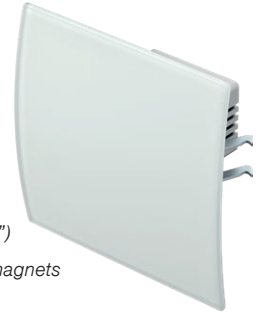

SWITCH, TOUCHLESS, CONTROL UNIT

- control switch ("slave")
- works only when connected with the EM80 switch ("master")
- adjustable range from 2 to 10 cm
- simple installation of decorative covers with the help of magnets
- screw fastening of leads up to 2.5 mm² (max. screw tightening torque is 0.4 Nm)
- in accordance with EN 60669-1 and EN 60669-2-1
- only for indoor use

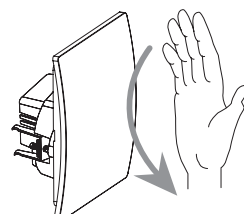
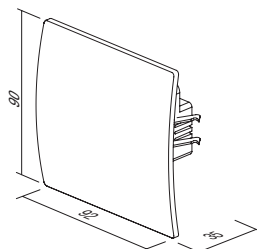
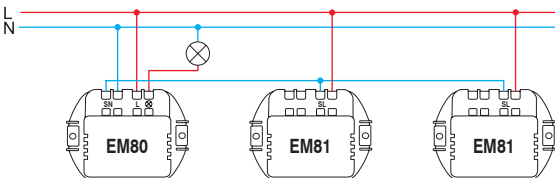
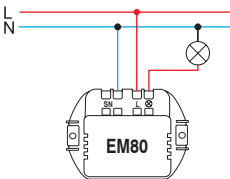

BZUČIAK 8 VA 230 V ~ 1M

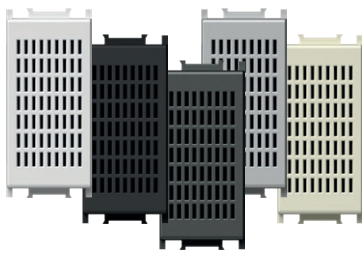

- EM90PW
- EM90SB
- EM90AT
- EM90ES
- EM90IW

- signálny bzučiak
- dĺžka zvukového signálu je rovnaká ako dĺžka stlačenia tlačidla
- napájacie napätie 230 V~ 50 Hz 8 VA

Buzzer 8VA 230V~1M

- signal buzzer
- the sound emission has the same lasting time as the control operation
- supply voltage 230V~ 50Hz 8VA



BZUČIAK 8 VA 12 V ~ 1M

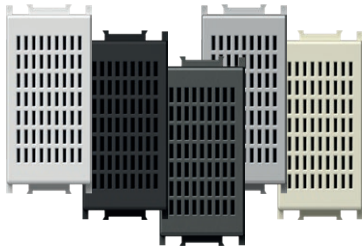

- EM91PW
- EM91SB
- EM91AT
- EM91ES
- EM91IW

- signálny bzučiak
- dĺžka zvukového signálu je rovnaká ako dĺžka stlačenia tlačidla
- napájacie napätie 12 V~ 50 Hz 8 VA

Buzzer 8VA 12V~1M

- signal buzzer
- the sound emission has the same lasting time as the control operation
- supply voltage 12V~ 50Hz 8VA



ZVONČEK 8 VA 230 V ~ 1M

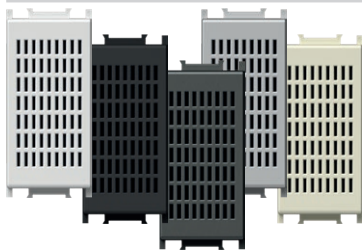

- EM92PW
- EM92SB
- EM92AT
- EM92ES
- EM92IW

- signálny zvonček
- dĺžka zvukového signálu je rovnaká ako dĺžka stlačenia tlačidla
- napájacie napätie 230 V~ 50 Hz 8 VA

Bell 8VA 230V~1M

- signal bell
- the sound emission has the same lasting time as the control operation
- supply voltage 230V~ 50Hz 8VA



ZVONČEK 8 VA 12V ~ 1M

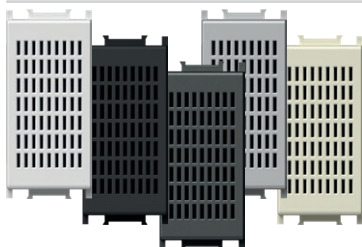

- EM93PW
- EM93SB
- EM93AT
- EM93ES
- EM93IW

- signálny zvonček
- dĺžka zvukového signálu je rovnaká ako dĺžka stlačenia tlačidla
- napájacie napätie 12 V~ 50 Hz 8 VA

Bell 8VA 12V~1M

- signal bell
- the sound emission has the same lasting time as the control operation
- supply voltage 12V~ 50Hz 8VA

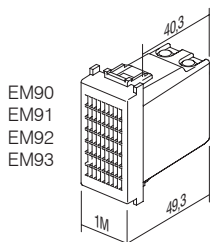

EM90
EM91
EM92
EM93

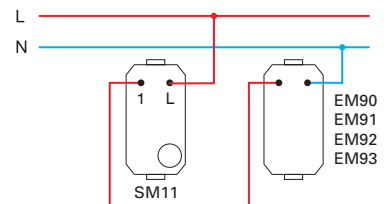



- EM95PW
- EM95SB
- EM95AT
- EM95ES
- EM95IW

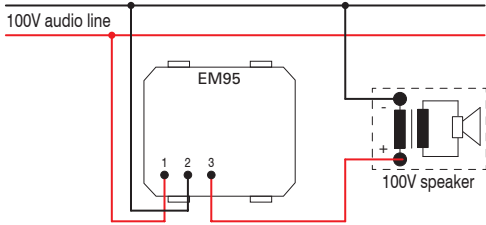

REGULÁTOR HLASITOSTI 100 V 35 W 2M

- regulátor hlasitosti (atenuátor) pre 100 V audio systémy
- menovitý výkon 35 W (max. 45 W), 6-stupňové ovládanie hlasitosti
- vhodný na inštaláciu do hlbokých krabic (najmenej 60 mm)
- nie je vhodný na inštaláciu do krabic hlbokých 45 mm a povrchových montážnych krabic CUBO IP20
- len na použitie v interiéri

VOLUME CONTROL 100V AUDIO LINE 35W 2M

- volume control (attenuator) for 100V audio systems
- power rating 35W (max. 45W), 6 steps volume control
- suitable for boxes min. 60 mm deep
- not suitable for installation in 45 mm deep boxes and surface mount boxes CUBO IP20
- for indoor use only

- EM96PW
- EM96SB
- EM96AT
- EM96ES
- EM96IW

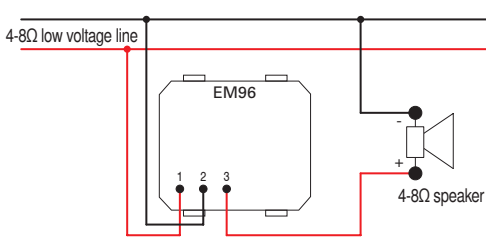

REGULÁTOR HLASITOSTI NÍZKONAPĚŤOVÝ 4-8 Ω 35 W 2M

- regulátor hlasitosti (atenuátor) pre nízkonapätové výstupy 4 – 8 Ω, 35 W
- menovitý výkon 35 W, 6-stupňové ovládanie hlasitosti
- vhodný na inštaláciu do hlbokých krabic (najmenej 60 mm)
- nie je vhodný na inštaláciu do krabic hlbokých 45 mm a povrchových montážnych krabic CUBO IP20
- len na použitie v interiéri

VOLUME CONTROL 4-8 Ω 35W 2M

- volume control (attenuator) for low voltage outputs 4-8 Ω, 35W
- power rating 35W, 6 steps volume control
- suitable for boxes min. 60 mm deep
- not suitable for installation in 45 mm deep boxes and surface mount boxes CUBO IP20
- for indoor use only

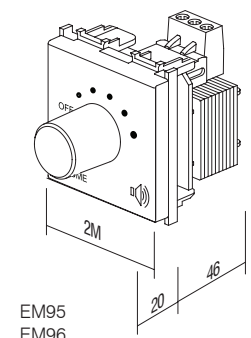



CM25

PW

OS

typ type	popis description	technické údaje technical data	veľkosť size	farba colour	voliteľné údaje 1 optional data 1
CM10	SÚPRAVA DVOCH ZÁSUVIEK SCHUKO SOCKET SET 2x SCHUKO	2P+E 16A 250V~ 4M	4M	<input type="checkbox"/> PW polárna biela polar white	<input type="checkbox"/> OL rámik LINE cover plate LINE
CM11	SÚPRAVA TROCH ZÁSUVIEK SCHUKO SOCKET SET 3x SCHUKO	2P+E 16A 250V~ 7M	7M	<input checked="" type="checkbox"/> SB čierna matná zamatová soft touch black	<input type="checkbox"/> OS rámik SOFT cover plate SOFT
CM15	SÚPRAVA SPOJOVACÍCH KÁBLOV LINK WIRE SET	3x1.5mm ²	1M	<input checked="" type="checkbox"/> AT antracit anthracite	
...	<input type="checkbox"/> ES strieborná matná elox silver	
...	<input type="checkbox"/> IW slonová kosť ivory white	

SADA ZÁSUVIEK 2x SCHUKO 2P+E 16A 250V~ 4M

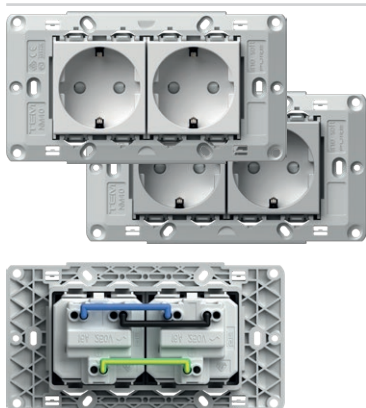

- CM10PW
- CM10ES

- súprava dvoch zásuviek schuko VM10 2P+E 16 A 250 V ~
- s namontovanou kabelážou CM16
- s montážnym rámom 4M bez skrutiek
- na upevnenie k montážnemu rámu použite skrutky CM17, CM18 alebo CM19
- skrutkové upevnenie vodičov 1,5 – 2,5 mm²
- v súlade s normou IEC-60884-1, CEE7

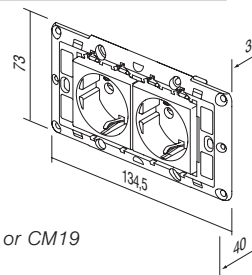

SOCKETS SET 2x SCHUKO 2P+E 16A 250V~ 4M

- socket set 2x schuko VM10 2P+E 16A 250V~
- prewired with link wires CM16
- with mounting frame 4M without screws
- for mounting frame fixing use screws CM17, CM18 or CM19
- screw contacts 1.5-2.5 mm²
- in accordance with IEC-60884-1, CEE7

SADA ZÁSUVIEK 3x SCHUKO 2P+E 16A 250V~ 7M

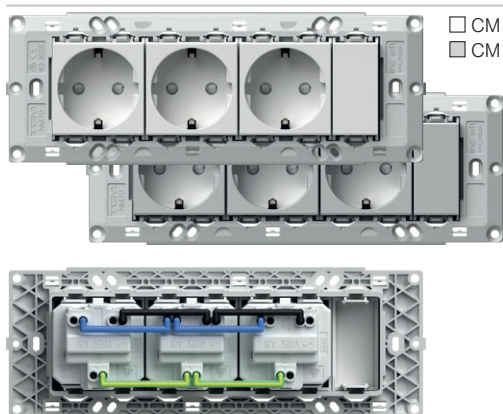

- CM11PW
- CM11ES

- súprava troch zásuviek schuko VM10 2P+E 16 A 250 V ~
- s namontovanou kabelážou CM16
- s montážnym rámom 7M bez skrutiek
- na upevnenie k montážnemu rámu použite skrutky CM17, CM18 alebo CM19
- skrutkové upevnenie vodičov 1,5 – 2,5 mm²
- v súlade s normou IEC-60884-1, CEE7

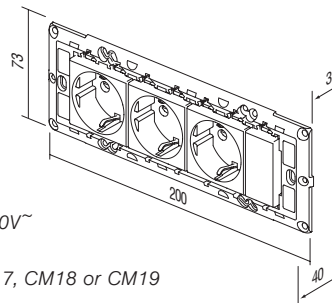

SOCKETS SET 3x SCHUKO 2P+E 16A 250V~ 7M

- socket set 3x schuko VM10 2P+E 16A 250V~
- prewired with link wires CM16
- with mounting frame 7M without screws
- for mounting frame fixing use screws CM17, CM18 or CM19
- screw contacts 1.5-2.5 mm²
- in accordance with IEC-60884-1, CEE7

SÚPRAVA PREPOJOVACÍCH PRVKOV 3 x 1,5 mm² 1M

CM15

- súprava spojovacích káblov na pripojenie dvoch prvkov o veľkosti 1M
- zahŕňa 10 čiernych, 10 modrých a 10 žltozelených drôtkov

LINK WIRE SET 3x1.5mm² 1M

- link wire set to connect two elements size 1M
- includes 10 black, 10 blue and 10 yellow/green wires

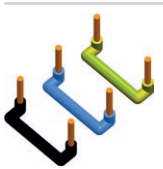
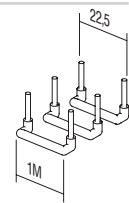
SÚPRAVA PREPOJOVACÍCH PRVKOV 3 x 2,5 mm² 2M

CM16

- súprava spojovacích káblov na pripojenie dvoch prvkov o veľkosti 2M
- zahŕňa 10 čiernych, 10 modrých a 10 žltozelených drôtkov

LINK WIRE SET 3x2.5mm² 2M

- link wire set to connect two elements size 2M
- includes 10 black, 10 blue and 10 yellow/green wires

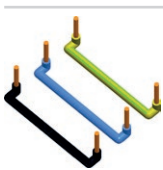
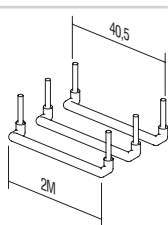
SÚPRAVA SKRUTIEK 3,5

CM17
CM18
CM19

- súprava skrutiek na upevnenie montážnych rámov NM30, NM32, NM40, NM41, NM70
- CM17 - l = 20 mm, 100 ks
- CM18 - l = 35 mm, 50 ks
- CM19 - l = 50 mm, 50 ks

SCREW SET 3,5

- screw set for fixing mounting frames NM30, NM32, NM40, NM41, NM70
- CM17 - l=20mm, 100pcs
- CM18 - l=35mm, 50pcs
- CM19 - l=50mm, 50pcs

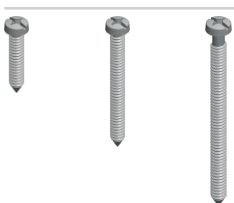
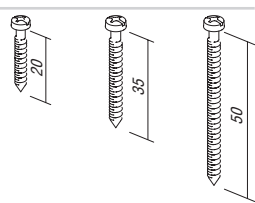

SADA IP 44 PRE SPÍNAČE 2M

CM22PW

- na použitie vo vlhkých priestoroch
- zabezpečuje krytie IP44 vhodné pre všetky spínače radu MODUL
- spínače a kryty tlačidiel nie sú súčasťou súpravy
- rámik SOFT 2M s popisným štítkom
- v súlade s normou IEC 60669-1

SET SWITCHES IP44 2M

- for usage in humid areas
- IP44 protection provides for all Modul switches
- switches and buttons are not part of the set
- SOFT 2M cover plate with inscription plate
- in accordance with IEC 60669-1



SADA IP44 PRE ZÁSUVKY 2M

CM23PW

- na použitie vo vlhkých priestoroch
- krytie IP44 možno dosiahnuť len v kombinácii s krytú zásuvkou (VM11, VM41)
- zásuvky nie sú súčasťou sady
- rámik SOFT 2M s popisným štítkom
- v súlade s normou IEC 60884-1

SET SOCKETS IP44 2M

- for usage in humid areas
- IP44 protection can be achieved only in combination with covered socket (VM11, VM41)
- sockets are not part of the set
- SOFT 2M cover plate with inscription plate
- in accordance with IEC 60884-1

SÚPRAVA SPÍNAČOV DO KÚPEĽNE 3x20A 250 V ~ 4M

CM25PWOL
 CM25IWOL
 CM25PWOS
 CM25IWOS

- súprava spínačov 3 x SM12 20 A 250 V ~ s montážnym rámom a dizajnovým rámkom
- skrutkové upevnenie vodičov 1,5 – 2,5 mm²
- v súlade s normou EN 60669-1
- možnosť upevnenia na už nainštalované krabice rozmerov upevnenia od 108 do 135 mm alebo na krabice veľkosti 4M
- výška dekoratívneho rámička 90 mm

SWITCH SET FOR BATHROOM 3x20A 250V~ 4M

- switch set 3xSM12 20A 250V~ with mounting frame and cover plate
- screw contacts 1.5-2.5mm²
- in accordance with EN 60669-1
- universal solution for renovation on boxes with fixing dimensions 108-135mm or boxes 4M size
- cover plate height 90mm

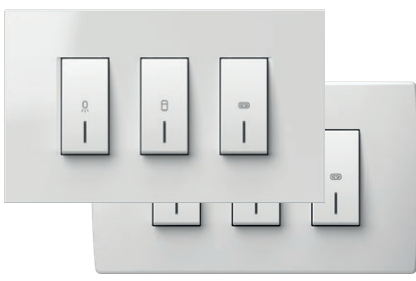
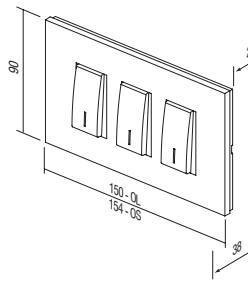

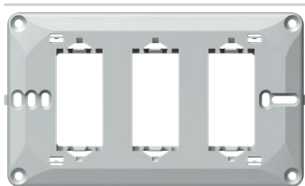
NM41

MONTÁŽNY RÁM PRE KÚPEĽŇOVÉ SADY 4M

- univerzálny montážny rám na kúpeľové súpravy so skrutkami
- univerzálne riešenie na montáž na obdĺžnikových krabiciach s rozmermi upevnenia 108 – 135 mm alebo na krabiciach o veľkosti 4M
- v súlade s normou EN 60669-1

MOUNTING FRAME BATHROOM SET 4M

- universal mounting frame for bathroom set with screws
- universal solution for mounting on rectangular boxes with fixing dimensions 108-135mm or boxes 4M size
- in accordance with EN 60669-1

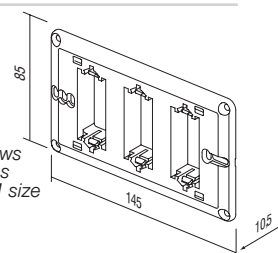

- OL41PW
- OL41NB
- OL41IW
- OL41ES
- OL41SG
- OL41IB

RÁMIK PRE KÚPEĽŇOVÚ SADU LINE

- dekoratívny rámik pre kúpeľňové súpravy LINE
- výška 90 mm
- v súlade s normou EN 60669-1

COVER PLATE LINE BATHROOM SET

- decorative cover plate bathroom set LINE
- height 90mm
- in accordance with EN 60669-1

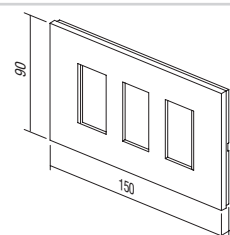

- OS41PW
- OS41NB
- OS41IW
- OS41ES
- OS41SG
- OS41SB
- OS41WE

RÁMIK PRE KÚPEĽŇOVÚ SADU SOFT

- dekoratívny rámik pre kúpeľňové súpravy SOFT
- výška 90 mm
- v súlade s normou EN 60669-1

COVER PLATE SOFT BATHROOM SET

- decorative cover plate bathroom set SOFT
- height 90mm
- in accordance with EN 60669-1

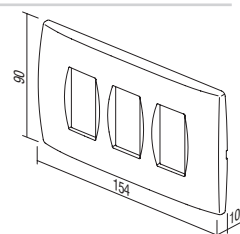

ANTIBAKTERIÁLNY PROGRAM MODUL

typ type	popis description	veľkosť size	farba colour	voliteľné údaje 1 optional data 1
TM11	KRYT TLAČIDLA BUTTON	1M	<input type="checkbox"/> AW antibakteriálna biela antibacterial white	 NT neutrálna neutral
TM21	VÝPLŇ BLANK	1M		
VM10	ZÁSUVKA SOCKET	2M		 IN indikátor indicator
.	.	.		
.	.	.		

ANTIBAKTERIÁLNY PROGRAM MODUL

- spínačov a zásuviek sa denne dotýka mnoho ľudí, takže predstavujú bežné miesto na množenie a šírenie baktérií
- striebro sa vďaka svojim prirodzeným antibakteriálnym vlastnostiam používa tri tisícročia ako bezpečný a účinný dezinfekčný prostriedok, pretože je úplne prírodné, zdravé a šetrné k životnému prostrediu
- špeciálna antibakteriálna prísada iónov striebra poskytuje dlhodobú, spoľahlivú a účinnú ochranu proti vzniku a šíreniu baktérií, vírusov, mikróbov a plesní
- antibakteriálna ochrana zabezpečuje ľuďom hygienu, čistotu a zdravie
- výborne sa hodí na použitie v prostrediach s prísnyimi hygienickými podmienkami (nemocnice, zdravotné strediská, farmaceutické zariadenia, domovy pre seniorov, sanatóriá, laboratória, reštaurácie, hotely, letiská, autobusové a železničné stanice, obchodné a nákupné priestory, verejné inštitúcie...)
- nezávislé laboratórne skúšky boli vykonané v súlade s najprísnejšími japonskými normami JIS Z 2801
- nízke náklady na zabezpečenie verejného zdravia
- dizajn a funkčnosť antibakteriálneho programu MODUL umožňuje jednoduché čistenie a údržbu
- antibakteriálne kryty tlačidiel, rámy a zásuvky sú kombinované s klasickými montážnymi rámmi a spínačmi
- výrobky sú označené na zadnej strane značkou AW (antibakteriálna biela)

ANTIBACTERIAL PROGRAM MODUL

- switches and sockets are daily touched by many people, so this is a common place for development and spread of bacteria
- thanks to its natural antibacterial characteristics silver has been used for three millennia as a safe and effective disinfectant, since it is completely natural, healthy and environmentally friendly
- special antibacterial silver ions additive provides long-term, reliable and effective protection against the development and spread of bacteria, viruses, microbes and fungi
- antibacterial protection ensures hygiene, cleanliness and health for people
- perfectly suitable for use in environments with strict hygiene conditions (hospitals, health centers, pharmaceutical facilities, homes for elderly, nursing homes, laboratories, restaurants, hotels, airports, bus and railway stations, business and shopping areas, public institutions ...)
- independent laboratory testings have been carried out in accordance with highest Japanese standards JIS Z 2801
- low cost for providing human health
- design and functionality of antibacterial program MODUL allow easy cleaning and maintenance
- antibacterial buttons, cover plates and sockets are combined with classic mounting frames and switches
- products are labelled on the back with AW (antibacterial white)

A N T I B A C T E R I A L P R O G R A M M O D U L

	□ TM11AW	KRYT TLAČIDLA 1M - vymeniteľný kryt tlačidla 1M - v súlade s normou EN 60669-1 - antibakteriálna ochrana v súlade s normou JIS Z 2801	
	□ TM11AWIN	KRYT TLAČIDLA S INDIKÁTOROM 1M - vymeniteľný kryt tlačidla s indikátorom 1M - v súlade s normou EN 60669-1 - antibakteriálna ochrana v súlade s normou JIS Z 2801	
	□ TM12AW	KRYT TLAČIDLA 2M - vymeniteľný kryt tlačidla 2M s úchytkou tlačidla - v súlade s normou EN 60669-1 - antibakteriálna ochrana v súlade s normou JIS Z 2801	
	□ TM12AWIN	KRYT TLAČIDLA S INDIKÁTOROM 2M - vymeniteľný kryt tlačidla s indikátorom 2M s úchytkou tlačidla - pri zmene vypínača alebo tlačidla z 1M na 2M veľkosť - v súlade s normou EN 60669-1 - antibakteriálna ochrana v súlade s normou JIS Z 2801	
	□ TM21AW	VÝPLŇ 1M - výplňový modul na zaplnenie prázdnych miest - v súlade s normou EN 60669-1 - antibakteriálna ochrana v súlade s normou JIS Z 2801	
	□ TM22AW	VÝPLŇ 2M - výplňový modul na zaplnenie prázdnych miest - v súlade s normou EN 60669-1 - antibakteriálna ochrana v súlade s normou JIS Z 2801	

BUTTON 1M

- replaceable button 1M
- in accordance with EN 60669-1
- antibacterial protection in accordance with JIS Z 2801

BUTTON 1M INDICATOR

- replaceable button 1M
- in accordance with EN 60669-1
- antibacterial protection in accordance with JIS Z 2801

BUTTON 2M

- replaceable button 2M with button carrier
- to upgrade switch or push button from size 1M to size 2M
- in accordance with EN 60669-1
- antibacterial protection in accordance with JIS Z 2801

BUTTON 2M INDICATOR

- replaceable button 2M with button carrier
- to upgrade switch or push button from size 1M to size 2M
- in accordance with EN 60669-1
- antibacterial protection in accordance with JIS Z 2801

BLANK 1M

- blank modul to fill up empty spaces
- in accordance with EN 60669-1
- antibacterial protection in accordance with JIS Z 2801

BLANK 2M

- blank modul to fill up empty spaces
- in accordance with EN 60669-1
- antibacterial protection in accordance with JIS Z 2801



□ VM10AW

ZÁSUVKA SCHUKO + KS 2P+E 16 A 250 V ~ 2M

- 2P+E schuko
- 16 A 250 V ~, typ VM10
- v súlade s normou IEC 60884-1, CEE7
- skrutkové upevnenie vodičov 1,5 – 2,5 mm²
- zabudovaná ochrana pred dotykom s kontaktmi pod napätím
- antibakteriálna ochrana v súlade s normou JIS Z 2801

SOCKET SCHUKO+KS 2P+E 16A 250V~ 2M

- 2P+E schuko
- 16A 250V~, type VM10
- in accordance with IEC 60884-1, CEE7
- screw contacts 1.5-2.5 mm²
- shuttered live contacts
- antibacterial protection in accordance with JIS Z 2801



□□ VM11AW

ZÁSUVKA SCHUKO + KS + KRYT 2P+E 16 A 250 V ~ 2M

- 2P + E schuko + kryt
- 16 A 250 V ~, typ VM11
- v súlade s normou IEC 60884-1, CEE7
- skrutkové upevnenie vodičov 1,5 – 2,5 mm²
- zabudovaná ochrana pred dotykom s kontaktmi pod napätím
- antibakteriálna ochrana v súlade s normou JIS Z 2801

SOCKET SCHUKO+KS+COVER

- 2P+E 16A 250V~ 2M
- 2P+E schuko+cover
- 16A 250V~, type VM11
- in accordance with IEC 60884-1, CEE7
- screw contacts 1.5-2.5 mm²
- shuttered live contacts
- antibacterial protection in accordance with JIS Z 2801



□ VM20AW

ZÁSUVKA EURO + KS 2P 10 A 250 V ~ 1M

- 2P Euro
- 10 A 250 V ~, typ VM20
- v súlade s normou IEC 60884-1, CEE7
- skrutkové upevnenie vodičov 1,5 – 2,5 mm²
- zabudovaná ochrana pred dotykom s kontaktmi pod napätím
- antibakteriálna ochrana v súlade s normou JIS Z 2801

SOCKET EURO+KS 2P 10A 250V~ 1M

- 2P Euro
- 10A 250V~, type VM20
- in accordance with IEC 60884-1, CEE7
- screw contacts 1.5-2.5 mm²
- shuttered live contacts
- antibacterial protection in accordance with JIS Z 2801



□ KM11AW

ZÁSUVKA TV KONCOVÁ 1 dB 1M

- TV koncová
- frekvenčné pásmo 5 ÷ 2 400 MHz
- útlm < 1 dB
- v súlade s normou EN 50083-1
- skrutkové upevnenie vodičov
- antibakteriálna ochrana v súlade s normou JIS Z 2801

SOCKET TV END-LINE 1dB 1M

- TV end-line
- frequency range 5÷2400 MHz
- reduction < 1 dB
- in accordance with EN 50083-1
- screw contacts
- antibacterial protection in accordance with JIS Z 2801

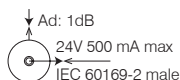

□ KM35AW

ADAPTÉR KS 1M

- KS keystone štandard upevnenia
- AMP, Avaya, Brandrex, FMT, Mfico, Tyco, ...
- komunikačný modul nie je súčasťou dodávky
- antibakteriálna ochrana v súlade s normou JIS Z 2801

ADAPTER KS 1M

- KS keystone fixing standard
- AMP, Avaya, Brandrex, FMT, Mfico, Tyco, ...
- communication module not included
- antibacterial protection in accordance with JIS Z 2801



A N T I B A C T E R I A L P R O G R A M M O D U L



OS20AW

RÁMIK SOFT 2M

- dekoračný rámik SOFT 2M
- v súlade s normou EN 60669-1
- antibakteriálna ochrana v súlade s normou JIS Z 2801

COVER PLATE SOFT 2M

- decorative cover plate SOFT 2M
- in accordance with EN 60669-1
- antibacterial protection in accordance with JIS Z 2801



OS24AW

RÁMIK SOFT 2 x 2M

- dekoračný rámik SOFT 2 x 2M
- horizontálna alebo vertikálna montáž
- v súlade s normou EN 60669-1
- antibakteriálna ochrana v súlade s normou JIS Z 2801

COVER PLATE SOFT 2x2M

- decorative cover plate SOFT 2x2M
- horizontal or vertical mounting
- in accordance with EN 60669-1
- antibacterial protection in accordance with JIS Z 2801

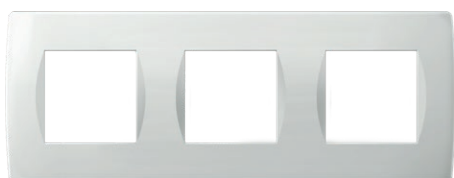

OS26AW

RÁMIK SOFT 3 x 2M

- dekoračný rámik SOFT 3 x 2M
- horizontálna alebo vertikálna montáž
- v súlade s normou EN 60669-1
- antibakteriálna ochrana v súlade s normou JIS Z 2801

COVER PLATE SOFT 3x2M

- decorative cover plate SOFT 3x2M
- horizontal or vertical mounting
- in accordance with EN 60669-1
- antibacterial protection in accordance with JIS Z 2801

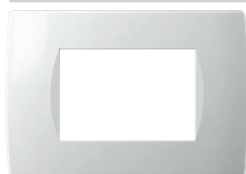

OS30AW

RÁMIK SOFT 3M

- dekoračný rámik SOFT 3M
- antibakteriálna ochrana v súlade s normou JIS Z 2801
- v súlade s normou EN 60669-1

COVER PLATE SOFT 3M

- decorative cover plate SOFT 3M
- in accordance with EN 60669-1
- antibacterial protection in accordance with JIS Z 2801

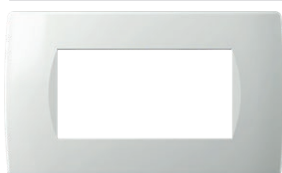

OS40AW

RÁMIK SOFT 4M

- dekoračný rámik SOFT 4M
- v súlade s normou EN 60669-1
- antibakteriálna ochrana v súlade s normou JIS Z 2801

COVER PLATE SOFT 4M

- decorative cover plate SOFT 4M
- in accordance with EN 60669-1
- antibacterial protection in accordance with JIS Z 2801

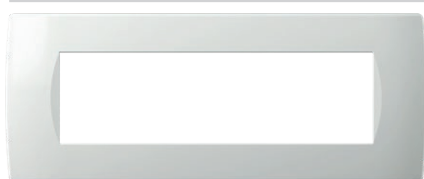

OS70AW

RÁMIK SOFT 7M

- dekoračný rámik SOFT 7M
- v súlade s normou EN 60669-1
- antibakteriálna ochrana v súlade s normou JIS Z 2801

COVER PLATE SOFT 7M

- decorative cover plate SOFT 7M
- in accordance with EN 60669-1
- antibacterial protection in accordance with JIS Z 2801

drevo
wood

WB bambus
bamboo



WW orech
walnut



WM javor
maple



WE wenge
wenge



Príroda je jedinečná a vzácna, rovnako ako naše dekoratívne (krycie) rámy, z ktorých ani jeden nie je rovnaký ako druhý.
Sťažnosti na rozdielny vzhľad a odlišnosť našich drevených dekoratívnych (krycích) rámov nemôžeme brať do úvahy.

Nature is unique and precious, as our decorative cover plates where no two are the same.
Complaints about wooden decorative cover plate's diverse appearance and differentiation cannot be considered.

COVER PLATES PURE OP

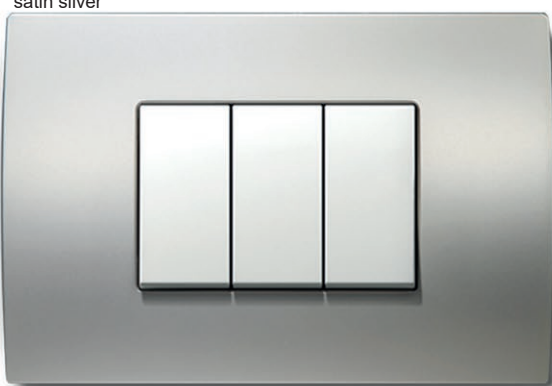
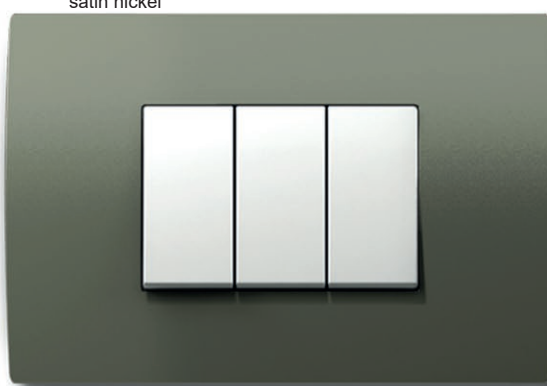
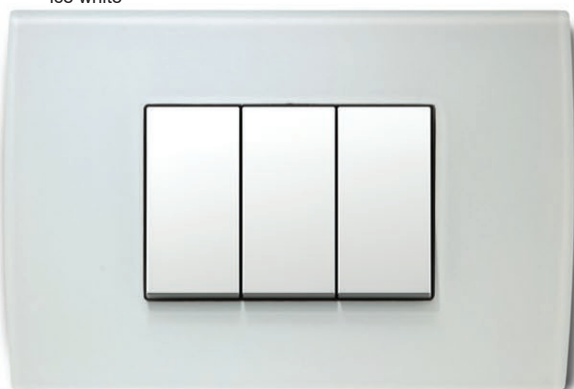
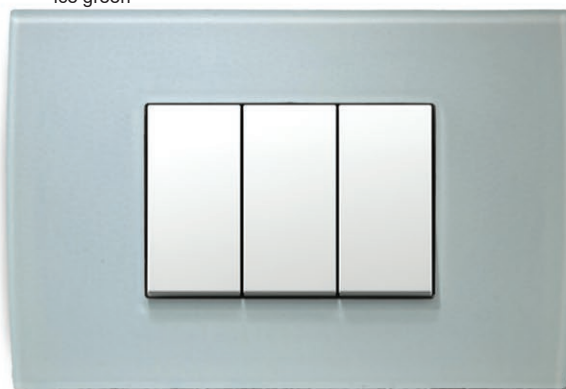
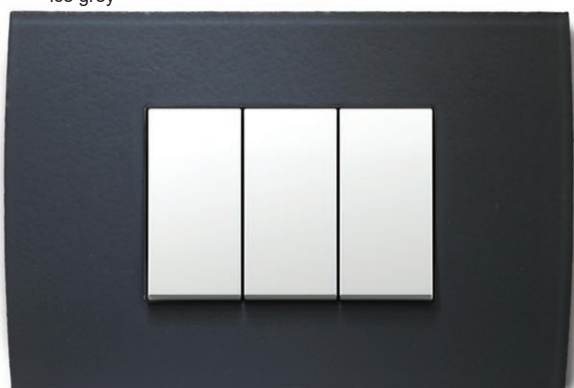
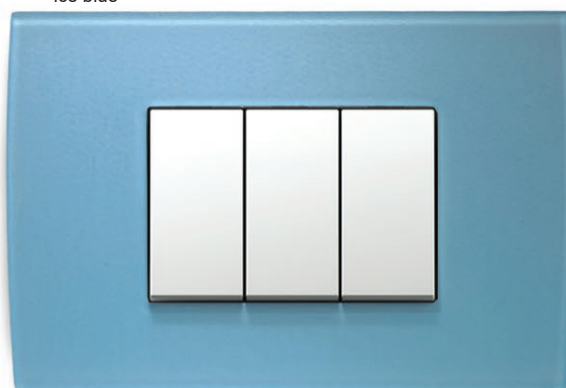
kov
metalMH kovaná oceľ
hammered steelME zoxidované železo
etched ironMS satinované striebro
satin silverMN satinovaný nikel
satin nickelsklo
glassGW ľadová biela
ice whiteGG ľadová zelená
ice greenGY ľadová sivá
ice greyGB ľadová modrá
ice blue



typ type	popis description	veľkosť size	farba colour
OP13	RÁMIK PURE COVER PLATE PURE	1/3M	MH kovaná oceľ hammered steel
OP20	RÁMIK PURE COVER PLATE PURE	2M	ME zoxidované železo etched iron
OP23	RÁMIK PURE COVER PLATE PURE	2/3M	MS satínované striebro satin silver
.	.	.	MN satínovaný nikel satin nickel
.	.	.	WB bambus bamboo
.	.	.	WW orech walnut
.	.	.	WM javor maple
.	.	.	WE wenge wenge
.	.	.	GW ľadová biela ice white
.	.	.	GG ľadová zelená ice green
.	.	.	GY ľadová sivá ice grey
.	.	.	GB ľadová modrá ice blue



MH	OP20MH	WB	OP20WB
ME	OP20ME	WW	OP20WW
MS	OP20MS	WM	OP20WM
MN	OP20MN	WE	OP20WE
		GW	OP20GW
		GG	OP20GG
		GY	OP20GY
		GB	OP20GB

RÁMIK PURE 2M

- dekoratívny rámik PURE 2M
- v súlade s normou EN 60669-1
- len v kombinácii s montážnym rámom NM24 alebo NM25

COVER PLATE PURE 2M

- decorative cover plate PURE 2M
- in accordance with EN 60669-1
- only in combination with mounting frames NM24 or NM25

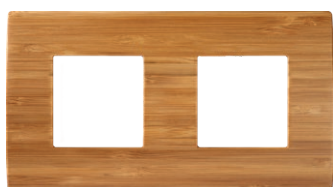

MH	OP24MH	WB	OP24WB
ME	OP24ME	WW	OP24WW
MS	OP24MS	WM	OP24WM
MN	OP24MN	WE	OP24WE
		GW	OP24GW
		GG	OP24GG
		GY	OP24GY
		GB	OP24GB

RÁMIK PURE 2x2M

- dekoratívny rámik PURE 2x2M
- horizontálna alebo vertikálna montáž
- v súlade s normou EN 60669-1
- len v kombinácii s montážnym rámom NM24 alebo NM25

COVER PLATE PURE 2x2M

- decorative cover plate PURE 2x2M
- horizontal or vertical mounting
- in accordance with EN 60669-1
- only in combination with mounting frames NM24 or NM25



MH	OP26MH	WB	OP26WB
ME	OP26ME	WW	OP26WW
MS	OP26MS	WM	OP26WM
MN	OP26MN	WE	OP26WE
		GW	OP26GW
		GG	OP26GG
		GY	OP26GY
		GB	OP26GB

RÁMIK PURE 3x2M

- dekoratívny rámik PURE 3x2M
- horizontálna alebo vertikálna montáž
- v súlade s normou EN 60669-1
- len v kombinácii s montážnym rámom NM24 alebo NM25

COVER PLATE PURE 3x2M

- decorative cover plate PURE 3x2M
- horizontal or vertical mounting
- in accordance with EN 60669-1
- only in combination with mounting frames NM24 or NM25



MH	OP28MH	WB	OP28WB
ME	OP28ME	WW	OP28WW
MS	OP28MS	WM	OP28WM
MN	OP28MN	WE	OP28WE
		GW	OP28GW
		GG	OP28GG
		GY	OP28GY
		GB	OP28GB

RÁMIK PURE 4x2M

- dekoratívny rámik PURE 4x2M
- horizontálna alebo vertikálna montáž
- v súlade s normou EN 60669-1
- len v kombinácii s montážnym rámom NM24 alebo NM25

COVER PLATE PURE 4x2M

- decorative cover plate PURE 4x2M
- horizontal or vertical mounting
- in accordance with EN 60669-1
- only in combination with mounting frames NM24 or NM25

COVER PLATES PURE OP



	OP30MH		OP30WB
	OP30ME		OP30WW
	OP30MS		OP30WM
	OP30MN		OP30WE
			OP30GW
			OP30GG
			OP30GY
			OP30GB

RÁMIK PURE 3M

- dekoračný rámik PURE 3M
- v súlade s normou EN 60669-1

COVER PLATE PURE 3M

- decorative cover plate PURE 3M
- in accordance with EN 60669-1



	OP40MH		OP40WB
	OP40ME		OP40WW
	OP40MS		OP40WM
	OP40MN		OP40WE
			OP40GW
			OP40GG
			OP40GY
			OP40GB

RÁMIK PURE 4M

- dekoračný rámik PURE 4M
- v súlade s normou EN 60669-1

COVER PLATE PURE 4M

- decorative cover plate PURE 4M
- in accordance with EN 60669-1



	OP70MH		OP70WB
	OP70ME		OP70WW
	OP70MS		OP70WM
	OP70MN		OP70WE
			OP70GW
			OP70GG
			OP70GY
			OP70GB

RÁMIK PURE 7M

- dekoračný rámik PURE 7M
- v súlade s normou EN 60669-1

COVER PLATE PURE 7M

- decorative cover plate PURE 7M
- in accordance with EN 60669-1



	OP13MH		OP13WB
	OP13ME		OP13WW
	OP13MS		OP13WM
	OP13MN		OP13WE
			OP13GW
			OP13GG
			OP13GY
			OP13GB

RÁMIK PURE 1/3M

- dekoračný rámik PURE 1/3M
- v súlade s normou EN 60669-1

COVER PLATE PURE 1/3M

- decorative cover plate PURE 1/3M
- in accordance with EN 60669-1



	OP23MH		OP23WB
	OP23ME		OP23WW
	OP23MS		OP23WM
	OP23MN		OP23WE
			OP23GW
			OP23GG
			OP23GY
			OP23GB

RÁMIK PURE 2/3M

- dekoračný rámik PURE 2/3M
- v súlade s normou EN 60669-1

COVER PLATE PURE 2/3M

- decorative cover plate PURE 2/3M
- in accordance with EN 60669-1

základná
basic

PW polárna biela
polar white

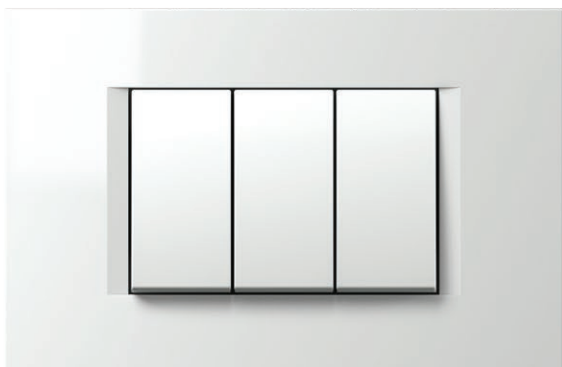

IW slonová kosť
ivory white

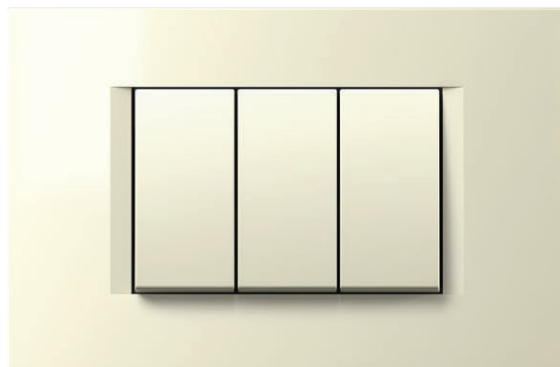

ES strieborná matná
elox silver



SB čierna matná zamatová
soft touch black

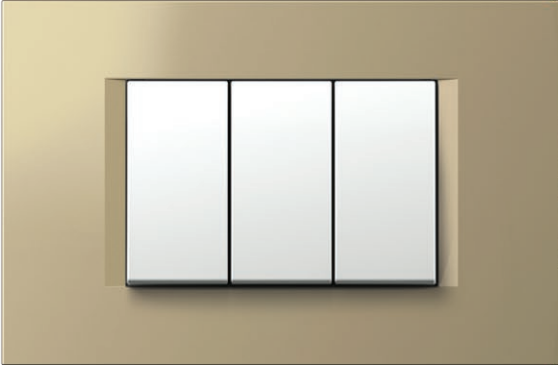
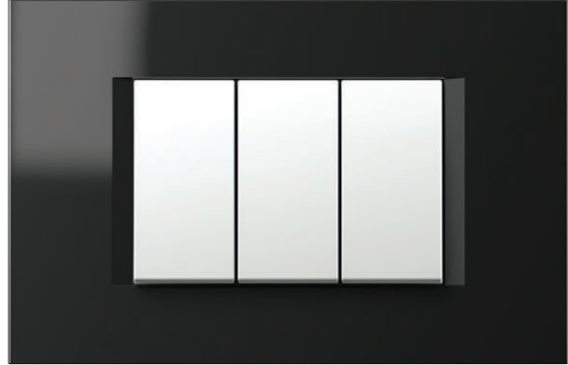
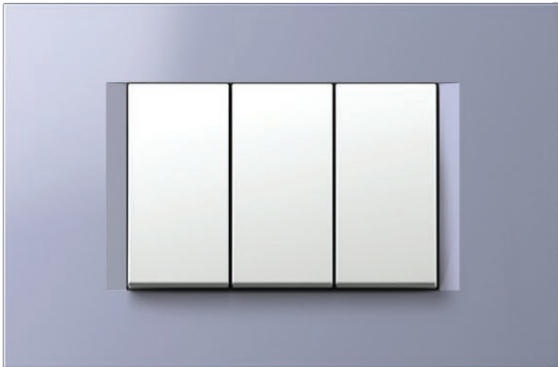
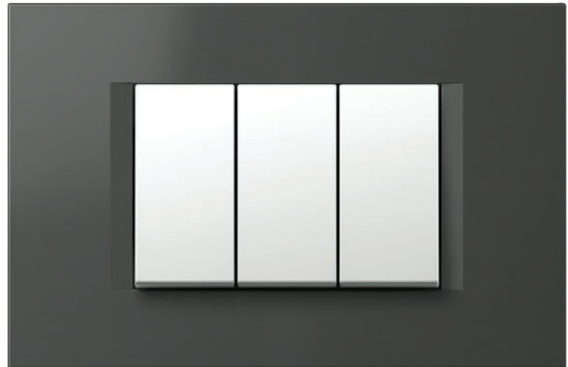
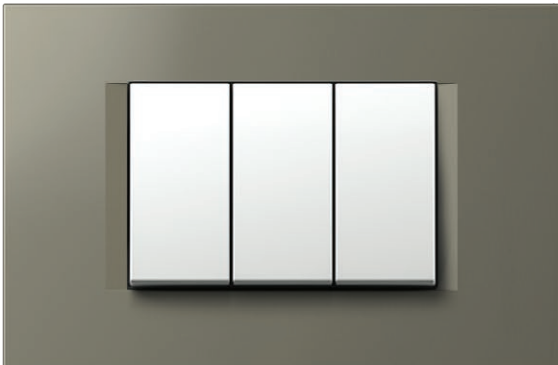

C O V E R P L A T E S L I N E O L

ozdobná
decorSG piesková zlatá
sand goldNB čierna lesklá
night blackIB impulzná modrá
impulse blueAT antracit
anthraciteTI titán
titaniumSW biela mramor
stone white

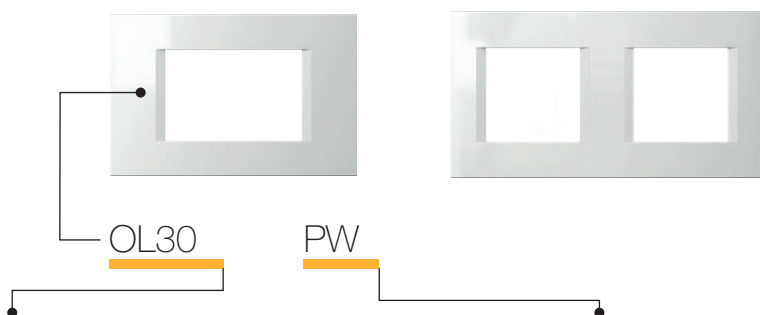

typ type	popis description	veľkosť size	farba colour																		
OL10	RÁMIK LINE COVER PLATE LINE	1/2M	<table border="0"> <tr> <td></td> <td>PW</td> <td>polárna biela polar white</td> <td></td> <td>SG</td> <td>piesková zlatá sand gold</td> <td></td> <td>AT</td> <td>antracit anthracite</td> </tr> </table>		PW	polárna biela polar white		SG	piesková zlatá sand gold		AT	antracit anthracite									
	PW	polárna biela polar white		SG	piesková zlatá sand gold		AT	antracit anthracite													
OL13	RÁMIK LINE COVER PLATE LINE	1/3M	<table border="0"> <tr> <td></td> <td>IW</td> <td>slonová kosť ivory white</td> <td></td> <td>NB</td> <td>čierna lesklá night black</td> <td></td> <td>TI</td> <td>titán titanium</td> </tr> </table>		IW	slonová kosť ivory white		NB	čierna lesklá night black		TI	titán titanium									
	IW	slonová kosť ivory white		NB	čierna lesklá night black		TI	titán titanium													
OL20	RÁMIK LINE COVER PLATE LINE	2M	<table border="0"> <tr> <td></td> <td>ES</td> <td>strieborná matná elox silver</td> <td></td> <td>IB</td> <td>impulzná modrá impulse blue</td> <td></td> <td>SW</td> <td>biela mramor stone white</td> </tr> <tr> <td></td> <td>SB</td> <td>čierna matná zamatová soft touch black</td> <td></td> <td></td> <td></td> <td></td> <td></td> <td></td> </tr> </table>		ES	strieborná matná elox silver		IB	impulzná modrá impulse blue		SW	biela mramor stone white		SB	čierna matná zamatová soft touch black						
	ES	strieborná matná elox silver		IB	impulzná modrá impulse blue		SW	biela mramor stone white													
	SB	čierna matná zamatová soft touch black																			



RÁMIK LINE 2M

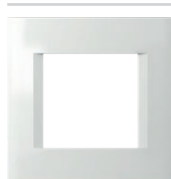

	OL20PW		OL20SG
	OL20IW		OL20NB
	OL20ES		OL20IB
	OL20SB		OL20AT
			OL20TI
			OL20SW

- dekoračný rámik LINE 2M
- v súlade s normou EN 60669-1
COVER PLATE LINE 2M
- decorative cover plate LINE 2M
- in accordance with EN 60669-1

RÁMIK LINE 2x2M

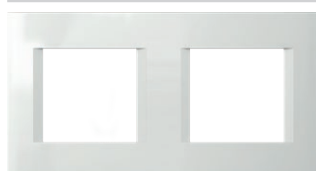

	OL24PW		OL24SG
	OL24IW		OL24NB
	OL24ES		OL24IB
	OL24SB		OL24AT
			OL24TI
			OL24SW

- dekoračný rámik LINE 2 x 2M
- horizontálna alebo vertikálna montáž
- v súlade s normou EN 60669-1
COVER PLATE LINE 2x2M
- decorative cover plate LINE 2x2M
- horizontal or vertical mounting
- in accordance with EN 60669-1

RÁMIK LINE 3x2M

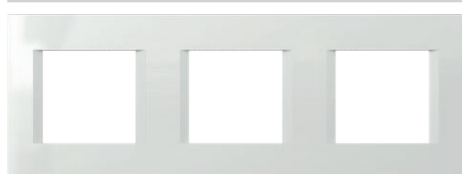

	OL26PW		OL26SG
	OL26IW		OL26NB
	OL26ES		OL26IB
	OL26SB		OL26AT
			OL26TI
			OL26SW

- dekoračný rámik LINE 3 x 2M
- horizontálna alebo vertikálna montáž
- v súlade s normou EN 60669-1
COVER PLATE LINE 3x2M
- decorative cover plate LINE 3x2M
- horizontal or vertical mounting
- in accordance with EN 60669-1

RÁMIK LINE 4x2M



	OL28PW		OL28SG
	OL28IW		OL28NB
	OL28ES		OL28IB
	OL28SB		OL28AT
			OL28TI
			OL28SW

- dekoračný rámik LINE 4 x 2M
- horizontálna alebo vertikálna montáž
- v súlade s normou EN 60669-1
COVER PLATE LINE 4x2M
- decorative cover plate LINE 4x2M
- horizontal or vertical mounting
- in accordance with EN 60669-1

RÁMIK LINE 5x2M

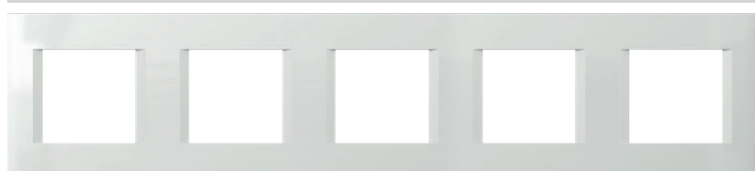









	OL29PW
	OL29IW
	OL29ES
	OL29SB
	OL29AT
	OL29TI

- dekoračný rámik LINE 5 x 2M
- horizontálna alebo vertikálna montáž
- v súlade s normou EN 60669-1
COVER PLATE LINE 5x2M
- decorative cover plate LINE 5x2M
- horizontal or vertical mounting
- in accordance with EN 60669-1

COVER PLATES LINE OL











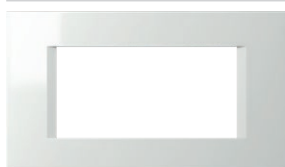

 OL30PW	 OL30SG
 OL30IW	 OL30NB
 OL30ES	 OL30IB
 OL30SB	 OL30AT
	 OL30TI
	 OL30SW

RÁMIK LINE 3M

- dekoračný rámik LINE 3M
- v súlade s normou EN 60669-1

COVER PLATE LINE 3M
- decorative cover plate LINE 3M
- in accordance with EN 60669-1











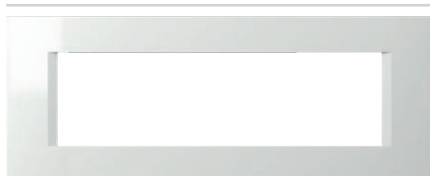

 OL40PW	 OL40SG
 OL40IW	 OL40NB
 OL40ES	 OL40IB
 OL40SB	 OL40AT
	 OL40TI
	 OL40SW

RÁMIK LINE 4M

- dekoračný rámik LINE 4M
- v súlade s normou EN 60669-1

COVER PLATE LINE 4M
- decorative cover plate LINE 4M
- in accordance with EN 60669-1













 OL70PW	 OL70SG
 OL70IW	 OL70NB
 OL70ES	 OL70IB
 OL70SB	 OL70AT
	 OL70TI
	 OL70SW

RÁMIK LINE 7M

- dekoračný rámik LINE 7M
- v súlade s normou EN 60669-1

COVER PLATE LINE 7M
- decorative cover plate LINE 7M
- in accordance with EN 60669-1









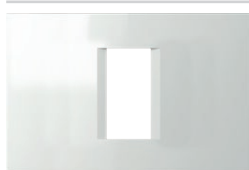

 OL10PW	 OL10SG
 OL10IW	 OL10NB
 OL10ES	 OL10IB
 OL10SB	 OL10AT
	 OL10TI
	 OL10SW

RÁMIK LINE 1/2M

- dekoračný rámik LINE 1/2M
- v súlade s normou EN 60669-1

COVER PLATE LINE 1/2M
- decorative cover plate LINE 1/2M
- in accordance with EN 60669-1













 OL13PW	 OL13SG
 OL13IW	 OL13NB
 OL13ES	 OL13IB
 OL13SB	 OL13AT
	 OL13TI
	 OL13SW

RÁMIK LINE 1/3M

- dekoračný rámik LINE 1/3M
- v súlade s normou EN 60669-1

COVER PLATE LINE 1/3M
- decorative cover plate LINE 1/3M
- in accordance with EN 60669-1



 OL23PW	 OL23SG
 OL23IW	 OL23NB
 OL23ES	 OL23IB
 OL23SB	 OL23AT
	 OL23TI
	 OL23SW

RÁMIK LINE 2/3M

- dekoračný rámik LINE 2/3M
- v súlade s normou EN 60669-1

COVER PLATE LINE 2/3M
- decorative cover plate LINE 2/3M
- in accordance with EN 60669-1

základná
basic

PW polárna biela
polar white

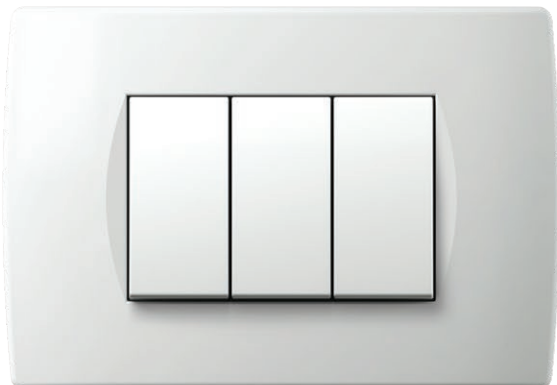

IW slonová kosť
ivory white

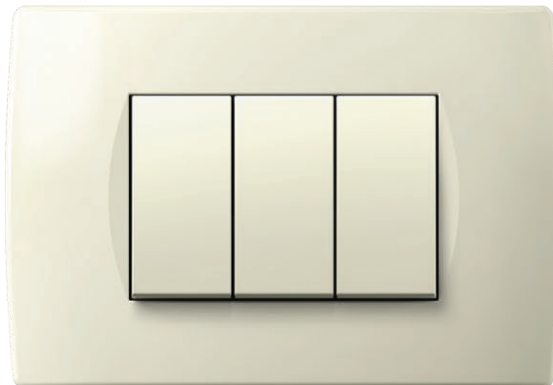

ES strieborná matná
elox silver

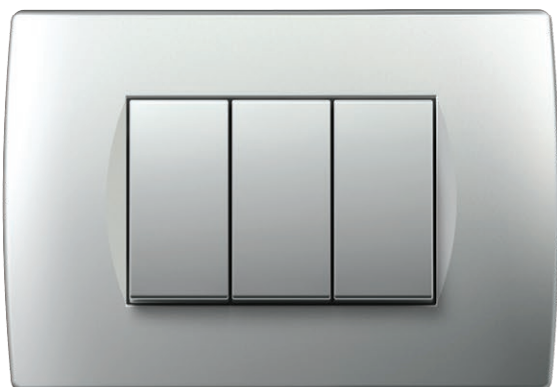

SB čierna matná zamatová
soft touch black

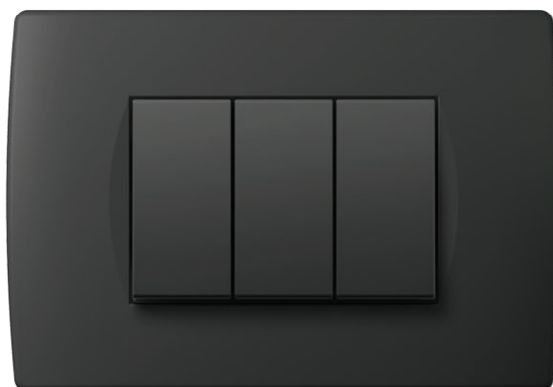

C O V E R P L A T E S S O F T O S

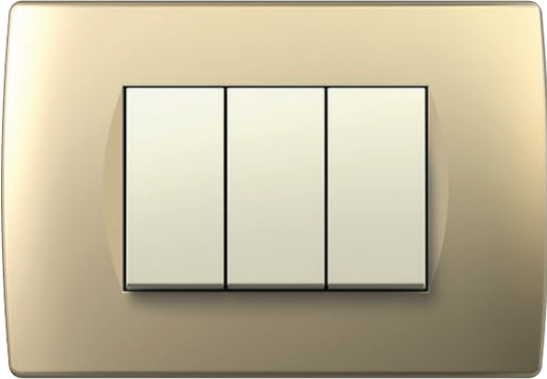
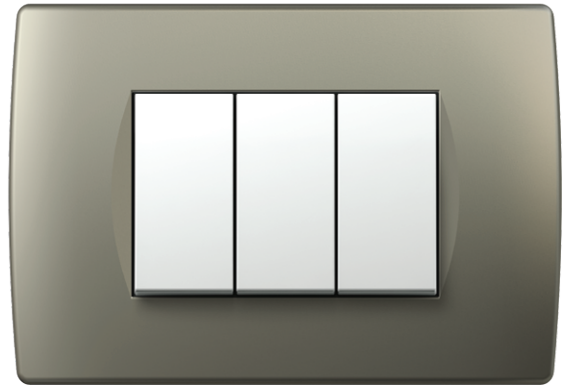
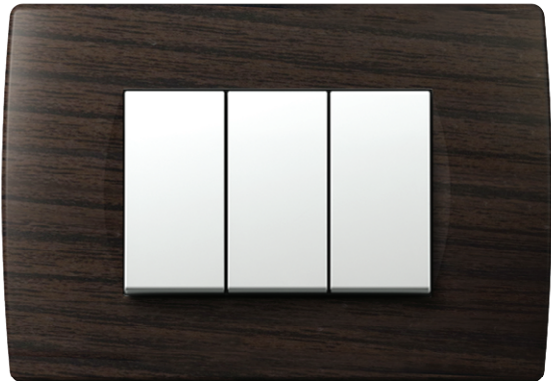
ozdobná
decorSG piesková zlatá
sand goldNB čierna lesklá
night blackAT antracit
anthraciteTI titán
titaniumWE wenge
wengeWW orech
walnut

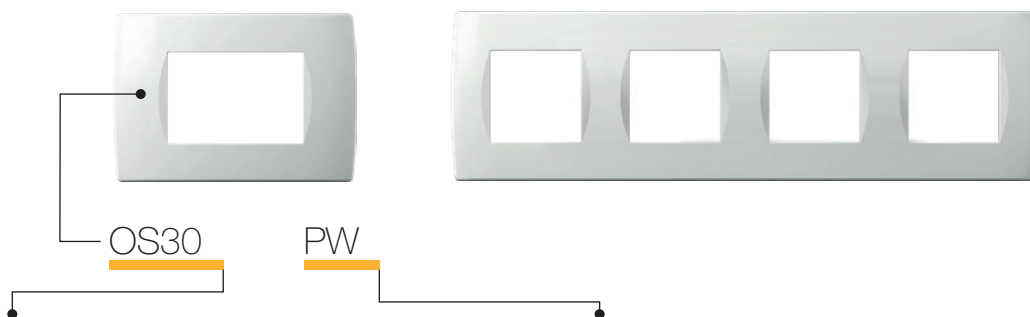

typ type	popis description	veľkosť size	farba colour																		
OS10	RÁMIK SOFT COVER PLATE SOFT	1/2M	<table border="0"> <tr> <td></td> <td>PW</td> <td>polárna biela polar white</td> <td></td> <td>SG</td> <td>piesková zlatá sand gold</td> <td></td> <td>WW</td> <td>orech walnut</td> </tr> </table>		PW	polárna biela polar white		SG	piesková zlatá sand gold		WW	orech walnut									
	PW	polárna biela polar white		SG	piesková zlatá sand gold		WW	orech walnut													
OS13	RÁMIK SOFT COVER PLATE SOFT	1/3M	<table border="0"> <tr> <td></td> <td>IW</td> <td>slonová kosť ivory white</td> <td></td> <td>NB</td> <td>čierna lesklá night black</td> <td></td> <td>WE</td> <td>wenge wenge</td> </tr> </table>		IW	slonová kosť ivory white		NB	čierna lesklá night black		WE	wenge wenge									
	IW	slonová kosť ivory white		NB	čierna lesklá night black		WE	wenge wenge													
OS20	RÁMIK SOFT COVER PLATE SOFT	2M	<table border="0"> <tr> <td></td> <td>ES</td> <td>strieborná matná elox silver</td> <td></td> <td>AT</td> <td>antracit anthracite</td> <td></td> <td>TI</td> <td>titán titanium</td> </tr> <tr> <td></td> <td>SB</td> <td>čierna matná soft touch black</td> <td></td> <td>TI</td> <td>titán titanium</td> <td></td> <td></td> <td></td> </tr> </table>		ES	strieborná matná elox silver		AT	antracit anthracite		TI	titán titanium		SB	čierna matná soft touch black		TI	titán titanium			
	ES	strieborná matná elox silver		AT	antracit anthracite		TI	titán titanium													
	SB	čierna matná soft touch black		TI	titán titanium																



	OS20PW		OS20SG
	OS20IW		OS20NB
	OS20ES		OS20AT
	OS20SB		OS20TI
			OS20WW
			OS20WE

RÁMIK SOFT 2M

- dekoratívny rámik SOFT 2M
- v súlade s normou EN 60669-1

COVER PLATE SOFT 2M

- decorative cover plate SOFT 2M
- in accordance with EN 60669-1



	OS24PW		OS24SG
	OS24IW		OS24NB
	OS24ES		OS24AT
	OS24SB		OS24TI
			OS24WW
			OS24WE

RÁMIK SOFT 2 x 2M

- dekoratívny rámik SOFT 2 x 2M
- horizontálna alebo vertikálna montáž
- v súlade s normou EN 60669-1

COVER PLATE SOFT 2x2M

- decorative cover plate SOFT 2x2M
- horizontal or vertical mounting
- in accordance with EN 60669-1

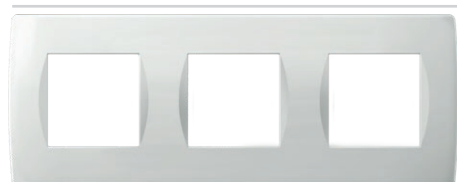

	OS26PW		OS26SG
	OS26IW		OS26NB
	OS26ES		OS26AT
	OS26SB		OS26TI
			OS26WW
			OS26WE

RÁMIK SOFT 3 x 2M

- dekoratívny rámik SOFT 3 x 2M
- horizontálna alebo vertikálna montáž
- v súlade s normou EN 60669-1

COVER PLATE SOFT 3x2M

- decorative cover plate SOFT 3x2M
- horizontal or vertical mounting
- in accordance with EN 60669-1



	OS28PW		OS28SG
	OS28IW		OS28NB
	OS28ES		OS28AT
	OS28SB		OS28TI
			OS28WW
			OS28WE

RÁMIK SOFT 4 x 2M

- dekoratívny rámik SOFT 4 x 2M
- horizontálna alebo vertikálna montáž
- v súlade s normou EN 60669-1

COVER PLATE SOFT 4x2M

- decorative cover plate SOFT 4x2M
- horizontal or vertical mounting
- in accordance with EN 60669-1

COVER PLATES SOFT OS

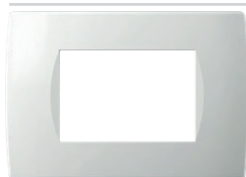

 OS30PW	 OS30SG
 OS30IW	 OS30NB
 OS30ES	 OS30AT
 OS30SB	 OS30TI
	 OS30WW
	 OS30WE









RÁMIK SOFT 3M

- dekoračný rámik SOFT 3M
- v súlade s normou EN 60669-1

COVER PLATE SOFT 3M

- decorative cover plate SOFT 3M
- in accordance with EN 60669-1



 OS40PW	 OS40SG
 OS40IW	 OS40NB
 OS40ES	 OS40AT
 OS40SB	 OS40TI
	 OS40WW
	 OS40WE









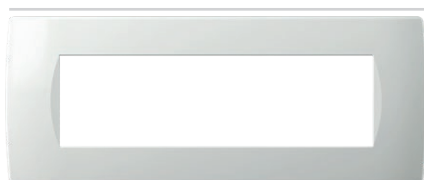

RÁMIK SOFT 4M

- dekoračný rámik SOFT 4M
- v súlade s normou EN 60669-1

COVER PLATE SOFT 4M

- decorative cover plate SOFT 4M
- in accordance with EN 60669-1



 OS70PW	 OS70SG
 OS70IW	 OS70NB
 OS70ES	 OS70AT
 OS70SB	 OS70TI
	 OS70WW
	 OS70WE







RÁMIK SOFT 7M

- dekoračný rámik SOFT 7M
- v súlade s normou EN 60669-1

COVER PLATE SOFT 7M

- decorative cover plate SOFT 7M
- in accordance with EN 60669-1



 OS72PW	 OS72AT
 OS72IW	 OS72TI
 OS72ES	
 OS72SB	

RÁMIK SOFT 2x7M

- dekoračný rámik SOFT 2 x 7M
s popisnou tabuľou
- v súlade s normou EN 60669-1

COVER PLATE SOFT 2x7M

- decorative cover plate SOFT 2x7M
with inscription plate
- in accordance with EN 60669-1



 OS10PW	 OS10SG
 OS10IW	 OS10NB
 OS10ES	 OS10AT
 OS10SB	 OS10TI
	 OS10WW
	 OS10WE









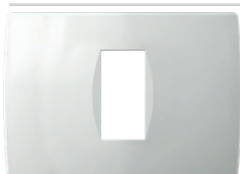

RÁMIK SOFT 1/2M

- dekoračný rámik SOFT 1/2M
- v súlade s normou EN 60669-1

COVER PLATE SOFT 1/2M

- decorative cover plate SOFT 1/2M
- in accordance with EN 60669-1



 OS13PW	 OS13SG
 OS13IW	 OS13NB
 OS13ES	 OS13AT
 OS13SB	 OS13TI
	 OS13WW
	 OS13WE

RÁMIK SOFT 1/3M

- dekoračný rámik SOFT 1/3M
- v súlade s normou EN 60669-1

COVER PLATE SOFT 1/3M

- decorative cover plate SOFT 1/3M
- in accordance with EN 60669-1

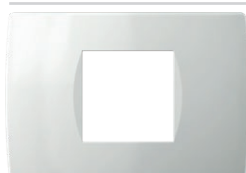

 OS23PW	 OS23SG
 OS23IW	 OS23NB
 OS23ES	 OS23AT
 OS23SB	 OS23TI
	 OS23WW
	 OS23WE

RÁMIK SOFT 2/3M

- dekoračný rámik SOFT 2/3M
- v súlade s normou EN 60669-1

COVER PLATE SOFT 2/3M

- decorative cover plate SOFT 2/3M
- in accordance with EN 60669-1



LASEROVÁ TLAČ NA RÁMIKY

- laserová tlač akejkoľvek grafiky
- výroba na objednávku
- vhodné pre rámičky OL, OS

LASER PRINT ON COVER PLATES

- laser print of any graphics
- made on request
- suitable for cover plates OL, OS



DEKORÁCIE RÁMIKOV







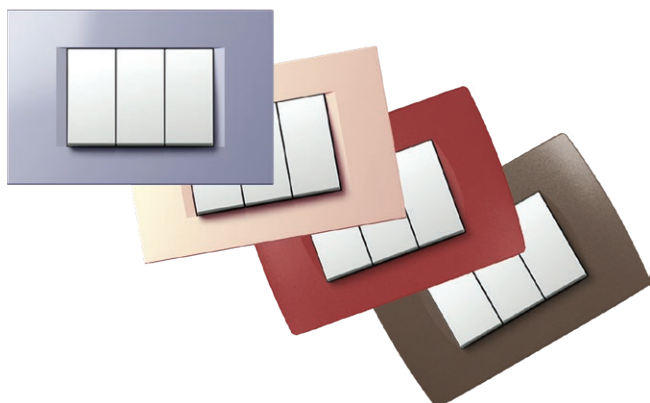

- prispôbitelné textúry a farby
- výroba na objednávku
- vhodné pre rámičky OL, OS

COVER PLATES DECORATIONS

- customised textures and colours
- made on request
- suitable for cover plates OL, OS

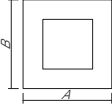
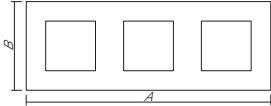
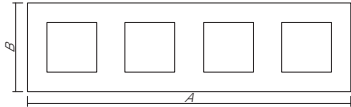

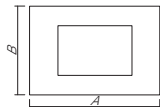
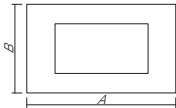
F R A M E S

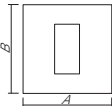
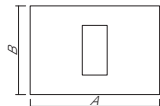
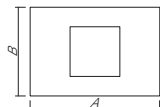
	 line A x B	 soft A x B	 PURE A x B
2M 	80 x 80 mm	84 x 84 mm	93 x 90 mm
2x2M 	151 x 80 mm	155 x 84 mm	164 x 90 mm
3x2M 	222 x 80 mm	226 x 84 mm	235 x 90 mm
4x2M 	293 x 80 mm	297 x 84 mm	304 x 90 mm
			
3M 	122 x 80 mm	122 x 84 mm	134 x 90 mm
4M 	149 x 80 mm	144 x 84 mm	157 x 90 mm
7M 	207 x 80 mm	212 x 84 mm	224 x 90 mm
2x7M 		212 x 158 mm	
			
1/2M 	80 x 80 mm	84 x 84 mm	
1/3M 	122 x 80 mm	122 x 84 mm	134 x 90 mm
2/3M 	122 x 80 mm	122 x 84 mm	134 x 90 mm

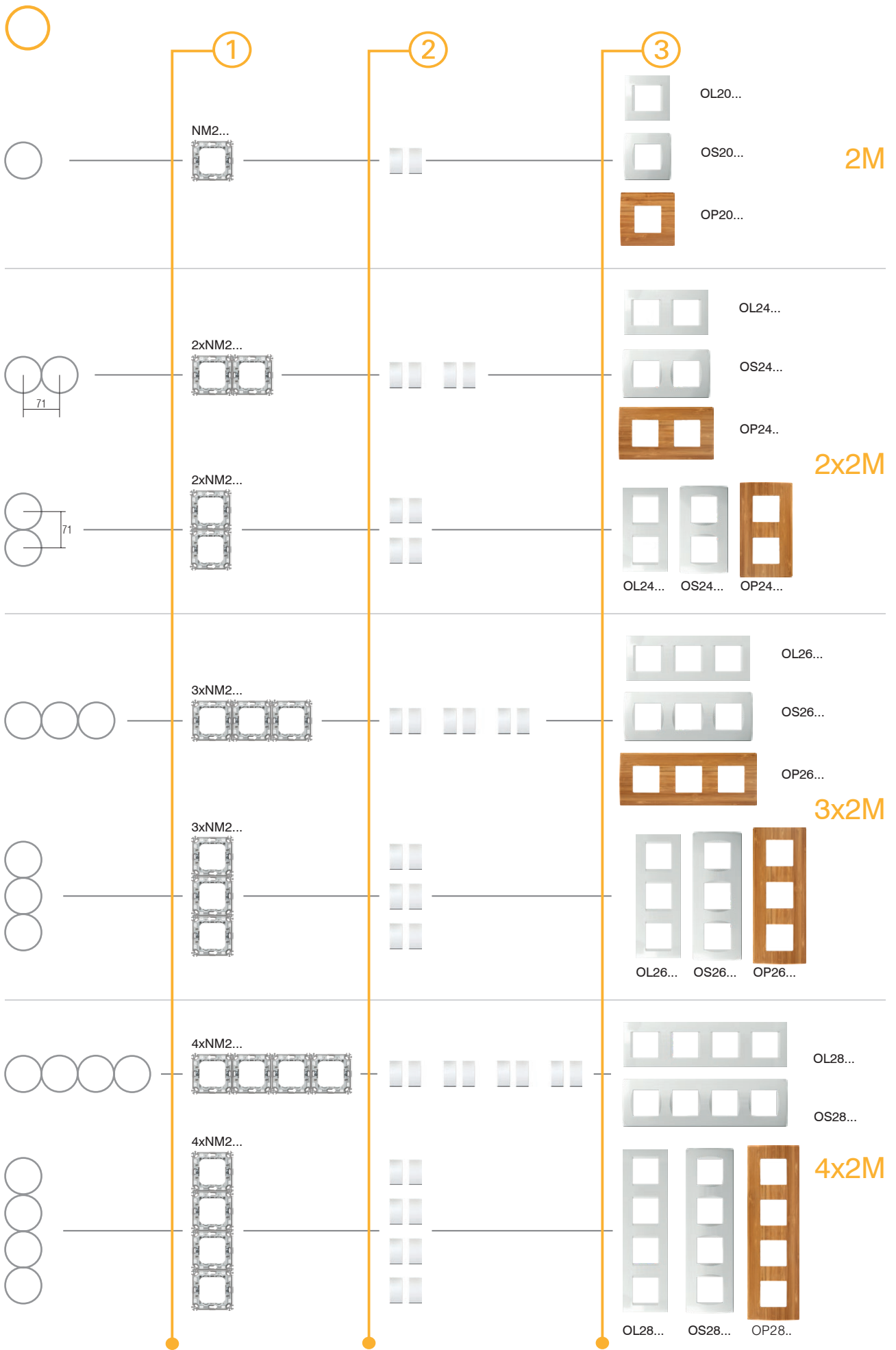

COMBINATIONS

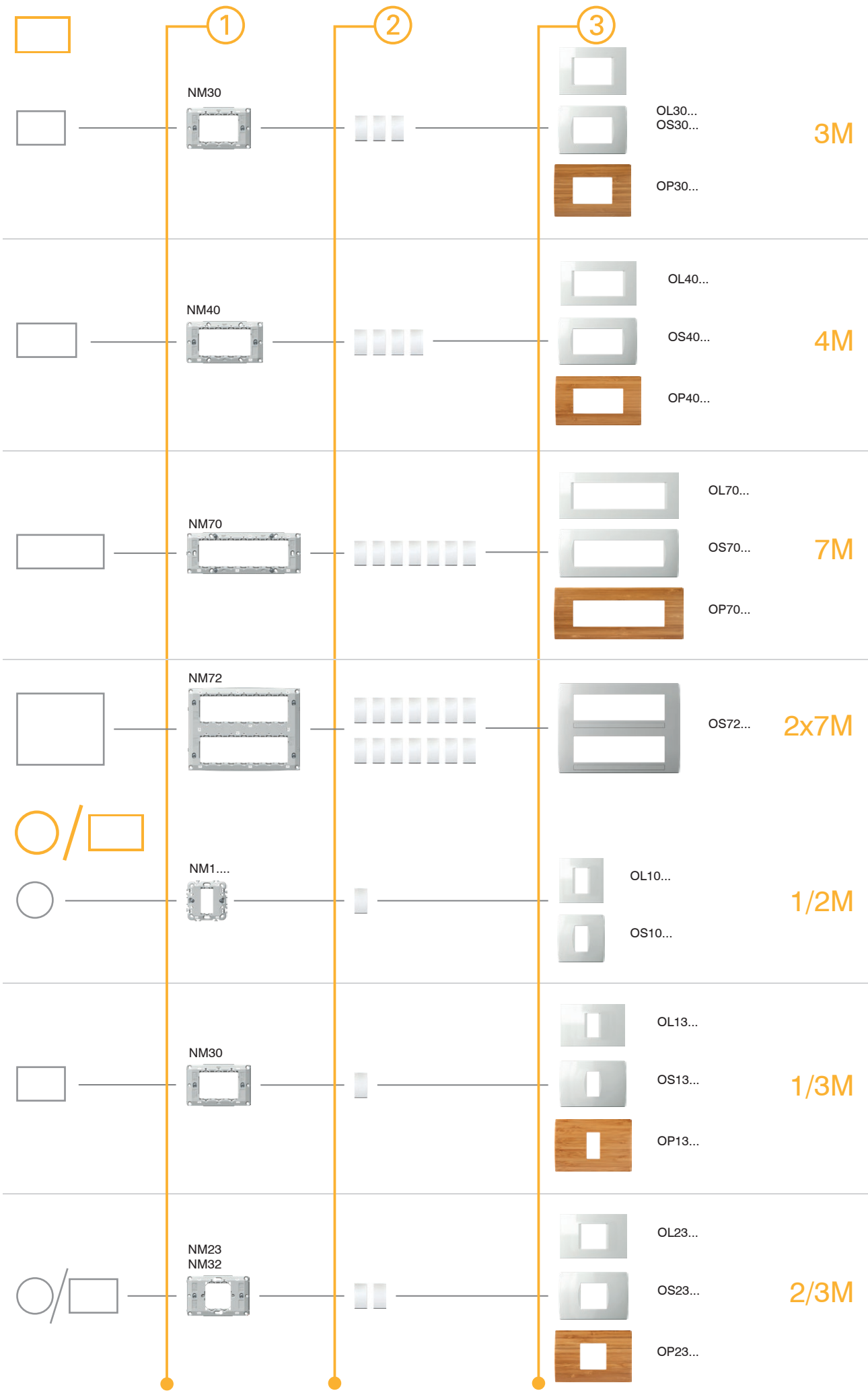

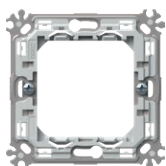
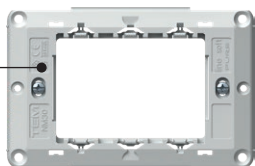

NM30

typ type	popis description	veľkosť size
NM10	MONTÁŽNY RÁM S ROZPERKAMI MOUNTING FRAME WITH CLAWS	1/2M
NM11	MONTÁŽNY RÁM BEZ SKRUTIEK MOUNTING FRAME WITHOUT SCREWS	1/2M
NM20	MONTÁŽNY RÁM S ROZPERKAMI MOUNTING FRAME WITH CLAWS	2M
⋮	⋮	⋮



MONTÁŽNY RÁM S ROZPERKAMI 2M

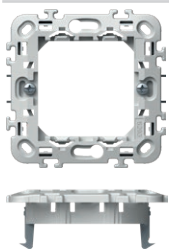

NM20

- montážny rám 2M s rozperkami
- montáž na škatule s priemerom Ø 60 mm (DE...) s rozperkami
- možná horizontálna alebo vertikálna kombinácia 2 x 2M, 3 x 2M a 4 x 2M
- vhodné na montáž s krytmi rady LINE a SOFT
- v súlade s normou EN 60669-1

MOUNTING FRAME WITH CLAWS 2M

- mounting frame 2M with claws
- for mounting on boxes Ø60 (DE..) with claws
- possible horizontal or vertical combinations 2x2M, 3x2M and 4x2M
- suitable for assembling with cover plates LINE and SOFT
- in accordance with EN 60669-1

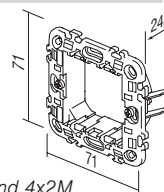

MONTÁŽNY RÁM BEZ SKRUTIEK 2M

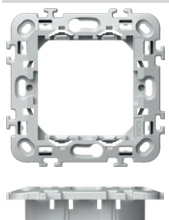

NM21

- montážny rám 2M bez skrutiek a rozperiek
- montáž na škatule s priemerom Ø 60 mm (HE..., BE...) pomocou skrutiek
- možná horizontálna alebo vertikálna kombinácia 2 x 2M, 3 x 2M a 4 x 2M
- vhodné na montáž s krytmi rady LINE a SOFT
- v súlade s normou EN 60669-1

MOUNTING FRAME WITHOUT SCREWS 2M

- mounting frame 2M without screws and without claws
- for mounting in boxes Ø60 (HE..., BE...) with screws
- possible horizontal or vertical combinations 2x2M, 3x2M and 4x2M
- suitable for assembling with cover plates LINE and SOFT
- in accordance with EN 60669-1

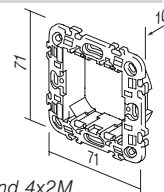

MONTÁŽNY KOVOVÝ RÁM S ROZPERKAMI 2M

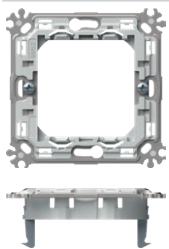

NM24

- kovový montážny rám 2M s rozperkami – pevná verzia
- montáž na škatule s priemerom Ø 60 mm (DE...) s rozperkami
- možná horizontálna alebo vertikálna kombinácia 2 x 2M, 3 x 2M a 4 x 2M
- vhodné na montáž s rámkami rady PURE, LINE a SOFT
- v súlade s normou EN 60669-1

MOUNTING FRAME METAL WITH CLAWS 2M

- metal mounting frame 2M with claws - stiff version
- for mounting on boxes Ø60 (DE..) with claws
- possible horizontal or vertical combinations 2x2M, 3x2M and 4x2M
- suitable for assembling with cover plates PURE, LINE and SOFT
- in accordance with EN 60669-1

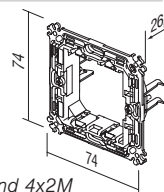

MONTÁŽNY KOVOVÝ RÁM BEZ SKRUTIEK 2M

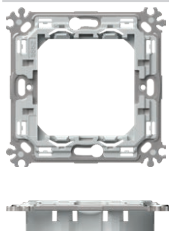

NM25

- montážny kovový rám 2M bez skrutiek a rozperiek – pevná verzia
- montáž na škatule s priemerom Ø 60 mm (HE..., BE...) pomocou skrutiek
- možná horizontálna alebo vertikálna kombinácia 2 x 2M, 3 x 2M a 4 x 2M
- vhodné na montáž s rámkami rady PURE, LINE a SOFT
- v súlade s normou EN 60669-1

MOUNTING FRAME METAL WITHOUT SCREWS 2M

- metal mounting frame 2M without screws and without claws - stiff version
- for mounting in boxes Ø60 (HE..., BE...) with screws
- possible horizontal or vertical combinations 2x2M, 3x2M and 4x2M
- suitable for assembling with cover plates PURE, LINE and SOFT
- in accordance with EN 60669-1

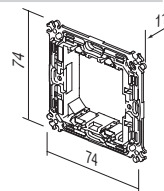

M O U N T I N G F R A M E S N M



NM30

MONTÁŽNY RÁM SO SKRUTKAMI 3M

- montážny rám 3M so skrutkami
- pre montáž na obdĺžnikové krabice 3M
- vhodné na montáž s rámkami rady PURE, LINE a SOFT
- v súlade s normou EN 60669-1

MOUNTING FRAME WITH SCREWS 3M

- mounting frame 3M with screws
- for mounting on rectangular boxes 3M
- suitable for assembling with cover plates PURE, LINE and SOFT
- in accordance with EN 60669-1

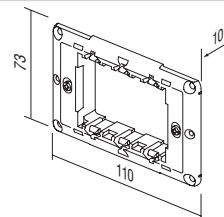

NM40

MONTÁŽNY RÁM SO SKRUTKAMI 4M

- montážny rám 4M so skrutkami
- pre montáž na obdĺžnikové krabice 4M
- vhodné na montáž s rámkami rady PURE, LINE a SOFT
- v súlade s normou EN 60669-1

MOUNTING FRAME WITH SCREWS 4M

- mounting frame 4M with screws
- for mounting on rectangular boxes 4M
- suitable for assembling with cover plates PURE, LINE and SOFT
- in accordance with EN 60669-1

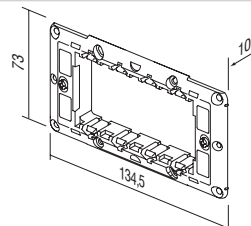

NM70

MONTÁŽNY RÁM SO SKRUTKAMI 7M

- montážny rám 7M so skrutkami
- pre montáž na obdĺžnikové krabice 7M
- vhodné na montáž s rámkami rady PURE, LINE a SOFT
- v súlade s normou EN 60669-1

MOUNTING FRAME WITH SCREWS 7M

- mounting frame 7M with screws
- for mounting on rectangular boxes 7M
- suitable for assembling with cover plates PURE, LINE and SOFT
- in accordance with EN 60669-1

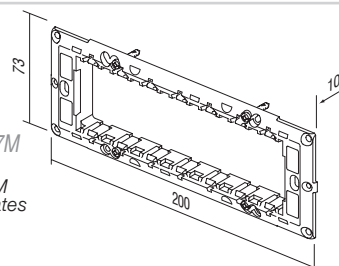

NM72

MONTÁŽNY RÁM SO SKRUTKAMI 2 x 7M

- montážny rám 2x7M so skrutkami
- pre montáž na obdĺžnikové krabice 2 x 7M
- vhodné pre montáž s rámkami rady SOFT OS72
- v súlade s normou EN 60669-1

MOUNTING FRAME WITH SCREWS 2x7M

- mounting frame 2x7M with screws
- for mounting on rectangular boxes 2x7M
- suitable for assembling with cover plate SOFT OS72
- in accordance with EN 60669-1

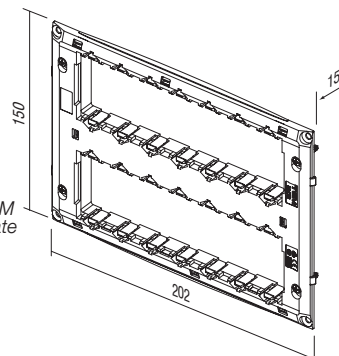

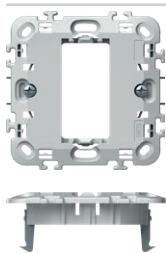

NM10

MONTÁŽNY RÁM S ROZPERKAMI 1/2M

- montážny rám 1/2M s rozperkami
- montáž na škatule s priemerom Ø 60 mm (DE...) s rozperkami
- vhodné na montáž s krytmi rady LINE a SOFT
- v súlade s normou EN 60669-1

MOUNTING FRAME WITH CLAWS 1/2M

- mounting frame 1/2M with claws
- for mounting on boxes Ø60 (DE..) with claws
- suitable for assembling with cover plates LINE and SOFT
- in accordance with EN 60669-1

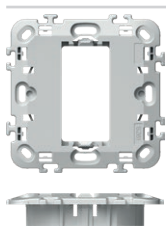
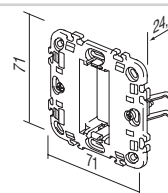

NM11

MONTÁŽNY RÁM BEZ SKRUTIEK 1/2M

- montážny rám 1/2M bez skrutiek a rozperok
- montáž na škatule s priemerom Ø 60 mm (HE..., BE...) pomocou skrutiek
- vhodné na montáž s rámkami rady LINE a SOFT
- v súlade s normou EN 60669-1

MOUNTING FRAME WITHOUT SCREWS 1/2M

- mounting frame 1/2M without screws and without claws
- for mounting on boxes Ø60 (HE..., BE..) with screws
- suitable for assembling with cover plates LINE and SOFT
- in accordance with EN 60669-1

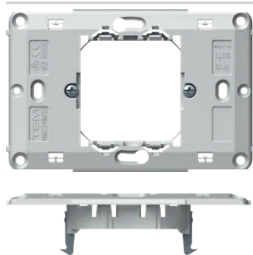
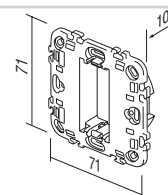

NM23

MONTÁŽNY RÁM S ROZPERKAMI 2/3M

- montážny rám 2/3M so svorkami
- montáž na škatule s priemerom Ø 60 mm (DE...) s rozperkami
- vhodné na montáž s rámkami rady PURE, LINE a SOFT
- v súlade s normou EN 60669-1

MOUNTING FRAME WITH CLAWS 2/3M

- mounting frame 2/3M with claws
- for mounting on boxes Ø60 (DE..) with claws
- suitable for assembling with cover plates PURE, LINE and SOFT
- in accordance with EN 60669-1

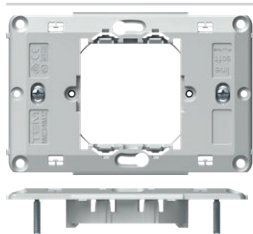
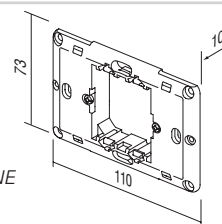

NM32

MONTÁŽNY RÁM SO SKRUTKAMI 2/3M

- montážny rám 2/3M so skrutkami
- pre montáž na obdĺžnikové krabice 3M
- vhodné na montáž s rámkami rady PURE, LINE a SOFT
- v súlade s normou EN 60669-1

MOUNTING FRAME WITH SCREWS 2/3M

- mounting frame 2/3M with screws
- for mounting on rectangular boxes 3M
- suitable for assembling with cover plates PURE, LINE and SOFT
- in accordance with EN 60669-1

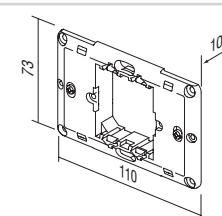

TEM

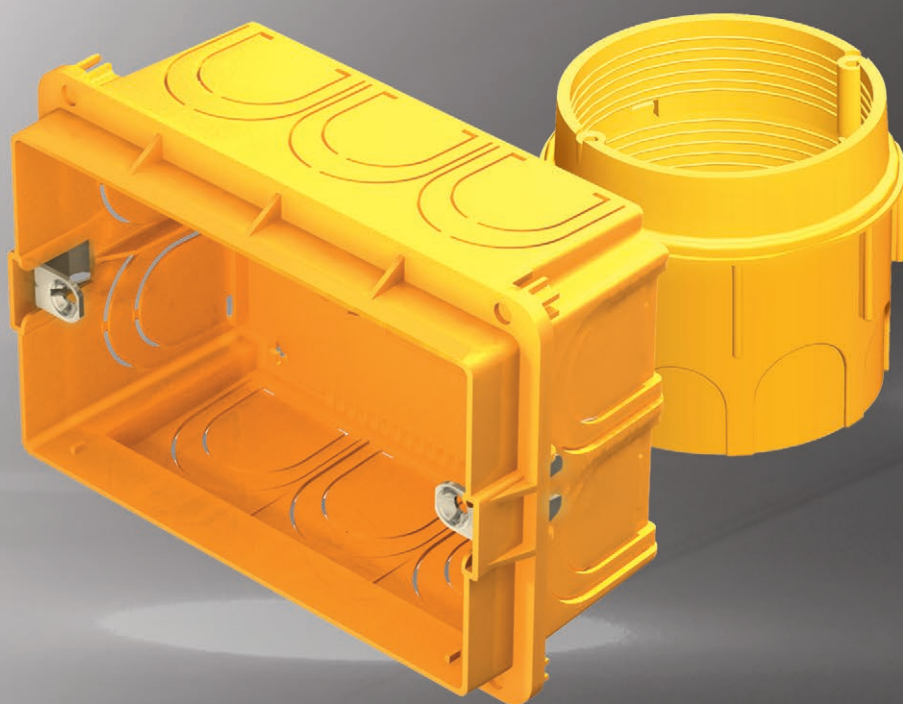

KRABICE



OKRÚHLE KRABICE
ROUND BOXES



140

OBĎŹNIKOVÉ KRABICE
RECTANGULAR BOXES



148

ROZVODNÉ KRABICE
JUNCTION BOXES



156

ELEKTROINŠTALAČNÝ MATERIÁL
WIRING ACCESSORIES



158



DE12



HE11



BE10

typ type	popis description	veľkosť size
DE10	OKRÚHLA KRABICA DO STENY ROUND BOX BRICK	SM60-01
HE10	OKRÚHLA KRABICA – DUTÁ PRIEČKA ROUND BOX HOLLOW WALL	SM68X40
BE10	OKRÚHLA KRABICA – BETÓN ROUND BOX CONCRETE	
⋮	⋮	⋮

OKRÚHLA KRABICA DO STENY SM60-01



DE10

- Ø 60, hĺbka 40 mm
- 650 °C, 500 V ~
- v súlade s normou IEC 60670-1
- bezhalogénová

ROUND BOX BRICK SM60-01

- Ø60, depth 40mm
- 650°C, 500V~
- in accordance with IEC 60670-1
- halogen free

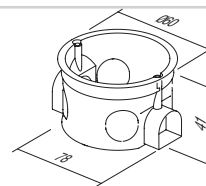

OKRÚHLA KRABICA DO STENY HLBOKÁ SM60-06



DE11

- Ø 60, hĺbka 60mm
- 650 °C, 500 V ~
- v súlade s normou IEC 60670-1
- bezhalogénová

ROUND BOX BRICK DEEP SM60-06

- Ø60, depth 60mm
- 650°C, 500V~
- in accordance with IEC 60670-1
- halogen free

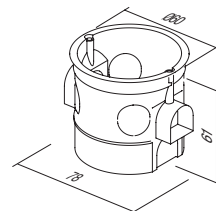

SPOJOVACÍ ČLÁNOK NA KRABICE DO STENY SM60-03



DE30

- na vertikálne spojenie krabíc SM60-06 alebo SM60-01 vo vzdialenosti 91 mm
- v súlade s normou IEC 60670-1
- bezhalogénová

COMBI-CLIP SM60-03

- for vertical fitting of boxes SM60-06 or SM60-01 on distance 91 mm
- in accordance with IEC 60670-1
- halogen free

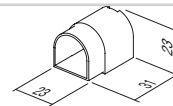

SPOJOVACÍ ČLÁNOK NA KRABICE DO STENY SM60-04



DE31

- na horizontálnu montáž krabíc SM60-06 alebo SM60-01 vo vzdialenosti 71 mm
- v súlade s normou IEC 60670-1
- bezhalogénová

COMBI-CLIP SM60-04

- for horizontal fitting of boxes SM60-06 or SM60-01 on distance 71mm
- in accordance with IEC 60670-1
- halogen free

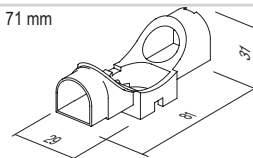

R O U N D B O X E S

	DE12	OKRÚHLA KRABICA DO STENY MD65-46	<ul style="list-style-type: none"> - Ø 65, hĺbka 46 mm - 650 °C, 500 V ~ - v súlade s normou IEC 60670-1 - bezhalogénová 	
		<i>ROUND BOX BRICK MD65-46</i>	<ul style="list-style-type: none"> - Ø65, depth 46mm - 650°C, 500V~ - in accordance with IEC 60670-1 - halogen free 	
	DE13	OKRÚHLA KRABICA DO STENY HLBOKÁ MD65-60	<ul style="list-style-type: none"> - Ø 65/60, hĺbka 62 mm - 650 °C, 500 V ~ - v súlade s normou IEC 60670-1 - bezhalogénová 	
		<i>ROUND BOX BRICK DEEP MD65-60</i>	<ul style="list-style-type: none"> - Ø65/60, depth 62mm - 650°C, 500V~ - in accordance with IEC 60670-1 - halogen free 	
	DE14	PREHLBENIE PRE MD65-46	<ul style="list-style-type: none"> - Ø 65/60, hĺbka 17mm - 650 °C, 500 V ~ - v súlade s normou IEC 60670-1 - bezhalogénová 	
		<i>ADDITIONAL PIECE FOR MD65-46</i>	<ul style="list-style-type: none"> - Ø65/60, depth 17mm - 650°C, 500V~ - in accordance with IEC 60670-1 - halogen free 	
	DE32	SPOJOVACÍ ČLÁNOK NA KRABICE DO STENY MD65-71	<ul style="list-style-type: none"> - na montáž krabic MD65 na vzdialenosť 71 mm - v súlade s normou IEC 60670-1 - bezhalogénová 	
		<i>COMBI-CLIP MD65-71</i>	<ul style="list-style-type: none"> - for fitting of boxes MD65 on distance 71mm - in accordance with IEC 60670-1 - halogen free 	
	DE33	SPOJOVACÍ ČLÁNOK NA KRABICE DO STENY MD65-91	<ul style="list-style-type: none"> - na montáž krabic MD65 na vzdialenosť 91mm - v súlade s normou IEC 60670-1 - bezhalogénová 	
		<i>COMBI-CLIP MD65-91</i>	<ul style="list-style-type: none"> - for fitting of boxes MD65 on distance 91mm - in accordance with IEC 60670-1 - halogen free 	
	DE20	OCHRANNÝ KRYT KRABICE 60	<ul style="list-style-type: none"> - ochranný kryt na krabicu Ø 60 pre DE10, DE11, DE13, DE14 - v súlade s normou IEC 60670-1 - ochrana krabice počas omietania 	
		<i>BOX COVER PROTECTIVE 60</i>	<ul style="list-style-type: none"> - protective cover for box Ø60 for DE10, DE11, DE13, DE14 - in accordance with IEC 60670-1 - box protection during plastering 	
	DE21	OCHRANNÝ KRYT KRABICE 65	<ul style="list-style-type: none"> - ochranný kryt na krabicu Ø 65 pre DE12 - v súlade s normou IEC 60670-1 - ochrana krabice počas omietania 	
		<i>BOX COVER PROTECTIVE 65</i>	<ul style="list-style-type: none"> - protective cover for box Ø65 for DE12 - in accordance with IEC 60670-1 - box protection during plastering 	
	DE22	KRYT KRABICE SM60	<ul style="list-style-type: none"> - kryt na krabicu Ø 60 mm - v súlade s normou IEC 60670-1 - bezhalogénová 	
		<i>BOX COVER DECORATIVE SM60</i>	<ul style="list-style-type: none"> - decorative cover for boxes Ø60 - in accordance with IEC 60670-1 - halogen free 	



pokyny na montáž /
assembly instructions

vzdialenosť medzi krabicami /
distance between boxes: 71 mm

vzdialenosť medzi krabicami /
distance between boxes: 91 mm

DE10,11

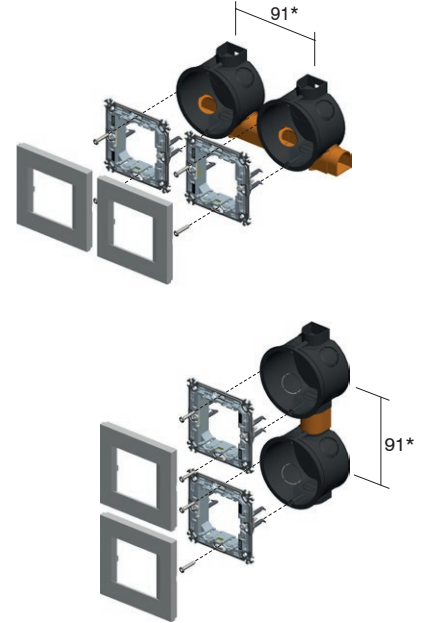
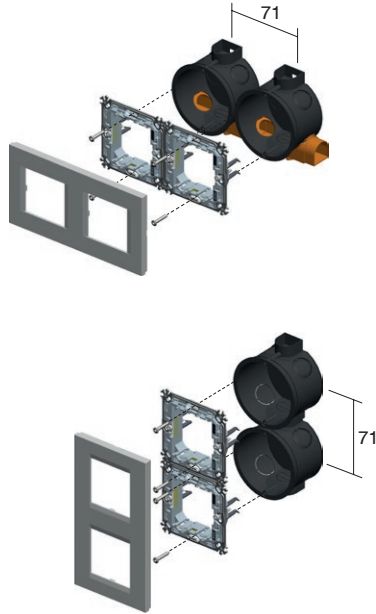
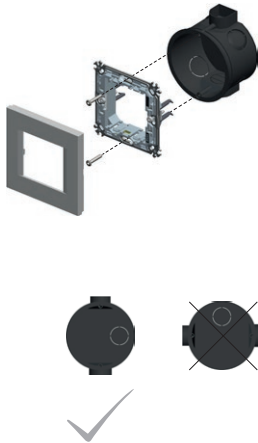

DE12,13

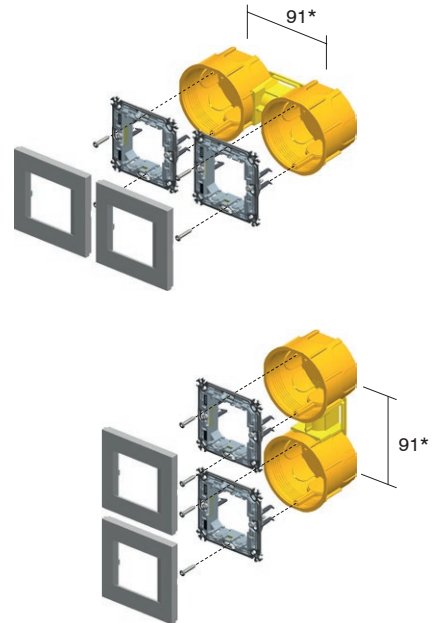
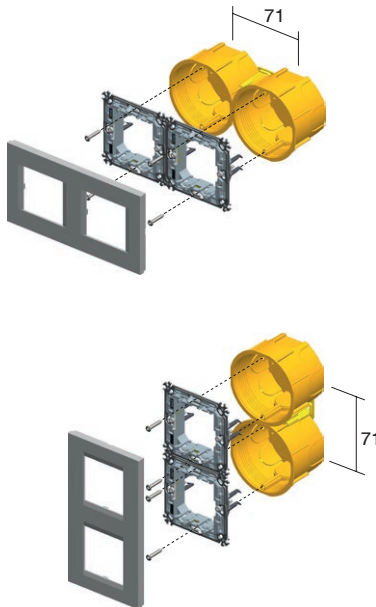
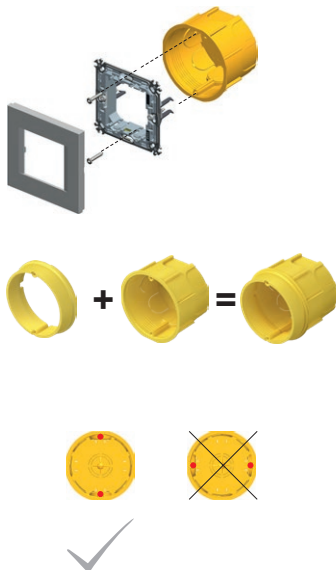

* Pri rámkoch rady PURE je minimálna vzdialenosť medzi krabicami 100 mm
* for PURE cover plates the minimum distance between boxes is 100mm

R O U N D B O X E S



DE10,11



NM20



DE12,13



NM24



DE10,11



NM10



DE12,13



71

2xDE10,11 + 2xDE31



2xNM20



2xDE12,13 + 1xDE32



2xNM24



2xDE10,11 2xDE12,13 + 1xDE32

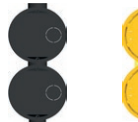

2xNM20



2xNM24



3xDE10,11 + 3xDE31



3xNM20



3xDE12,13 + 2xDE32



3xNM24



3xDE10,11 3xDE12,13 + 2xDE32

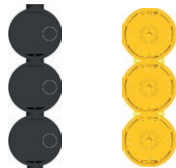

3xNM20

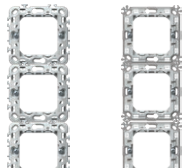

3xNM24

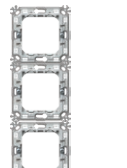

4xDE10,11 + 4xDE31



4xNM20



4xDE12,13 + 3xDE32



4xNM24



4xDE10,11 4xDE12,13 + 3xDE32

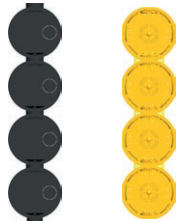

4xNM20

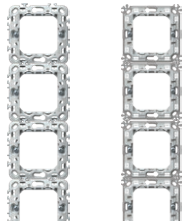

4xNM24

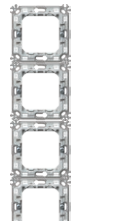

OKRŮHLA KRABICA – DUTÁ PRIEČKA SM68x40



HE10

- Ø 60 mm, hĺbka 40 mm
- montážny otvor Ø68 mm
- 850 °C, 400 V ~
- v súlade s normou IEC 60670-1
- montáž so svorkami
- bezhalogénová

ROUND BOX HOLLOW WALL SM68x40

- Ø60, depth 40mm
- cutting hole Ø68
- 850 °C, 400V~
- in accordance with IEC 60670-1
- mounting with claws
- halogen free

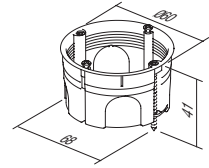

OKRŮHLA KRABICA – DUTÁ PRIEČKA SM68x55



HE11

- Ø 60 mm, hĺbka 55 mm
- montážny otvor Ø68 mm
- 850 °C, 400 V ~
- v súlade s normou IEC 60670-1
- montáž so svorkami
- bezhalogénová

ROUND BOX HOLLOW WALL SM68x55

- Ø60, depth 55mm
- cutting hole Ø68
- 850 °C, 400V~
- in accordance with IEC 60670-1
- mounting with claws
- halogen free

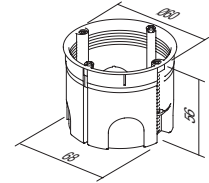

OKRŮHLA KRABICA – BETÓN



BE10

- Ø 60mm, hĺbka 49 mm
- 650 °C, 500 V ~
- v súlade s normou IEC 60670-1
- bezhalogénová

ROUND BOX CONCRETE

- Ø60mm, depth 49mm
- 650 °C, 500V~
- in accordance with IEC 60670-1
- halogen free

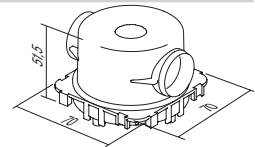

OKRŮHLA KRABICA – BETÓN HLBOKÁ



BE11

- Ø 60mm, hĺbka 58mm
- 650 °C, 500 V ~
- v súlade s normou IEC 60670-1
- bezhalogénová

ROUND BOX CONCRETE DEEP

- Ø60mm, depth 58mm
- 650 °C, 500V~
- in accordance with IEC 60670-1
- halogen free

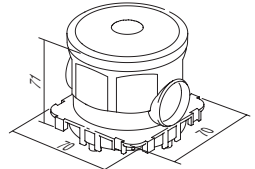

MONTÁŽNY RÁM KRABICE DO BETÓNU



BE20

- na upevnenie krabice s dištančným profilom BM82 pre extrémne zaťaženie
- v súlade s normou IEC 60670-1
- bezhalogénová

COUNTER BOX SUPPORT CONCRETE

- to support concrete boxes with distance profile BM82 for extreme loads
- in accordance with IEC 60670-1
- halogen free

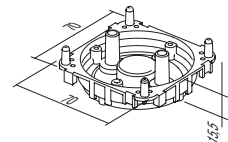

PRIECHODKA KRABICE DO BETÓNU 16



BE21

- na upevnenie inštaláčnej rúry ku krabici
- v súlade s normou IEC 60670-1
- bezhalogénová

PIPE STOPPER CONCRETE BOX 16

- for firming installation pipe to box
- in accordance with IEC 60670-1
- halogen free

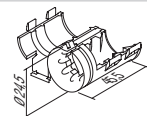

R O U N D B O X E S

duté priečky / hollow walls

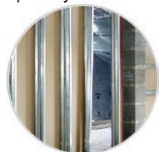

betón / concrete



pokyny na montáž /
assembly instructions

vzdialenosť medzi krabicami /
distance between boxes: 71mm

vzdialenosť medzi krabicami /
distance between boxes: 91mm

HE10,11

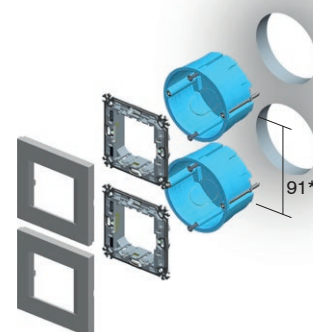
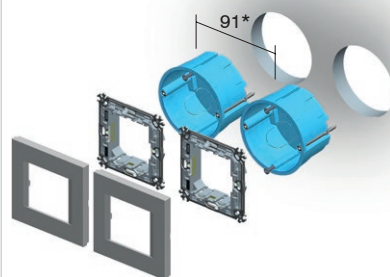
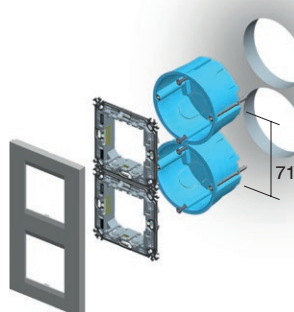
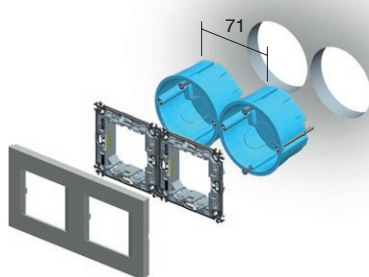
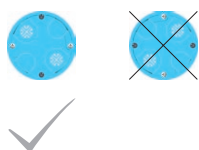
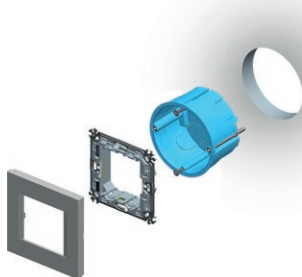

BE10

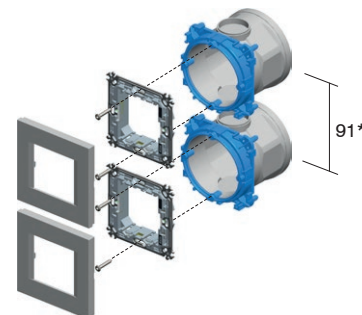
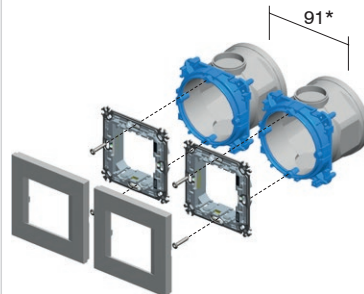
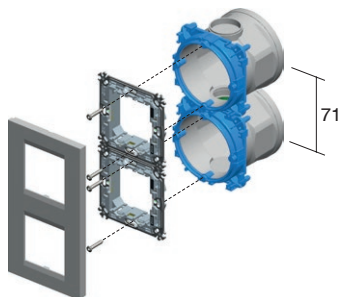
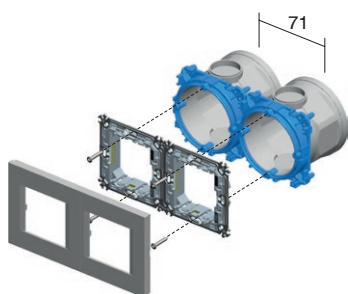
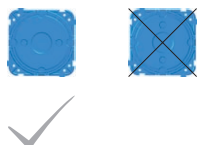

* Pri rámkoch rady PURE je minimálna vzdialenosť medzi krabicami 100 mm

* for PURE cover plates the minimum distance between boxes is 100mm

duté priečky / hollow walls



betón / concrete



HE10,11



BE10,11



NM21



NM25



2M

HE10,11



BE10,11



NM11



1/2M

2xHE10,11



2xBE10,11



2xNM21



2xNM25



2x2M

HE10,11



BE10,11



NM32



2/3M

2xHE10,11



2xBE10,11



2xNM21



2xNM25



3xHE10,11

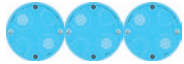

3xBE10,11



3xNM21



3xNM25



3x2M

3xHE10,11



3xBE10,11



3xNM21



3xNM25



4xHE10,11



4xBE10,11



4xNM21



4xNM25



4x2M

4xHE10,11



4xBE10,11



4xNM21



4xNM25



R O U N D B O X E S

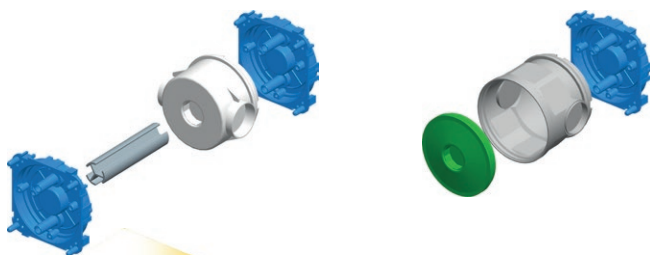

pokyny na montáž /
assembly instructions

1

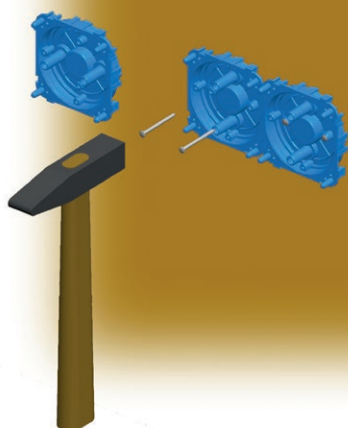

3

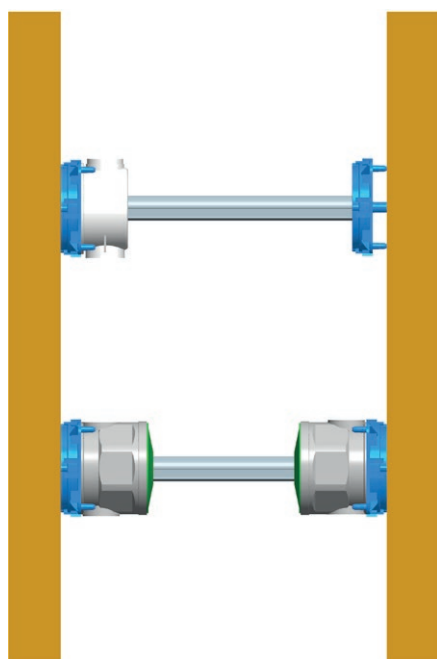

2

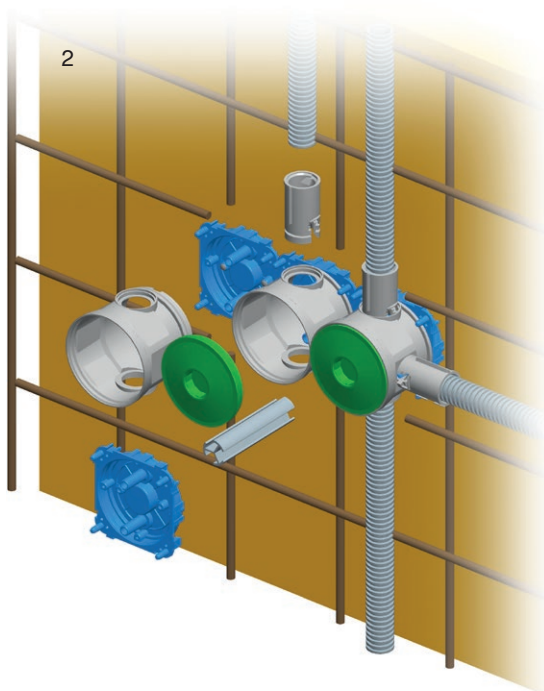

4

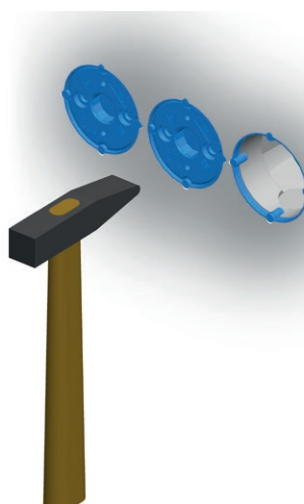



DM30



HM30



BM30

typ type	popis description	veľkosť size
DM30	OBDĽŽNIKOVÁ KRABICA DO STENY RECTANGULAR BOX BRICK	PM3
HM30	OBDĽŽNIKOVÁ KRABICA – DUTÉ PRIEČKY RECTANGULAR BOX HOLLOW WALL	VM3
BM30	OBDĽŽNIKOVÁ KRABICA – BETÓN RECTANGULAR BOX CONCRETE	BM3
...

OBDĽŽNIKOVÁ KRABICA DO STENY PM3



DM30

- veľkosť 3M, hĺbka 49 mm
- 650 °C, 400 V ~
- v súlade s normou IEC 60670-1
- bezhalogénová

RECTANGULAR BOX BRICK PM3

- size 3M, depth 49mm
- 650 °C, 400V ~
- in accordance with IEC 60670-1
- halogen free

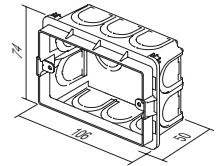

OBDĽŽNIKOVÁ KRABICA DO STENY PM3-65



DM31

- veľkosť 3M, hĺbka 65 mm
- 650 °C, 400 V ~
- v súlade s normou IEC 60670-1
- bezhalogénová

RECTANGULAR BOX BRICK PM3-65

- size 3M, depth 65mm
- 650 °C, 400V ~
- in accordance with IEC 60670-1
- halogen free

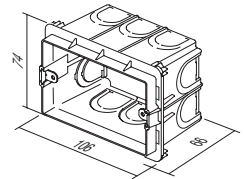

OBDĽŽNIKOVÁ KRABICA DO STENY PM4



DM40

- veľkosť 4M, hĺbka 49 mm
- 650 °C, 400 V ~
- v súlade s normou IEC 60670-1
- bezhalogénová

RECTANGULAR BOX BRICK PM4

- size 4M, depth 49mm
- 650 °C, 400V ~
- in accordance with IEC 60670-1
- halogen free

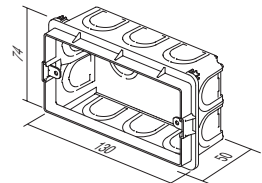

OBDĽŽNIKOVÁ KRABICA DO STENY PM4-65



DM41

- veľkosť 4M, hĺbka 65 mm
- 650 °C, 400 V ~
- v súlade s normou IEC 60670-1
- bezhalogénová

RECTANGULAR BOX BRICK PM4-65

- size 4M, depth 65mm
- 650 °C, 400V ~
- in accordance with IEC 60670-1
- halogen free

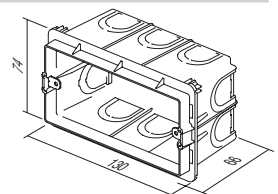

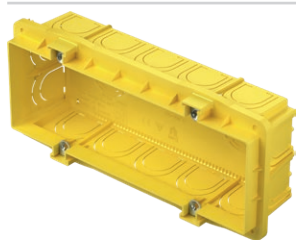

DM70

OBDĹŽNIKOVÁ KRABICA DO STENY PM7

- veľkosť 7M, hĺbka 49 mm
- 650 °C, 400 V ~
- v súlade s normou IEC 60670-1
- bezhalogénová

RECTANGULAR BOX BRICK PM7

- size 7M, depth 49mm
- 650°C, 400V~
- in accordance with IEC 60670-1
- halogen free

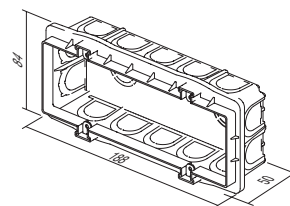

DM71

OBDĹŽNIKOVÁ KRABICA DO STENY PM7-65

- veľkosť 7M, hĺbka 65 mm
- 650 °C, 400 V ~
- v súlade s normou IEC 60670-1
- bezhalogénová

RECTANGULAR BOX BRICK PM7-65

- size 7M, depth 65mm
- 650°C, 400V~
- in accordance with IEC 60670-1
- halogen free

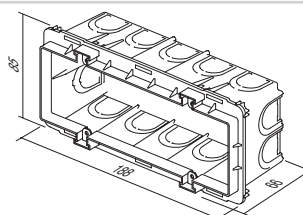

DM72

OBDĹŽNIKOVÁ KRABICA DO STENY PM72-65

- veľkosť 2 x 7M, hĺbka 64 mm
- 650 °C, 400 V ~
- v súlade s normou IEC 60670-1
- bezhalogénová

RECTANGULAR BOX BRICK PM72-65

- size 2x7M, depth 64mm
- 650°C, 400V~
- in accordance with IEC 60670-1
- halogen free

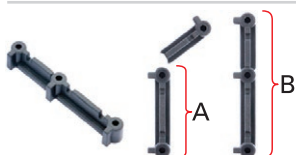
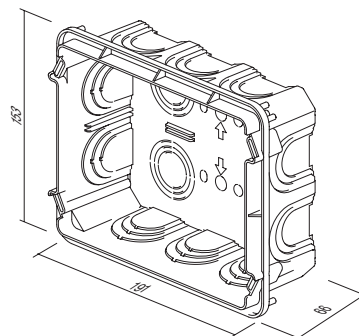

DM80

ROZPERA PRE KRABICU PM

- na vertikálnu (A) a horizontálnu (B) montáž krabic PM3, PM4 a PM7
- vhodné pre dekoratívne krycie lišty Line a Soft (nie pre PURE)

DISTANCE PIECE FOR BOX PM

- for vertical (A) and horizontal (B) fitting of boxes PM3, PM4 and PM7
- suitable for Line and Soft decorative cover plates (not for PURE)

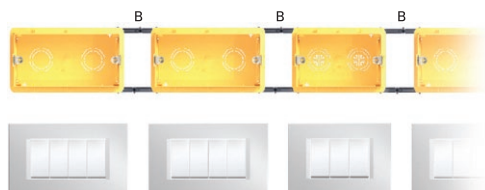
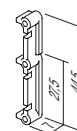



DM33

OCHRANNÝ KRYT PM3

- ochranný kryt pre krabicu PM3
- v súlade s normou IEC 60670-1
- bezhalogénová
- ochrana krabice počas omietania

BOX COVER PROTECTIVE PM3

- protective cover for box PM3
- in accordance with IEC 60670-1
- halogen free
- box protection during plastering

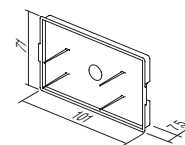

DM34

KRYT KRABICE DEKORATÍVNY PM3

- dekoratívny kryt pre krabicu 3M
- skrutky sú súčasťou dodávky
- v súlade s normou IEC 60670-1
- bezhalogénová

BOX COVER DECORATIVE PM3

- decorative cover for boxes 3M
- screws are included
- in accordance with IEC 60670-1
- halogen free

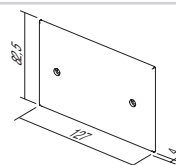

DM43

OCHRANNÝ KRYT PM4

- ochranný kryt pre krabicu PM4
- v súlade s normou IEC 60670-1
- bezhalogénová
- ochrana krabice počas omietania

BOX COVER PROTECTIVE PM4

- protective cover for box PM4
- in accordance with IEC 60670-1
- halogen free
- box protection during plastering

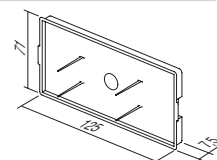

DM44

KRYT KRABICE DEKORATÍVNY PM4

- dekoratívny kryt pre krabicu 4M
- skrutky sú súčasťou dodávky
- v súlade s normou IEC 60670-1
- bezhalogénová

BOX COVER DECORATIVE PM4

- decorative cover for boxes 4M
- screws are included
- in accordance with IEC 60670-1
- halogen free

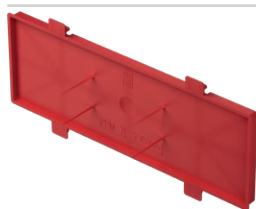
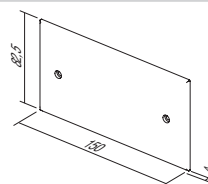

DM73

OCHRANNÝ KRYT PM7

- ochranný kryt pre krabicu PM7
- v súlade s normou IEC 60670-1
- bezhalogénová
- ochrana krabice počas omietania

BOX COVER PROTECTIVE PM7

- protective cover for box PM7
- in accordance with IEC 60670-1
- halogen free
- box protection during plastering

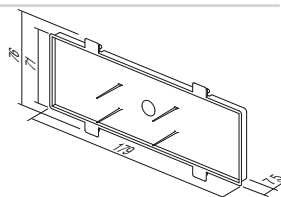

DM74

KRYT KRABICE DEKORATÍVNY PM7

- dekoratívny kryt pre krabicu 7M
- skrutky sú súčasťou dodávky
- v súlade s normou IEC 60670-1
- bezhalogénová

BOX COVER DECORATIVE PM7

- decorative cover for boxes 7M
- screws are included
- in accordance with IEC 60670-1
- halogen free

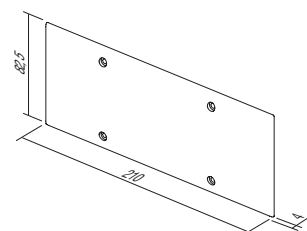



DM75

KRYT KRABICE DEKORATIVNY PM72

- dekoratívny kryt pre krabice 2 x 7M
- skrutky sú súčasťou dodávky
- v súlade s normou IEC 60670-1

BOX COVER DECORATIVE PM72

- decorative cover for boxes 2x7M
- screws are included
- in accordance with IEC 60670-1

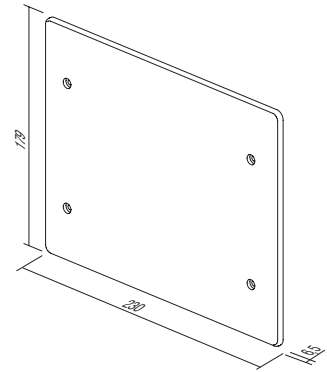



HM30

OVÁLNÁ KRABICA – DUTÁ PRIEČKA VM3

- veľkosť 3M, hĺbka 49 mm
- montážny otvor 2 x Ø 68/45 mm
- 850 °C, 400 V ~
- v súlade s normou IEC 60670-1
- bezhalogénová

RECTANGULAR BOX HOLLOW WALL VM3

- size 3M, depth 49mm
- cutting hole 2xØ68/45mm
- 850°C, 400V~
- in accordance with IEC 60670-1
- halogen free

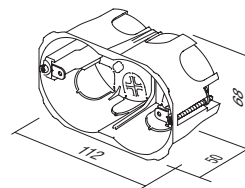

HM40

OVÁLNÁ KRABICA – DUTÁ PRIEČKA VM4

- veľkosť 4M, hĺbka 49 mm
- montážny otvor 2 x Ø 68/70 mm
- 850 °C, 400 V ~
- v súlade s normou IEC 60670-1
- bezhalogénová

RECTANGULAR BOX HOLLOW WALL VM4

- size 4M, depth 49mm
- cutting hole 2xØ68/70mm
- 850°C, 400V~
- in accordance with IEC 60670-1
- halogen free

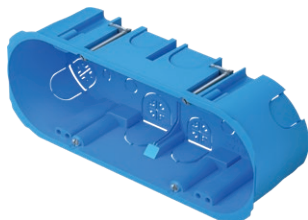
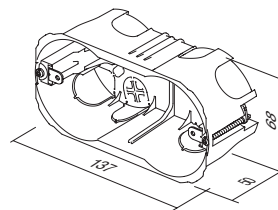

HM70

OVÁLNÁ KRABICA – DUTÁ PRIEČKA VM7

- veľkosť 7M, hĺbka 49 mm
- montážny otvor 2 x Ø 68/120 mm
- 850 °C, 400 V ~
- v súlade s normou IEC 60670-1
- bezhalogénová

RECTANGULAR BOX HOLLOW WALL VM7

- size 7M, depth 49mm
- cutting hole 2xØ68/120mm
- 850°C, 400V~
- in accordance with IEC 60670-1
- halogen free

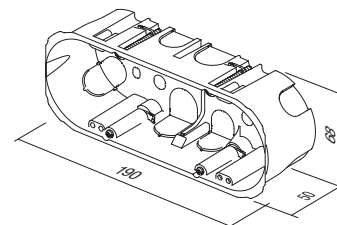

HM72

OBDĽŽNIKOVÁ KRABICA – DUTÁ PRIEČKA VM72

- veľkosť 2 x 7M, hĺbka 63 mm
- 850 °C, 400 V ~
- v súlade s normou IEC 60670-1
- bezhalogénová

RECTANGULAR BOX HOLLOW WALL VM72

- size 2x7M, depth 63mm
- 850°C, 400V~
- in accordance with IEC 60670-1
- halogen free

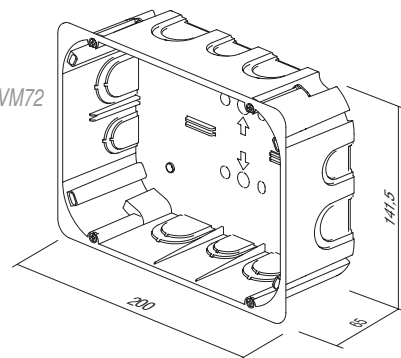



BM30

OBDĹŽNIKOVÁ KRABICA – BETÓN BM3

- veľkosť 3M, hĺbka 60 mm
- 650 °C, 400 V ~
- v súlade s normou IEC 60670-1
- bezhalogénová

RECTANGULAR BOX CONCRETE BM3

- size 3M, depth 60mm
- 650 °C, 400V ~
- in accordance with IEC 60670-1
- halogen free

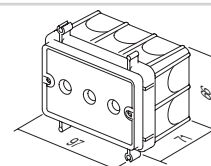

BM40

OBDĹŽNIKOVÁ KRABICA – BETÓN BM4

- veľkosť 4M, hĺbka 60 mm
- 650 °C, 400 V ~
- v súlade s normou IEC 60670-1
- bezhalogénová

RECTANGULAR BOX CONCRETE BM4

- size 4M, depth 60mm
- 650 °C, 400V ~
- in accordance with IEC 60670-1
- halogen free

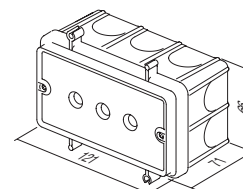

BM70

OBDĹŽNIKOVÁ KRABICA – BETÓN BM7

- veľkosť 7M, hĺbka 60 mm
- 650 °C, 400 V ~
- v súlade s normou IEC 60670-1
- bezhalogénová

RECTANGULAR BOX CONCRETE BM7

- size 7M, depth 60mm
- 650 °C, 400V ~
- in accordance with IEC 60670-1
- halogen free

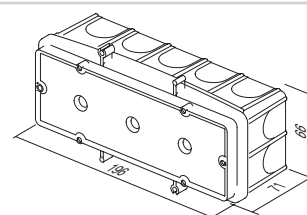

BM80

UPEVŇOVACÍ PRVOK NA KRABICU BM

- pre rýchle upevnenie BM obdĺžnikových skriniek na výstužnú tyč
- vhodné pre priemer tyče až Ø 8 mm

FIXING COMBI-CLIP BM

- for fast fixation of BM rectangular boxes on reinforcing bar
- suitable for bar diameter up to Ø8mm

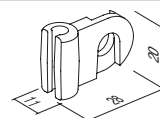

BM82

DIŠŤANČNÝ PROFIL NA KRABICE BM

- na upevnenie krabic BM spolu s montážnym rámkom pre betón do protifahlej steny
- dĺžka l = 1 m, priemer Ø 20 mm

DISTANCE PROFIL FOR BOXES BM

- to support boxes BM with counter box support on opposite wall
- length l=1m, diameter Ø20mm

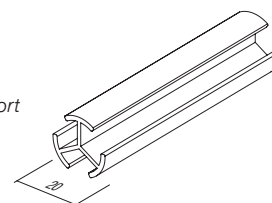



tehla / brick

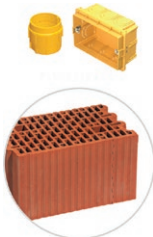

duté priečky / hollow walls

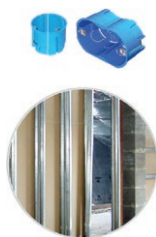

betón / concrete

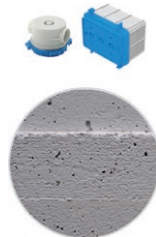

DM30		NM30		3M
HM30				
BM30				
DM40		NM40		4M
HM40				
BM40				
DM70		NM70		7M
HM70				
BM70				
DM72		NM72		2x7M
HM72				
DM30		NM32		2/3M
HM30				
BM30				

R E C T A N G U L A R B O X E S

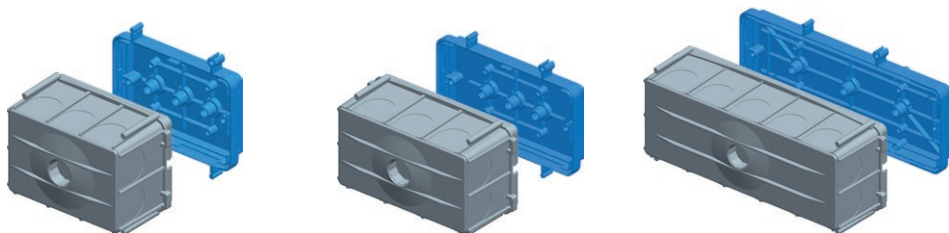

pokyny na montáž /
assembly instructions

1

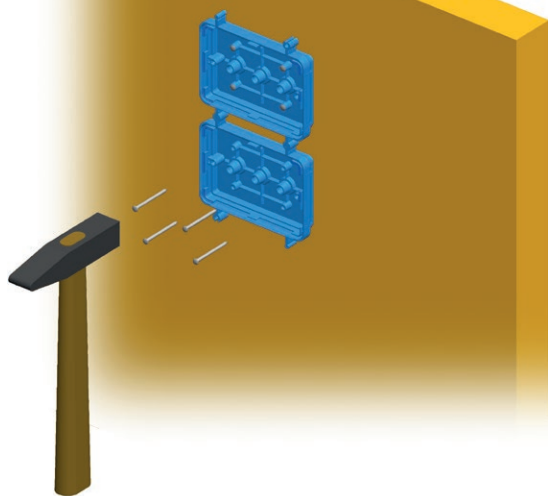

2

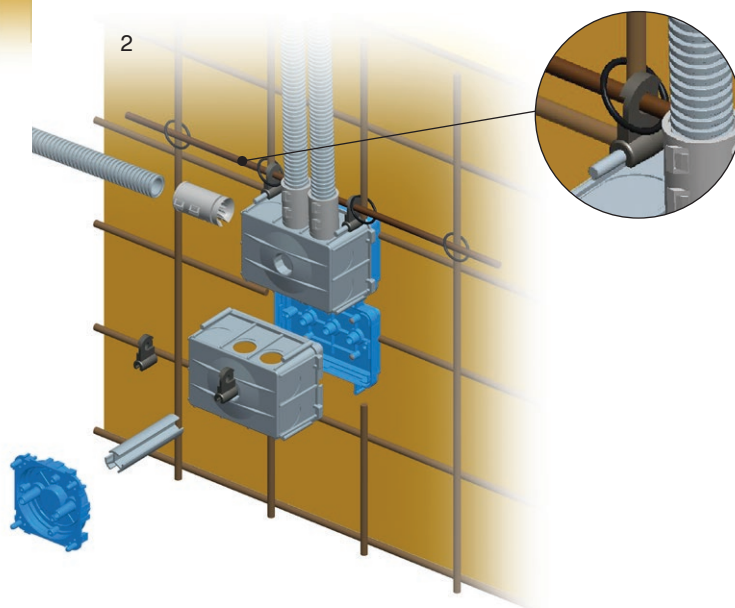

3

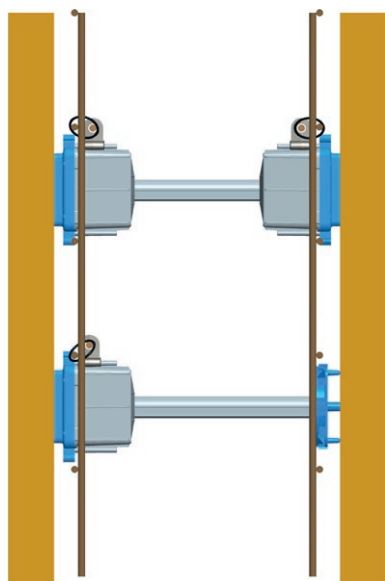

4

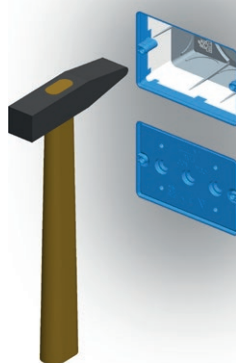



DW10

ROZVODNÁ KRABICA OKRÚHLA DO STENY DSM78

- Ø 78, hĺbka 40 mm
- 650 °C, 500 V ~
- v súlade s normou IEC 60670-1 a IEC 60670-22
- bezhalogénová

CONNECTION ROUND BOX BRICK DSM78

- Ø78, depth 40mm
- 650°C, 500V~
- in accordance with IEC 60670-1 and IEC 60670-22
- halogen free

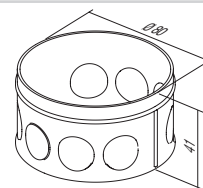

HW10

ROZVODNÁ KRABICA OKRÚHLA – DUTÁ PRIEČKA SM78x45

- Ø 78, hĺbka 45 mm
- vyrezaný otvor Ø80
- 850 °C, 400 V ~
- v súlade s normou IEC 60670-1 a IEC 60670-22
- montáž so svorkami
- bezhalogénová

CONNECTION ROUND BOX HOLLOW WALL SM78x45

- Ø78, depth 45mm
- cutting hole Ø80
- 850°C, 400V~
- in accordance with IEC 60670-1 and IEC 60670-22
- mounting with claws
- halogen free

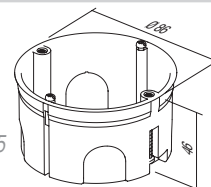

DE23

KRYT KRABICE DEKORATÍVNY SM78

- dekoratívny kryt pre krabice Ø78
- v súlade s normou IEC 60670-1 a IEC 60670-22
- bezhalogénová

BOX COVER DECORATIVE SM78

- decorative cover for boxes Ø78
- in accordance with IEC 60670-1 and IEC 60670-22
- halogen free

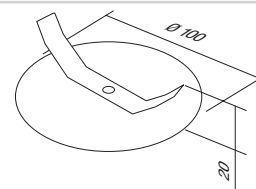

DE24

OCHRANNÝ KRYT KRABICE 78

- ochranný kryt pre krabicu Ø 78
- v súlade s normou IEC 60670-1 a IEC 60670-22
- bezhalogénová

BOX COVER PROTECTIVE 78

- protective cover for box Ø78
- in accordance with IEC 60670-1 and IEC 60670-22
- halogen free

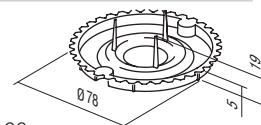

HW20

ROZVODNÁ KRABICA ŠTVORCOVÁ DO STENY SM105x105

- veľkosť 105 x 105mm, hĺbka 50 mm
- montážny otvor podľa priloženej šablóny
- 850 °C, 400 V ~
- v súlade s normou IEC 60670-1 a IEC 60670-22
- montáž so svorkami
- bezhalogénová

CONNECTION SQUARE BOX BRICK SM105x105

- size 105x105mm, depth 50mm
- cutting hole according to attached template
- 850°C, 400V~
- in accordance with IEC 60670-1 and IEC 60670-22
- mounting with claws
- halogen free

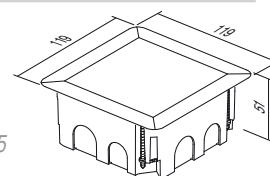

J U N C T I O N B O X E S

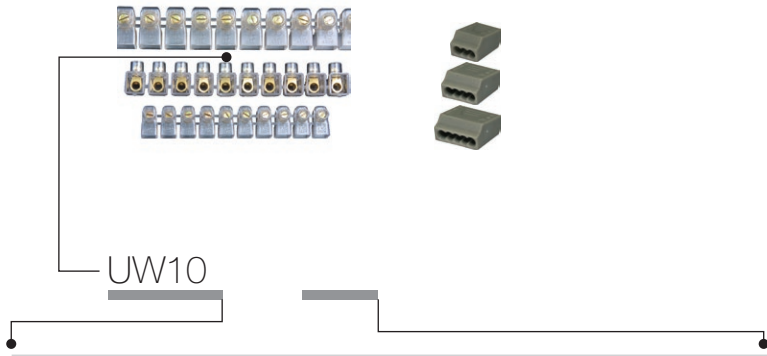

typ type	popis description	technické dáta technical data	veľkosť size	farba colour
UW10	JEDNORADOVÉ SVORKOVNICE 1 ROW TERMINAL BLOCKS	2x2.5mm ²	10P	TS priehľadná transparent
UW11	JEDNORADOVÉ SVORKOVNICE 1 ROW TERMINAL BLOCKS	2x4mm ²	10P	CO farba colour
UW12	JEDNORADOVÉ SVORKOVNICE 1 ROW TERMINAL BLOCKS	2x6mm ²	10P	WH biela white
...	GY sivá grey

JEDNORADOVÉ SVORKOVNICE ZATVORENÉ



- 450 V~; 2 x 2,5 mm² ÷ 2 x 6 mm²
- termoplast PC, priehľadný
- počet pólov: 10

1 ROW TERMINAL BLOCKS CLOSED

- 450V~; 2x2.5mm² ÷ 2x6mm²
- thermoplast PC, transparent
- number of poles: 10

UW10TS	(NS12)	2x2.5mm ²	10P
UW11TS	(NS12)	2x4mm ²	10P
UW12TS	(NS12)	2x6mm ²	10P

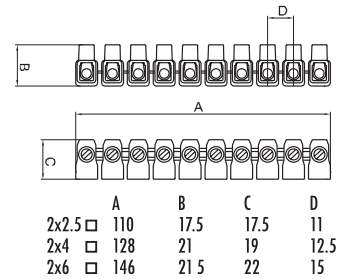

JEDNORADOVÉ SVORKOVNICE

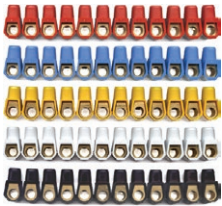

- 450 V~; 2 x 2,5 mm² ÷ 2 x 6 mm²
- termoplast PA
- k dispozícií v rôznych farbách
- počet pólov: 12

1 ROW TERMINAL BLOCKS

- 450V~; 2x2.5mm² ÷ 2x6mm²
- thermoplast PA
- available in different colours
- number of poles: 12

UW15CO	(NS12)	2x2.5mm ²	12P
UW16CO	(NS12)	2x4mm ²	12P
UW17CO	(NS12)	2x6mm ²	12P

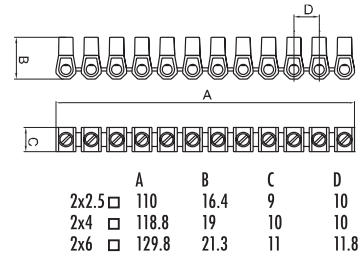

DVOJRADOVÉ SVORKOVNICE PP

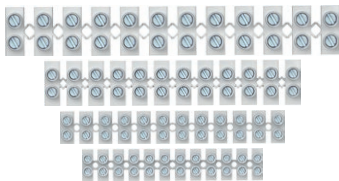

- 450 V~; 1 mm² ÷ 16 mm²
- termoplast polypropylén PP, biely
- pre teploty do 80°C
- počet pólov: 12

2 ROW TERMINAL BLOCKS PP

- 450V~; 1mm² ÷ 16mm²
- thermoplast polypropylene PP, white
- for temperatures up to 80°C
- number of poles: 12

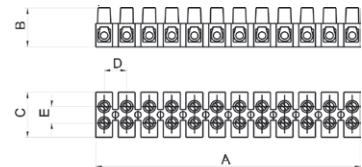

					A	B	C	D	E
UW29WHPP	1.0-4.0mm ²	24 A	450 V		94,9	13	16,6	8,1	6,4
UW30WHPP	1.5-6.0mm ²	32 A	450 V		116,5	14,9	18,9	10	7,3
UW31WHPP	2.5-10mm ²	41 A	450 V		133,8	17,3	23,4	11,5	10
UW32WHPP	4-16mm ²	76 A	450 V		174,5	20,7	25	15	11

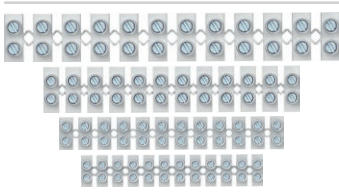

DVOJRADOVÉ SVORKOVNICE PA

- 450 V~; 1 mm² ÷ 16 mm²
- termoplast polyamid PA, biely
- pre teploty do 110°C
- počet pólov: 12

2 ROW TERMINAL BLOCKS PA

- 450V~; 1mm² ÷ 16mm²
- thermoplast polyamide PA, white
- for temperatures up to 110°C
- number of poles: 12



					A	B	C	D	E
UW25WHPA	1.0-4.0mm ²	24 A	450 V		93,6	13,4	16,2	8	6,4
UW26WHPA	1.5-6.0mm ²	32 A	450 V		117	15	18,6	10	7,3
UW27WHPA	2.5-10mm ²	41 A	450 V		132,8	17,3	22,2	11,5	10
UW28WHPA	4-16mm ²	76 A	450 V		173,9	20,8	25,2	15	11

BEZSKRUTKOVÉ SVORKY

- 24 A 450 V ~, termoplast PA, sivý
- počet pólov: 3 ÷ 8
- bezskrútkové upevnenie vodičov 0,5 ÷ 1,5 mm², pre tuhé drôty
- v súlade s normou EN 60998-1

PLUG-IN WIRE CONNECTORS

- 24A 450V~, thermoplast PA, grey
- number of poles: 3÷8
- plug-in contacts 0.5÷1.5mm², for rigide wires
- in accordance with EN 60998-1

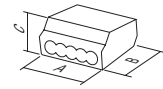

UW40GY	PC153	1.5mm ²	3P	3P	A 12	B 18	C 9
UW41GY	PC155	1.5mm ²	5P	5P	17	18	9
UW42GY	PC158	1.5mm ²	8P	8P	26	18	9

BEZSKRUTKOVÉ SVORKY

- 24 A 450 V ~, termoplast PA, sivý
- počet pólov: 3 ÷ 5
- bezskrútkové upevnenie vodičov 1,5 ÷ 2,5 mm², pre tuhé drôty
- v súlade s normou EN 60998-1

PLUG-IN WIRE CONNECTORS

- 24A 450V~, thermoplast PA, grey
- number of poles: 3÷5
- plug-in contacts 1.5÷2.5mm², for rigide wires
- in accordance with EN 60998-1

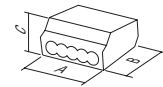

UW45GY	PC253	2.5mm ²	3P	3P	A 14	B 19	C 9
UW46GY	PC254	2.5mm ²	4P	4P	17	19	9
UW47GY	PC255	2.5mm ²	5P	5P	21	19	9

BEZSKRUTKOVÁ SVORKA

- 24 A 450 V ~, termoplast PA, sivý
- počet pólov: 2 (tuhy drôt) + 1 (mäkký drôt)
- bezskrútkové upevnenie vodičov 1,5 ÷ 2,5 mm²
- v súlade s normou EN 60998-1

PLUG-IN WIRE CONNECTOR

- 24A 450V~, thermoplast PA, grey
- number of poles: 2 (rigide wire)+1 (soft wire)
- plug-in contacts 1.5÷2.5mm²
- in accordance with EN 60998-1

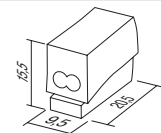



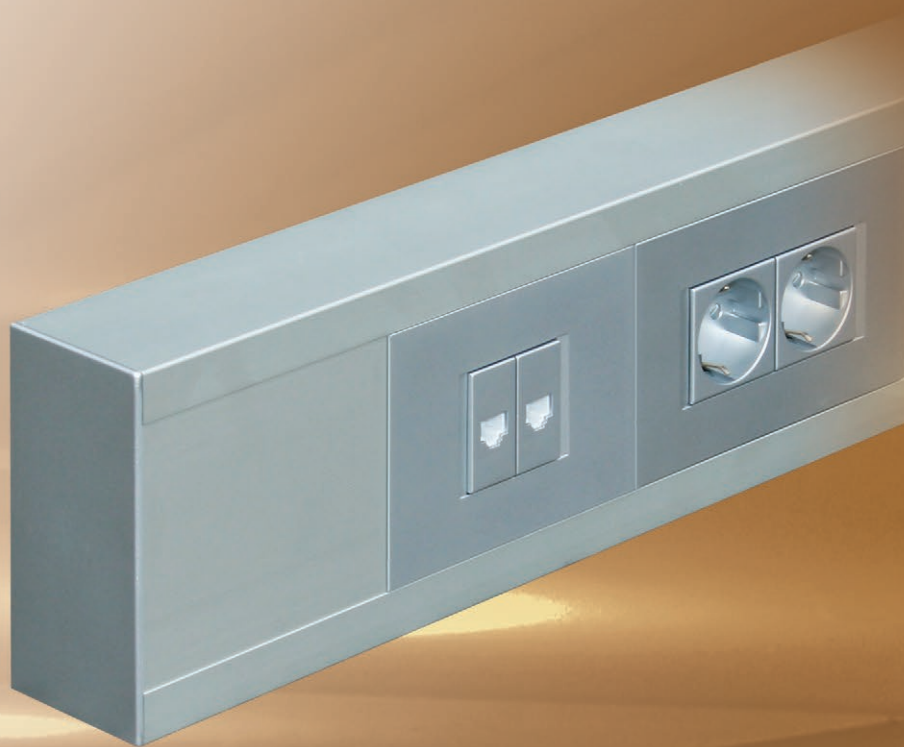

UW50WH	PC302	2.5mm ²	2/1P				
--------	-------	--------------------	------	--	--	--	--

TEM





<p>KRABICE CUBO IP20 AC <i>BOXES CUBO IP20 AC</i></p>		162
<p>KRABICE CUBO IP55 AQ <i>BOXES CUBO IP55 AQ</i></p>		163
<p>SYSTÉM HLINÍKOVÝCH INŠTALAČNÝCH KANÁLOV MA <i>TRUNKING SYSTEM ALUMINIUM MA</i></p>		165
<p>PODLAHOVÉ KRABICE MT <i>FLOOR BOXES MT</i></p>		171
<p>ROZVODNICE MO <i>DISTRIBUTION BOARDS MO</i></p>		173

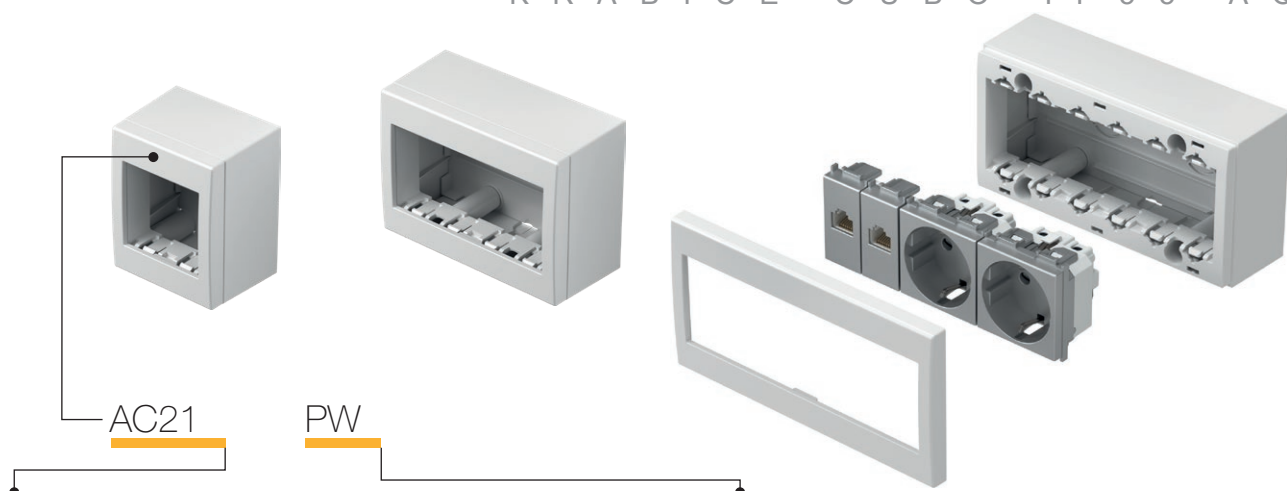

typ type	popis description	technické dáta technical data	veľkosť size	farba colour
AC11	KRABICE PRE POVRCHOVÚ MONTÁŽ S KRYTOM NA ZADNEJ STRANE SURFACE MOUNT BOX WITH BACK SIDE COVER	IP20	1M	<input type="checkbox"/> PW polárna biela polar white <input type="checkbox"/> ES strieborná matná elox silver
AC21	KRABICE PRE POVRCHOVÚ MONTÁŽ S KRYTOM NA ZADNEJ STRANE SURFACE MOUNT BOX WITH BACK SIDE COVER	IP20	2M	<input type="checkbox"/> IW slonová kosť ivory white
AC41	KRABICE PRE POVRCHOVÚ MONTÁŽ S KRYTOM NA ZADNEJ STRANE SURFACE MOUNT BOX WITH BACK SIDE COVER	IP20	4M	

KRABICA NO CUBO S KRYTOM ZADNEJ STRANY IP20 1M



- AC11PW
- AC11ES
- AC11IW

- krabica IP20 1M
- pre povrchovú montáž prvkov
- vhodné pre spínače SM
- v súlade s normou EN 60669-1

BOX NO CUBO WITH BACK SIDE COVER IP20 1M
- box IP20 1M
- for surface mounting of elements
- suitable to SM switches
- in accordance with EN 60669-1



KRABICA NO CUBO S KRYTOM ZADNEJ STRANY IP20 2M



- AC21PW
- AC21ES
- AC21IW

- krabica IP20 2M
- pre povrchovú montáž prvkov
- v súlade s normami EN 60669-1, EN60884-1

BOX NO CUBO WITH BACK SIDE COVER IP20 2M
- box IP20 2M
- for surface mounting of elements
- in accordance with EN 60669-1, EN60884-1



KRABICA NO CUBO S KRYTOM ZADNEJ STRANY IP20 4M



- AC41PW
- AC41ES
- AC41IW

- krabica IP20 4M
- pre povrchovú montáž prvkov
- v súlade s normami EN 60669-1, EN60884-1

BOX NO CUBO WITH BACK SIDE COVER IP20 4M
- box IP20 4M
- for surface mounting of elements
- in accordance with EN 60669-1, EN60884-1



KRABICA NO CUBO S KRYTOM ZADNEJ STRANY IP20 6M



- AC61PW
- AC61ES
- AC61IW

- krabica IP20 6M
- pre povrchovú montáž prvkov
- v súlade s normami EN 60669-1, EN60884-1

BOX NO CUBO WITH BACK SIDE COVER IP20 6M
- box IP20 6M
- for surface mounting of elements
- in accordance with EN 60669-1, EN60884-1

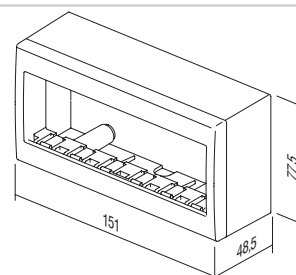
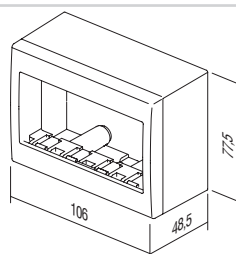
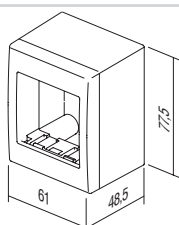
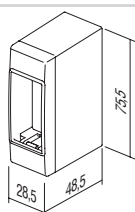

B O X E S C U B O I P 5 5 A Q

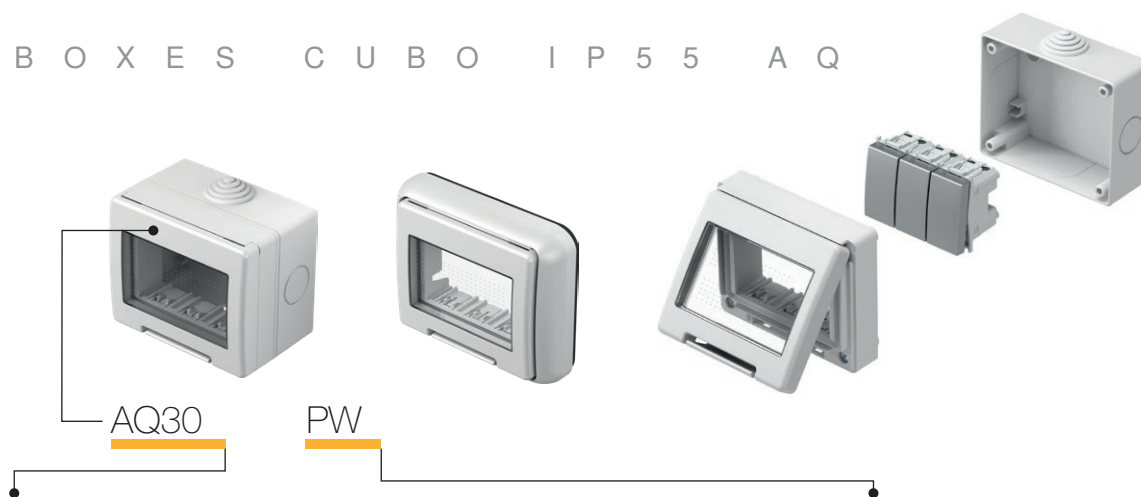

AQ30

PW

typ type	popis description	technické dáta technical data	veľkosť size	farba colour
AQ20	KRABICA URČENÁ PRE POVRCHOVÚ MONTÁŽ DO EXTERIÉRU IP55 <i>OUTDOOR SURFACE MOUNT BOX</i>		2M	<input type="checkbox"/> PW polárna biela <i>polar white</i>
AQ22	KRABICA URČENÁ PRE POVRCHOVÚ MONTÁŽ DO EXTERIÉRU IP55 <i>OUTDOOR SURFACE MOUNT BOX</i>		2x2M	<input checked="" type="checkbox"/> GY sivá <i>grey</i>
AQ30	KRABICA URČENÁ PRE POVRCHOVÚ MONTÁŽ DO EXTERIÉRU IP55 <i>OUTDOOR SURFACE MOUNT BOX</i>		3M	
AQ31	KRABICA URČENÁ PRE POVRCHOVÚ MONTÁŽ DO EXTERIÉRU IP55 <i>OUTDOOR SURFACE MOUNT BOX</i>		3M	

KRABICA NO CUBO IP55 2M



- AQ20PW
 AQ20GY

- krabica IP55 2M
- pre povrchovú montáž
- IP55 pre použitie vo vlhkých oblastiach
- v súlade s normami CEI 23-48, EN 60670

BOX NO CUBO IP55 2M

- box IP55 2M
- for surface mounting
- IP55 for usage in humid areas
- in accordance with CEI 23-48, EN 60670



KRABICA NO CUBO IP55 2x2M



- AQ22PW
 AQ22GY

- krabica IP55 2 x 2M
- pre povrchovú montáž
- IP55 pre použitie vo vlhkých oblastiach
- v súlade s normami CEI 23-48, EN 60670

BOX NO CUBO IP55 2x2M

- box IP55 2x2M
- for surface mounting
- IP55 for usage in humid areas
- in accordance with CEI 23-48, EN 60670



KRABICA NO CUBO IP55 3M



- AQ30PW
 AQ30GY

- krabica IP55 3M
- pre povrchovú montáž
- IP55 pre použitie vo vlhkých oblastiach
- v súlade s normami CEI 23-48, EN 60670

BOX NO CUBO IP55 3M

- box IP55 3M
- for surface mounting
- IP55 for usage in humid areas
- in accordance with CEI 23-48, EN 60670



KRABICA PO CUBO IP55 3M



- AQ31PW
 AQ31GY

- krabica IP55 3M
- na zapustenú montáž
- IP55 pre použitie vo vlhkých oblastiach
- v súlade s normami CEI 23-48, EN 60670

BOX PO CUBO IP55 3M

- box IP55 3M
- for flush mounting
- IP55 for usage in humid areas
- in accordance with CEI 23-48, EN 60670





□ AQ21PW

KRABICA PO CUBO IP55 2M

- krabica IP55 2M
- môžete ju kombinovať so všetkými funkčnými elementami Modul
- na zapustenú montáž
- IP55 pre montáž do vlhkých priestorov
- v súlade s normami CEI 23-48, EN 60670

BOX PO CUBO IP55 2M

- box IP55 2M
- can be combined with all Modul functional elements
- for flush mounting
- IP55 for usage in humid areas
- in accordance with CEI 23-48, EN 60670

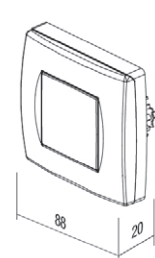
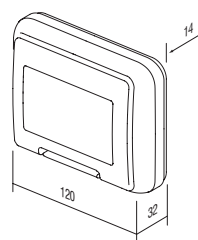
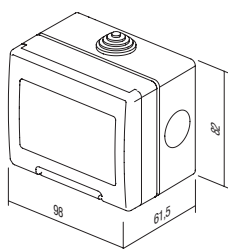
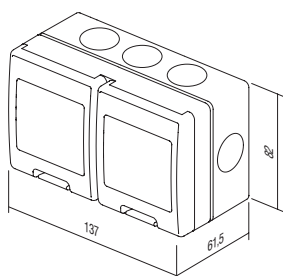
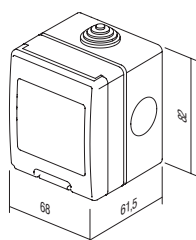

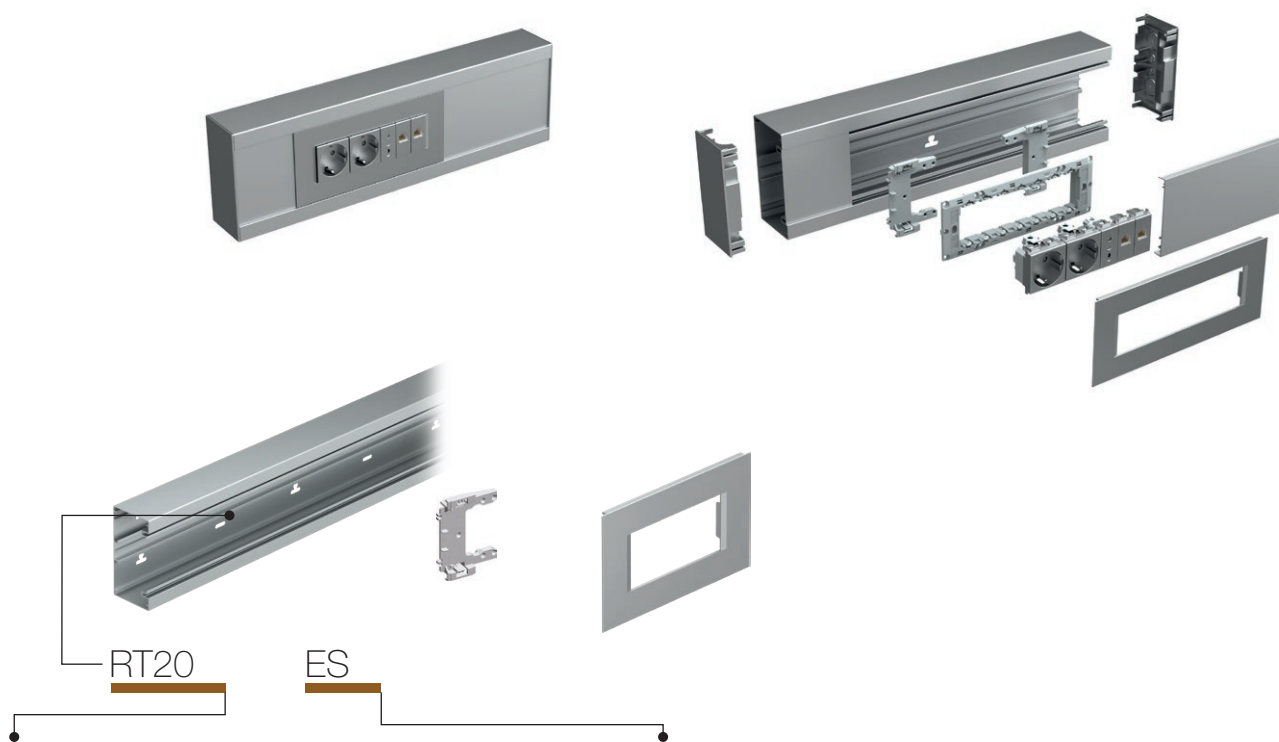

typ type	popis description	veľkosť size	farba colour
RT10	ADAPTÉR MA 92 ADAPTER MA 92	/	■ ES eloxová strieborná – matná elox silver-mat
RT12	RÁMIK MA 92 COVER PLATE MA 92	2/3M	□ PW biela - matná (RAL 9016) white-mat
RT14	RÁMIK MA 92 COVER PLATE MA 92	4M	
⋮	⋮	⋮	

ADAPTÉR MA 92



RT10

- adaptér pre upevnenie montážnych rámov 2/3M, 4M alebo 7M na kanál MA bez krabice
- každý montážny rám vyžaduje dva adaptéry
- v súlade s normou EN 50085-1

ADAPTER MA 92

- adapter for fixing mounting frames 2/3M, 4M or 7M on MA trunking without box
- each mounting frame needs two adapters
- in accordance with EN 50085-1

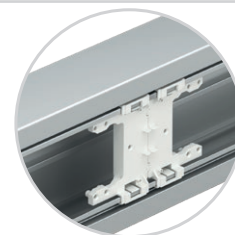

RÁMIK MA 92 2/3M



■ RT12ES
□ RT12PW

- dekoratívny rámik MA 2/3M
- v súlade s normou EN 50085-1

COVER PLATE MA 92 2/3M

- decorative cover plate MA 2/3M
- in accordance with EN 50085-1

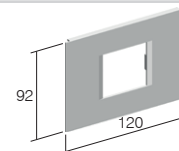

RÁMIK MA 92 4M



■ RT14ES
□ RT14PW

- dekoratívny rámik MA 4M
- v súlade s normou EN 50085-1

COVER PLATE MA 92 4M

- decorative cover plate MA 4M
- in accordance with EN 50085-1

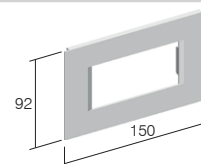

RÁMIK MA 92 7M



■ RT17ES
□ RT17PW

- dekoratívny rámik MA 7M
- v súlade s normou EN 50085-1

COVER PLATE MA 92 7M

- decorative cover plate MA 7M
- in accordance with EN 50085-1

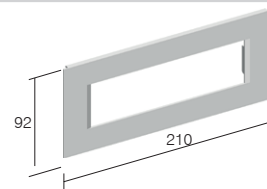

ZÁKLADNÝ PROFIL MA 130x65



- RT20ES
- RT20PW

- základ kanála z extrudovaného hliníka
 - výška 130 mm, dĺžka 2 m
 - tvar lišty 35 mm na dne – DIN
 - v súlade s normou EN 50085-1

TRUNKING BASE MA 130x65

- trunking base from extruded aluminium
 - height 130mm, length 2m
 - DIN - rail 35mm shape on bottom
 - in accordance with EN 50085-1

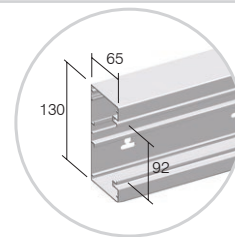

ZÁKLADNÝ PROFIL MA 165x65



- RT21ES
- RT21PW

- základ kanála z extrudovaného hliníka
 - výška 165 mm, dĺžka 2 m
 - tvar lišty 35 mm na dne – DIN
 - v súlade s normou EN 50085-1

TRUNKING BASE MA 165x65

- trunking base from extruded aluminium
 - height 165mm, length 2m
 - DIN - rail 35mm shape on bottom
 - in accordance with EN 50085-1

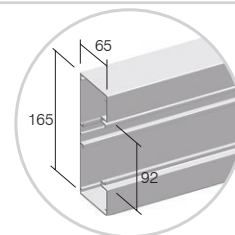

PREDNÝ KRYT MA 92



- RT25ES
- RT25PW

- predný kryt z extrudovaného hliníka
 - výška 92 mm, dĺžka 2 m
 - v súlade s normou EN 50085-1

FRONT COVER MA 92

- front cover from extruded aluminium
 - height 92mm, length 2m
 - in accordance with EN 50085-1

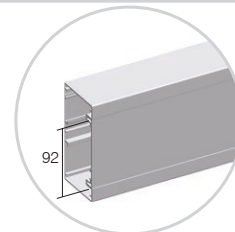

PRIEHRADKA MA 43



RT30

- priehradka kanála z extrudovaného polyméru
 - hĺbka 43 mm, dĺžka 2 m
 - v súlade s normou EN 50085-1

CABLE SHELF MA 43

- cable shelf from extruded polymer
 - depth 43mm, length 2m
 - in accordance with EN 50085-1

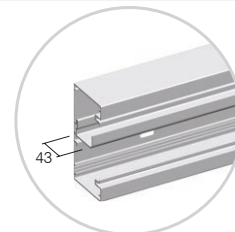

PRIEHRADKA MA 43 AL



RT31

- priehradka kanála z extrudovaného hliníka
 - hĺbka 43 mm, dĺžka 2 m
 - v súlade s normou EN 50085-1

CABLE SHELF MA 43 AL

- cable shelf from extruded aluminium
 - depth 43mm, length 2m
 - in accordance with EN 50085-1

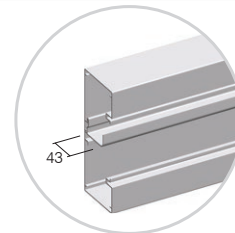

PRIEHRADKA MA 43 AL DVOJITÁ











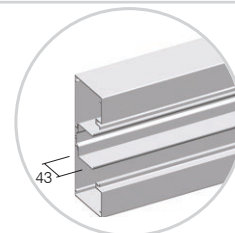

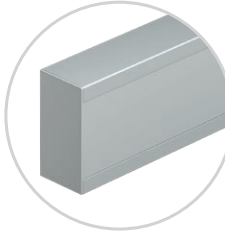

RT32

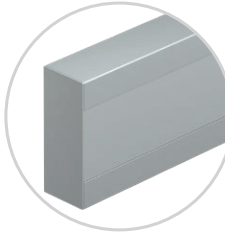
- dvojitá priehradka kanála z extrudovaného hliníka
 - hĺbka 43 mm, dĺžka 2 m
 - v súlade s normou EN 50085-1

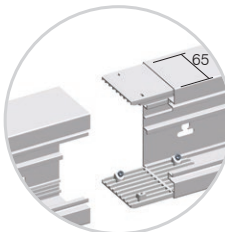
CABLE SHELF MA 43 AL DOUBLE

- double cable shelf from extruded aluminium
 - depth 43mm, length 2m
 - in accordance with EN 50085-1

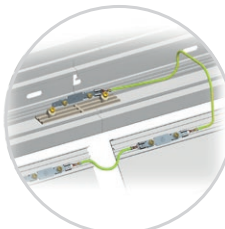

	<ul style="list-style-type: none"> ■ RT35ES □ RT35PW 	<p>KONCOVÝ PRVOK MA 130x65</p> <ul style="list-style-type: none"> - koncový prvok z polyméru - výška 130 mm - v súlade s normou EN 50085-1 <p><i>STOP END MA 130x65</i></p> <ul style="list-style-type: none"> - stop end element from polymer - height 130mm - in accordance with EN 50085-1 	
	<ul style="list-style-type: none"> ■ RT36ES □ RT36PW 	<p>KONCOVÝ PRVOK MA 165x65</p> <ul style="list-style-type: none"> - koncový prvok z kovu - výška 165 mm - v súlade s normou EN 50085-1 <p><i>STOP END MA 165x65</i></p> <ul style="list-style-type: none"> - stop end element from metal - height 165mm - in accordance with EN 50085-1 	
	RT38	<p>SÚPRAVA SPOJOVACÍCH PRVKOV MA 65</p> <ul style="list-style-type: none"> - spojovací prvok z polyméru - súprava obsahuje dva kusy a skrutky - v súlade s normou EN 50085-1 <p><i>SET JOINING PIECE MA 65</i></p> <ul style="list-style-type: none"> - joining piece from polymer - set contains two pieces and screws - in accordance with EN 50085-1 	
	<ul style="list-style-type: none"> ■ RT40ES □ RT40PW 	<p>UNIVERZÁLNY ROH MA 130x65</p> <ul style="list-style-type: none"> - univerzálny rohový prvok - výška 130 mm - v súlade s normou EN 50085-1 <p><i>UNIVERSAL CORNER MA 130x65</i></p> <ul style="list-style-type: none"> - universal corner element - height 130mm - in accordance with EN 50085-1 	
	<ul style="list-style-type: none"> ■ RT41ES □ RT41PW 	<p>UNIVERZÁLNY ROH MA 165x65</p> <ul style="list-style-type: none"> - univerzálny rohový prvok - výška 165 mm - v súlade s normou EN 50085-1 <p><i>UNIVERSAL CORNER MA 165x65</i></p> <ul style="list-style-type: none"> - universal corner element - height 165mm - in accordance with EN 50085-1 	
	RT42	<p>UZEMŇOVACIA SVORKA MA 2x A6.3</p> <ul style="list-style-type: none"> - uzemňovací prvok pre uzemnenie spodného diela kanála a predného krytu - v súlade s normou EN 50085-1 <p><i>EARTHING PIECE MA 2x A6.3</i></p> <ul style="list-style-type: none"> - earthing piece for earthing of trunking base and front cover - in accordance with EN 50085-1 	

PRVOK V TVARE "L" MA 130x65



- RT43ES
- RT43PW

- univerzálny ohnutý prvok do tvaru L z hliníka
- výška 130 mm, dĺžka 400 mm
- v súlade s normou EN 50085-1

L-BEND MA 130x65

- universal L bend element from aluminium
- height 130mm, length 400mm
- in accordance with EN 50085-1

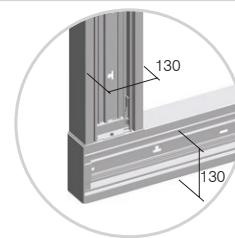

PRVOK V TVARE "L" MA 165x65



- RT44ES
- RT44PW

- univerzálny ohnutý prvok do tvaru L z hliníka
- výška 165 mm, dĺžka 400 mm
- pripojenie na MA 130 x 65
- v súlade s normou EN 50085-1

L-BEND MA 165x65

- universal L bend element from aluminium
- height 165mm, length 400mm
- connection on MA 130x65
- in accordance with EN 50085-1

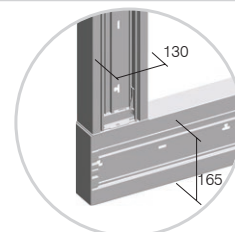

ROZDEL'OVACÍ PRVOK V TVARE "T" MA 130x65



- RT45ES
- RT45PW

- univerzálny ohnutý prvok do tvaru T z hliníka
- výška 130 mm, dĺžka 400 mm
- v súlade s normou EN 50085-1

T-BEND MA 130x65

- universal T bend element from aluminium
- height 130mm, length 400mm
- in accordance with EN 50085-1

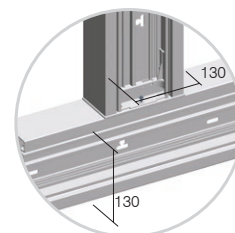

ROZDEL'OVACÍ PRVOK V TVARE "T" MA 165x65

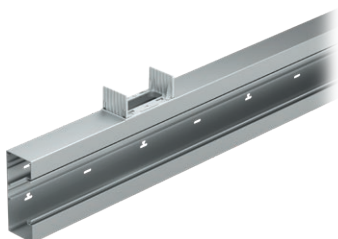

- RT46ES
- RT46PW

- univerzálny ohnutý prvok do tvaru T z hliníka
- výška 165 mm, dĺžka 400 mm
- pripojenie na MA 130 x 65
- v súlade s normou EN 50085-1

T-BEND MA 165x65

- universal T bend element from aluminium
- height 165mm, length 400mm
- connection on MA 130x65
- in accordance with EN 50085-1

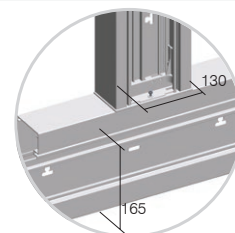

Inštalácia MA je založená na modulárnom systéme, ktorý zabezpečuje kombinácie 2M, 4M alebo 7M prvkov

MA trunking is based on modular system making 2M, 4M or 7M combinations of elements

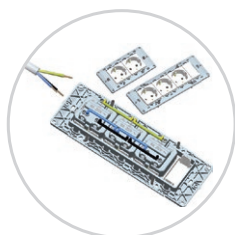

V Module poskytujeme špeciálne prvky pre rýchlu inštaláciu

In Modul we provide special elements for quick installation

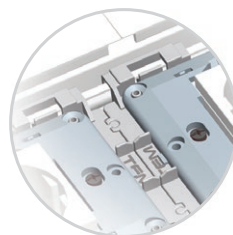

Pomocou adaptéra MA je zabezpečené presné umiestnenie bez ďalšieho úsilia.

With Adapter MA exact positioning without extra effort is provided

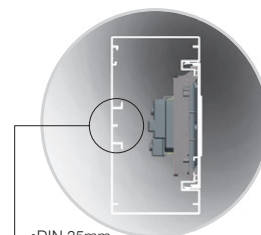

Montáž bez krabice znamená väčší priestor pre káble na DIN lištu tvaru EN-60715

Mounted without box means more space for cables, DIN-rail base shape EN-60715

TRUNKING SYSTEM ALUMINIUM



UPEVŇOVACIA ZÁKLADŇA MA JEDNODUCHÁ 130x65



- RT50ES
- RT50PW

- upevňovacia podstava pre upevnenie spodného diela kanála MA130
do podlahy alebo stropu miestnosti
- v súlade s normou EN 50085-1

FIXING PLATE MA SINGLE 130x65

- fixing plate for fixing trunking base MA130 on the floor
and/or on the ceiling
- in accordance with EN 50085-1



- RT51ES
- RT51PW

UPEVŇOVACIA ZÁKLADŇA MA DVOJITÁ 130x65

- upevňovacia podstava pre upevnenie dvoch kanálov MA130
do podlahy alebo stropu miestnosti
- v súlade s normou EN 50085-1

FIXING PLATE MA DOUBLE 130x65

- fixing plate for fixing two trunking bases MA130 on the
floor and/or on the ceiling
- in accordance with EN 50085-1



STĽPIK MA 130x65x500

- RT52ES
- RT52PW

- servisný stĺpik MA
- výška 500 mm
- montážny rám 7M je súčasťou dodávky
- v súlade s normou EN 50085-1

SERVICE POST MA 130x65x500

- service post MA
- height 500mm
- mounting frame 7M included
- in accordance with EN 50085-1



STĽPIK MA DVOJITÝ 130x130x500

- RT53ES
- RT53PW

- servisný stĺpik MA dvojitý
- výška 500 mm
- montážne rámy 7M sú súčasťou dodávky
- v súlade s normou EN 50085-1

SERVICE POST MA DOUBLE 130x130x500

- service post MA double
- height 500mm
- mounting frames 7M included
- in accordance with EN 50085-1

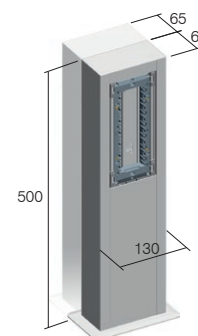

Cable intersection mm ²	Použitelný prierez káblov Cable cross-section (mm ²)				
	1 vodič/ 1 wire	2 vodiče/ 2 wires	3 vodiče/ 3 wires	4 vodiče/ 4 wires	5 vodičov/ 5 wires
1,5	44	111	121	144	169
2,5	49	133	157	169	211
4	58	169	183	211	256
6	68	196	225	256	307

Kanál / Trunk	Kapacita kanála / Trunk capacity			
	MA 130x65 prázdny / empty	MA 130x65 so spínačmi a zásuvkami rady Modul / with Modul switches and sockets	MA 165x65 prázdny / empty	MA 130x65 so spínačmi a zásuvkami rady Modul / with Modul switches and sockets
kapacita capacity	7600 mm ²	5500 mm ²	9900 mm ²	7800 mm ²
max ø	54 mm	2x42 mm	54 mm	2x42 mm

PODLAHOVÉ KRABICE MT



RB33

DISTRIBÚCIA

typ type	popis description	technické dáta technical data
RB30	PODLAHOVÁ KRABICA FLOOR BOX	MT 7
RB31	PODLOŽKA PODLAHOVEJ KRABICE FLOOR BOX FLANGE	MT 7
RB33	PODLAHOVÁ KRABICA FLOOR BOX	MT 14
⋮	⋮	⋮

	RB30	RB33	RB36	RB40	RB43	RB46
a	170	260	350	170	260	350
b	260	260	260	260	260	260
X	140	230	320	140	230	320
Y	230	230	230	230	230	230

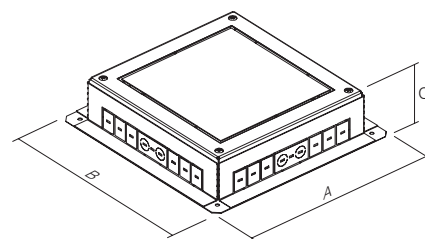
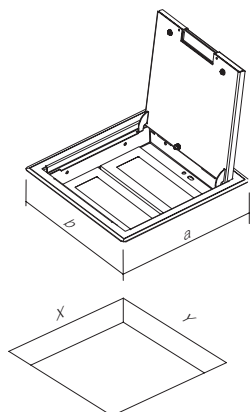

	RB31	RB34	RB37	RB41	RB44	RB47
A	250	340	430	250	340	430
B	340	340	340	340	340	340
C	95-125	95-125	95-125	125-150	125-150	125-150

PODLAHOVÁ KRABICA MT 7



RB30

- podlahová krabica MT 7
- kovová, strieborná RAL 9006
- súčasťou je montážny rám MODUL 7M
- montážne rozmery 140 x 230 mm, hĺbka min. 95 mm
- hrúbka podlahového obkladu až do 10 mm
- v súlade s normami EN 50085-1 a STN EN 50085-2-2

FLOOR BOX MT 7

- floor box MT 7
- metal, colour silver RAL 9006
- mounting frame MODUL 7M included
- mounting dimensions 140x230mm, depth min 95mm
- floor lining thickness up to 10mm
- in accordance with EN 50085-1 and EN 50085-2-2

PODLAHOVÁ KRABICA MT 7 H = 88 mm



RB40

- podlahová krabica MT 7
- kovová, strieborná RAL 9006
- súčasťou je montážny rám MODUL 7M
- montážne rozmery 140 x 230 mm, hĺbka min. 120 mm
- hrúbka podlahového obkladu až do 10 mm
- v súlade s normami EN 50085-1 a STN EN 50085-2-2

FLOOR BOX MT 7 H=88mm

- floor box MT 7
- metal, colour silver RAL 9006
- mounting frame MODUL 7M included
- mounting dimensions 140x230mm, depth min 120mm
- floor lining thickness up to 10mm
- in accordance with EN 50085-1 and EN 50085-2-2

PODLOŽKA PODLAHOVEJ KRABICE MT 7

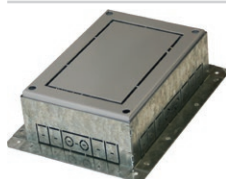

RB31

- príruha podlahovej krabice pre kryt krabice MT 7
- kovová, pozinkovaná
- na montáž do podlahy alebo dvojitej podlahy
- nastaviteľná výška 95 až 125 mm
- v súlade s normami EN 50085-1 a STN EN 50085-2-2

FLOOR BOX FLANGE MT 7

- floor box flange for box cover MT 7
- metal, galvanized
- for installation in a floor or double floor
- adjustable height 95-125mm
- in accordance with EN 50085-1 and EN 50085-2-2

PODLOŽKA PODLAHOVEJ KRABICE MT 7 H = 88 mm

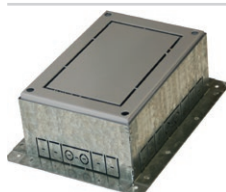

RB41

- príruha podlahovej krabice pre kryt krabice MT 7 H = 88 mm
- kovová, pozinkovaná
- na montáž do podlahy alebo dvojitej podlahy
- nastaviteľná výška 125 – 150 mm
- v súlade s normami EN 50085-1 a STN EN 50085-2-2

FLOOR BOX FLANGE MT 7 H=88mm

- floor box flange for box cover MT 7 H=88mm
- metal, galvanized
- for installation in a floor or double floor
- adjustable height 125-150mm
- in accordance with EN 50085-1 and EN 50085-2-2

PODLAHOVÁ KRABICA MT 14



RB33

- podlahová krabica MT 14
- kovová, strieborná RAL 9006
- súčasťou sú montážne rámy MODUL 2x7M
- montážne rozmery sú 230 x 230 mm, hĺbka min. 95 mm
- hrúbka podlahového obkladu až do 10 mm
- v súlade s normami EN 50085-1 a STN EN 50085-2-2

FLOOR BOX MT 14

- floor box MT 14
- metal, colour silver RAL 9006
- mounting frame MODUL 2x7M included
- mounting dimensions 230x230mm, depth min 95mm
- floor lining thickness up to 10mm
- in accordance with EN 50085-1 and EN 50085-2-2

PODLAHOVÁ KRABICA MT 14 H = 88 mm



RB43

- podlahová krabica MT 14
- kovová, strieborná RAL 9006
- súčasťou sú montážne rámy MODUL 2x7M
- montážne rozmery sú 230 x 230 mm, hĺbka min. 120mm
- hrúbka podlahového obkladu až 10 mm
- v súlade s normami EN 50085-1 a STN EN 50085-2-2

FLOOR BOX MT 14 H=88mm

- floor box MT 14
- metal, colour silver RAL 9006
- mounting frames MODUL 2x7M included
- mounting dimensions 230x230mm, depth min 120mm
- floor lining thickness up to 10mm
- in accordance with EN 50085-1 and EN 50085-2-2

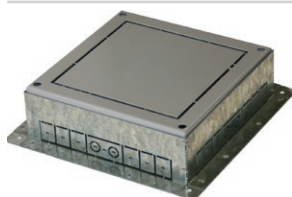

RB34

PODLOŽKA PODLAHOVEJ KRABICE MT 14

- podložka podlahovej krabice pre kryt krabice MT 14
- kovová, pozinkovaná
- na montáž do podlahy alebo dvojitej podlahy
- nastaviteľná výška 95 až 125 mm
- v súlade s normami EN 50085-1 a STN EN 50085-2-2

FLOOR BOX FLANGE MT 14

- floor box flange for box cover MT 14
- metal, galvanized
- for installation in a floor or double floor
- adjustable height 95-125mm
- in accordance with EN 50085-1 and EN 50085-2-2

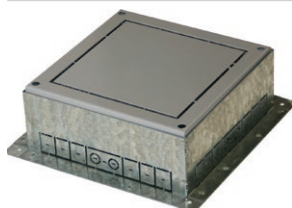

RB44

PODLOŽKA PODLAHOVEJ KRABICE MT 14 H = 88 mm

- podložka podlahovej krabice pre kryt krabice MT 14 H = 88 mm
- kovová, pozinkovaná
- na montáž do podlahy alebo dvojitej podlahy
- nastaviteľná výška 125 – 150 mm
- v súlade s normami EN 50085-1 a STN EN 50085-2-2

FLOOR BOX FLANGE MT 14 H=88mm

- floor box flange for box cover MT 14 H=88mm
- metal, galvanized
- for installation in a floor or double floor
- adjustable height 125-150mm
- in accordance with EN 50085-1 and EN 50085-2-2



RB36

PODLAHOVÁ KRABICA MT 21

- podlahová krabica MT 21
- kovová, strieborná RAL 9006
- súčasťou sú montážne rámy MODUL 3 x 7M
- montážne rozmery sú 320 x 230 mm, hĺbka min. 95 mm
- hrúbka podlahového obkladu až 10 mm
- v súlade s normami EN 50085-1 a STN EN 50085-2-2

FLOOR BOX MT 21

- floor box MT 21
- metal, colour silver RAL 9006
- mounting frames MODUL 3x7M included
- mounting dimensions 320x230mm, depth min 95mm
- floor lining thickness up to 10mm
- in accordance with EN 50085-1 and EN 50085-2-2



RB46

PODLAHOVÁ KRABICA MT 21 H = 88 mm

- podlahová krabica MT 21
- kovová, strieborná RAL 9006
- súčasťou sú montážne rámy MODUL 3 x 7M
- montážne rozmery sú 320 x 230 mm, hĺbka min. 120 mm
- hrúbka podlahového obkladu až 10 mm
- v súlade s normami EN 50085-1 a STN EN 50085-2-2

FLOOR BOX MT 21 H=88mm

- floor box MT 21
- metal, colour silver RAL 9006
- mounting frames MODUL 3x7M included
- mounting dimensions 320x230mm, depth min 120mm
- floor lining thickness up to 10mm
- in accordance with EN 50085-1 and EN 50085-2-2



RB37

PODLOŽKA PODLAHOVEJ KRABICE MT 21

- podložka podlahovej krabice pre kryt krabice MT 21
- kovová, pozinkovaná
- na montáž do podlahy alebo dvojitej podlahy
- nastaviteľná výška 95 až 125 mm
- v súlade s normami EN 50085-1 a STN EN 50085-2-2

FLOOR BOX FLANGE MT 21

- floor box flange for box cover MT 21
- metal, galvanized
- for installation in a floor or double floor
- adjustable height 95-125mm
- in accordance with EN 50085-1 and EN 50085-2-2



RB47

PODLOŽKA PODLAHOVEJ KRABICE MT 21 H = 88 mm

- podložka podlahovej krabice pre kryt krabice MT 21 H = 88 mm
- kovová, pozinkovaná
- na montáž do podlahy alebo dvojitej podlahy
- nastaviteľná výška 125 – 150 mm
- v súlade s normami EN 50085-1 a STN EN 50085-2-2

FLOOR BOX FLANGE MT 21 H=88mm

- floor box flange for box cover MT 21 H=88mm
- metal, galvanized
- for installation in a floor or double floor
- adjustable height 125-150mm
- in accordance with EN 50085-1 and EN 50085-2-2

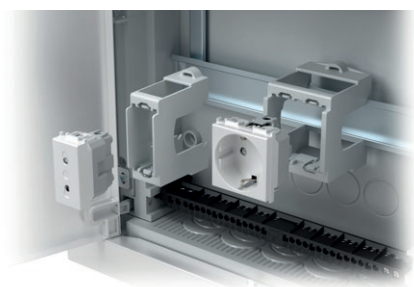

RB20

typ type	popis description	technické dáta technical data
RB10	ADAPTÉR NA DIN LIŠTU ADAPTER FOR DIN RAIL	35mm 1M
RB11	ADAPTÉR NA DIN LIŠTU ADAPTER FOR DIN RAIL	35mm 2M
RB20	ROZVODNÁ SKRINKA DISTRIBUTION BOX	MO 12+2
⋮	⋮	⋮

ADAPTÉR NA DIN LIŠTU 35 mm 1M



RB10

- adaptér MODUL 1M
- montáž na DIN lištu 35mm
- v súlade s normou EN 50022

ADAPTER FOR DIN RAIL 35mm 1M

- adapter MODUL 1M
- for DIN rail 35mm
- in accordance with EN 50022

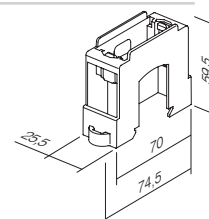

ADAPTÉR NA DIN LIŠTU 35 mm 2M



RB11

- adaptér MODUL 2M
- montáž na DIN lištu 35mm
- v súlade s normou EN 50022

ADAPTER FOR DIN RAIL 35mm 2M

- adapter MODUL 2M
- for DIN rail 35mm
- in accordance with EN 50022

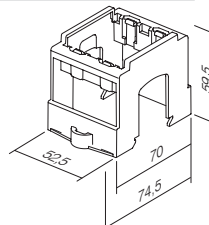

ROZVODNÁ SKRINKA MO 12 + 2



RB20

- rozvodná skrinka MO jednoradová 12 + 2MU
- 400 V ~, trieda II, IP40
- kovové dvierka a rám, farba biela RAL 9016
- súčasťou sú aj uzemňovacie a nulové svorky
- univerzálna inštalácia do steny
- v súlade s normami EN 60670-1 a IEC 60670-24

DISTRIBUTION BOX MO 12+2

- distribution box MO single row 12+2MU
- 400V~, Class II, IP40
- metal leveling frame and door, colour white RAL 9016
- neutral and earth conductor terminals enclosed
- for brick wall mounting
- in accordance with EN 60670-1 and IEC 60670-24

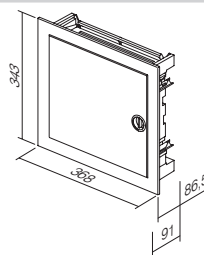

RB20V0

- s montážou na dutú stenu
- for hollow wall mounting

ROZVODNÁ SKRINKA MO 24 + 4



RB21

- rozvodná skrinka MO dvojradová 24 + 4MU
- 400 V ~, trieda II, IP40
- kovové dvierka a rám, farba biela RAL 9016
- súčasťou sú aj uzemňovacie a nulové svorky
- univerzálna inštalácia do steny
- v súlade s normami EN 60670-1 a IEC 60670-24

DISTRIBUTION BOX MO 24+4

- distribution box MO double row 24+4MU
- 400V~, Class II, IP40
- metal leveling frame and door, colour white RAL 9016
- neutral and earth conductor terminals enclosed
- for brick wall mounting
- in accordance with EN 60670-1 and IEC 60670-24

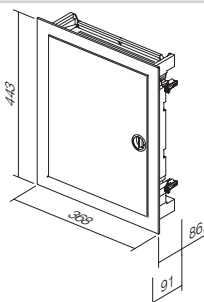

RB21V0

- s montážou na dutú stenu
- for hollow wall mounting

ROZVODNÁ SKRINKA MO 36 + 6



RB22

- rozvodná skrinka MO trojradová 36 + 6 MU
- 400 V ~, trieda II, IP40
- kovové dvierka a rám, farba biela RAL 9016
- súčasťou sú aj uzemňovacie a nulové svorky
- univerzálna inštalácia do steny
- v súlade s normami EN 60670-1 a IEC 60670-24

DISTRIBUTION BOX MO 36+6

- distribution box MO triple row 36+6 MU
- 400V~, Class II, IP40
- metal leveling frame and door, colour white RAL 9016
- neutral and earth conductor terminals enclosed
- for brick wall mounting
- in accordance with EN 60670-1 and IEC 60670-24

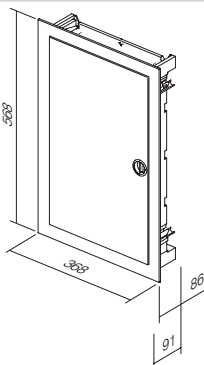

RB22V0

- s montážou na dutú stenu
- for hollow wall mounting

ROZVODNÁ SKRINKA MO 48 + 8



RB23

- rozvodná skrinka MO štvorradová 48 + 8 MU
- 400 V ~, trieda II, IP40
- kovové dvierka a rám, farba biela RAL 9016
- súčasťou sú aj uzemňovacie a nulové svorky
- univerzálna inštalácia do steny
- v súlade s normami EN 60670-1 a IEC 60670-24

DISTRIBUTION BOX MO 48+8

- distribution box MO quad row 48+8 MU
- 400V~, Class II, IP40
- metal leveling frame and door, colour white RAL 9016
- neutral and earth conductor terminals enclosed
- for brick wall mounting
- in accordance with EN 60670-1 and IEC 60670-24

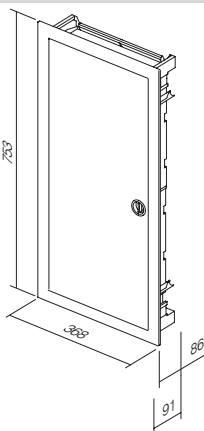

RB23V0

- s montážou na dutú stenu
- for hollow wall mounting

DISTRIBÚCIA

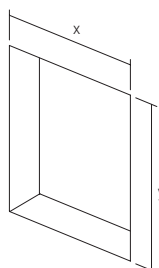

	RB20 RB20V0	RB21 RB21V0	RB22 RB22V0	RB23 RB23V0
x	314	314	314	314
y	314	414	539	724



ekonomik[®]



Planned for excellence
Style is essential



ERGO

METAL

SOFT

Neutrálny, kompaktný a elegantný dizajn sa prispôsobí každému obytnému alebo pracovnému priestoru. V interiéroch sa nevyníma, ale harmonicky s ním ladí.

A neutral, compact, elegant design is adjustable to every working or living area. It does not stick out from the interior, but rather harmonically fits into it.





Navrhnuté pre dokonalosť Podstatný je štýl



Čistá línia je mierne zaoblená a premyslená ergonómia je navrhnutá osobitne pre vás.

A pure line is slightly curved - well considered ergonomics especially for you.



Môžete si vybrať medzi lesklými, reflexnými povrchmi a moderným, kovovým vzhľadom.

You can choose between shiny reflective surfaces and modern metallic look.



Jemnosť tvarov si nájde svoje miesto v moderných, ako aj v klasických interiéroch.

The softness of the form will find its place in modern as well as in classic interiors.

HARMONY

REFLEX

UV PROTECT

Túžby vedia byť rozličné, práve preto sme venovali veľkú pozornosť výberu možností, ktoré vám poskytnú správnu odpoveď. Neutrálna paleta farieb iba doplní atmosféru miestnosti – nebude vás obmedzovať.

Desires can be very different. Therefore we have carefully selected possibilities for you, which can offer you the right answer. A neutral palette of colours will only complement your ambient - it will not restrict it.

Press and the world will spring to life
Colourful landscape between walls



Reflexné pocity vám navodia lesklé polymérové materiály v bielej a slonovinovej farbe.

Shiny polymer materials in white and beige colours enable reflective mood.



Dekoratívny kovový vzhľad je súčasne moderný aj neutrálny.

Selected decorative metallic coat is at the same time modern and neutral.

Stlačte a svet ožije

Farebná krajina medzi stenami



Pre všetkých, ktorí sa chcú pohrať s pastelovými farbami, predstavuje Ekonomik Color riešenie.

For those who want to play with pastel colours Ekonomik Color represents a perfect solution.



Robustnosť a vysoká odolnosť voči vonkajším vplyvom (UV) je zabezpečená prostredníctvom duroplastických materiálov (Color).

Robustness and high resistance to external effects (UV) are secured by duroplastic materials (Color line).



VERTICAL

HORIZONTAL

SAVE SPACE



Kombinácie znamenajú úsporu miesta na stene. Keď máte málo miesta, správnym rozhodnutím je zvislá kombinácia.

With combining you save space on the wall. When faced with a limited space, »vertically« is the right decision.



Kombinujte podľa svojho želania.
Combine as you please.



Viditeľné prvky sa jednoducho demontujú. Vďační vám budú aj maliari.

Visible elements can be easily taken apart. Painters will be grateful to you.



Prolonge your day with a touch
Simplified living

Dotykom si predĺžte deň Zjednodušené bývanie

Rad Ekonomik je riešenie pre systém štandardných okrúhlych krabíc. Pomocou nich môžete navrhnúť jednoduché a tiež náročnejšie inštalácie, novostavby aj adaptácie. Systém sa vyznačuje bezskrutkovými kontaktmi, ktoré vám ušetria čas pri inštalácii jednotlivých prvkov.

Ekonomik is a solution for the system of standardized round installations boxes. It can be used for simple as well as more demanding installations, new buildings and adaptations. The system is characterised by plug-in contacts which save time during installation of elements.

Dobrý pocit v bezpečí

Absolútna dôvera v dobrú konštrukciu

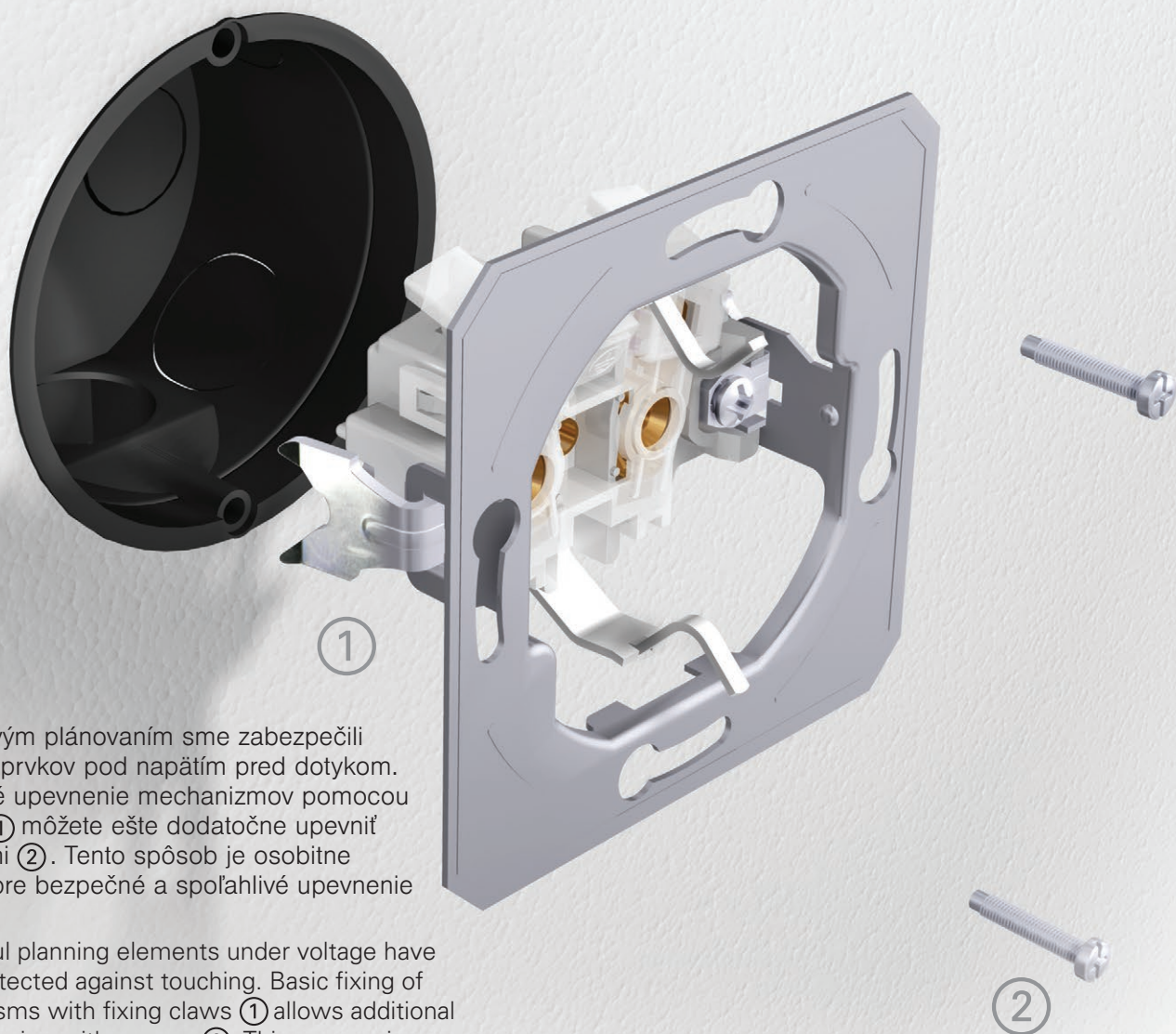

Starostlivým plánovaním sme zabezpečili ochranu prvkov pod napätím pred dotykom. Základné upevnenie mechanizmov pomocou svoriek ① môžete ešte dodatočne upevniť skrutkami ②. Tento spôsob je osobitne vhodný pre bezpečné a spoľahlivé upevnenie zásuvky.

By careful planning elements under voltage have been protected against touching. Basic fixing of mechanisms with fixing claws ① allows additional strengthening with screws ②. This manner is especially appropriate for safe and reliable fixing of sockets.

SIMPLE

FAST

FLEX

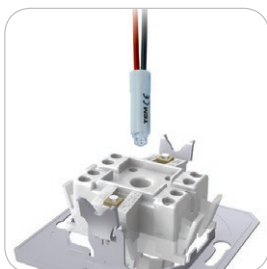

Dobre premyslená konštrukcia vypínača umožňuje jednoduché osvetlenie aj dodatočne.

A well-planned switch construction makes easy illumination possible also subsequently.



Bezskrutkové kontakty umožňujú rýchle a spoľahlivé pripojenie vodičov. Na ten istý kontakt môžete upevniť dva vodiče rozličných priemerov.

Plug-in contacts enable quick and reliable attachment of wires. Two wires of different diameters can be attached to the same contact.

Inštaláčn  krabice s ľahkou inštaláciou vam uľahia pracu. Spravne vzdialenosti su zaruene.

Easy-fitting installation boxes will make your work easier. Proper lengths are guaranteed.



Feeling well in a safe shelter Total confidence in a good construction

SAFE

THRUST

CERTIFIED

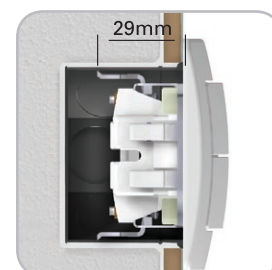

Rozperky umonuuju hľbšie upevnenie (aj cez keramicke obkladacky a pod.)

Fixing claws enable deeper fixing (also through ceramic tiles, etc.)



Všetky spinae majú zreteľnu identifikciu uvedenu na zadnej strane.

All switches have a clear identification in the back.

Spinae boli testovane v sulade s medzinrodnymi normami, ktore zaruuju ich bezpenost a dlhu ivotnosť.

Switches were tested according to international standards which guarantee safety and long life span.



Spofahlivosť prepnutia zabezpeuju kontakty zo striebornej zliatiny (AgNi).

Contacts made of silver alloy (Ag-Ni) guarantee safe switching.

TEM





<i>SPÍNAČE SE</i> <i>SWITCHES SE</i>		188
<i>KRYTY TLAČIDIEL TE</i> <i>BUTTONS TE</i>		192
<i>OSVETLENIE IA</i> <i>ILLUMINATION IA</i>		193
<i>ZÁSUVKY VE</i> <i>SOCKETS VE</i>		196
<i>KOMUNIKÁČNÉ PRVKY KE</i> <i>COMMUNICATIONS KE</i>		199
<i>KRYTY PE</i> <i>COVERS PE</i>		204
<i>ELEKTRONIKA EE</i> <i>ELECTRONICS EE</i>		205
<i>PRÍSLUŠENSTVO AE</i> <i>ACCESSORIES AE</i>		210
<i>RÁMIKY OE</i> <i>SURROUNDS OE</i>		212

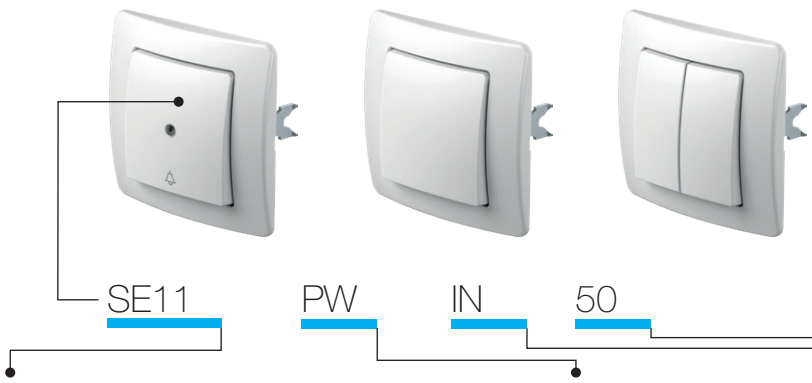

typ type	popis description	technické dáta technical data	farba colour	voliteľné údaje 1 optional data 1	voliteľné údaje 2 optional data 2
SE10	SPÍNAČ JEDNOPÓLOVÝ SWITCH 1WAY	10AX 250V~	<input type="checkbox"/> PW polárna biela polar white	NT neutrálna neutral	50
SE11	TLAČIDLO JEDNOPÓLOVÉ PUSH BUTTON 1WAY	10A 250V~	<input type="checkbox"/> IW slonová kost ivory white	IN indikátor indicator	51
SE22	SPÍNAČ DVOJPÓLOVÝ SWITCH 2POLE	16AX 250V~	<input type="checkbox"/> ES strieborná matná elox silver		03
...	<input type="checkbox"/> CO biely duroplast white thermoset		04
...	<input type="checkbox"/> NB čierna lesklá night black		...

SPÍNAČ JEDNOPÓLOVÝ 16 AX 250 V ~



SE10

- 10 AX 250 V ~, typ SE10
- v súlade s normou EN 60669-1
- bezskrútkové upevnenie vodičov 1,5 – 2,5 mm²



SWITCH 1WAY 10AX 250V~
- 10AX 250V~, type SE10
- in accordance with EN 60669-1
- plug-in contacts 1.5-2.5mm²

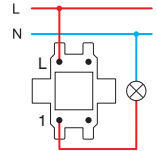

TLAČIDLO JEDNOPÓLOVÉ 10 A 250 V ~



SE11

- 10 A 250 V ~, typ SE11
- v súlade s normou EN 60669-1
- bezskrútkové upevnenie vodičov 1,5 – 2,5 mm²



PUSH BUTTON 1WAY 10A 250V~
- 10A 250V~, type SE11
- in accordance with EN 60669-1
- plug-in contacts 1.5-2.5mm²

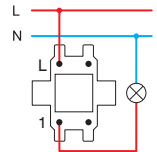

SPÍNAČ DVOJPÓLOVÝ 16AX 250V~



SE22

- 16 AX 250 V ~, typ SE22
- v súlade s normou EN 60669-1
- skrútkové upevnenie vodičov 1,5 – 2,5 mm²
- len v kombinácii s tlačidlom TE10__NT03

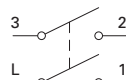

SWITCH 2POLE 16AX 250V~
- 16AX 250V~, type SE22
- in accordance with EN 60669-1
- screw contacts 1.5-2.5mm²
- only in combination with button TE10__NT03

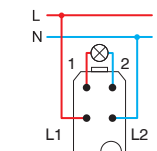

SPÍNAČ SÉRIOVÝ 10 AX 250 V ~



SE50

- 10 AX 250 V ~, typ SE50
- v súlade s normou EN 60669-1
- bezskrútkové upevnenie vodičov 1,5 – 2,5 mm²



SWITCH 2GANG-1WAY 10AX 250V~
- 10AX 250V~, type SE50
- in accordance with EN 60669-1
- plug-in contacts 1.5-2.5mm²

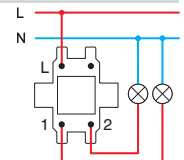

TLAČIDLO SÉRIOVÉ 10 A 250 V ~



SE51

- 10 A 250 V ~, typ SE51
- v súlade s normou EN 60669-1
- bezskrútkové upevnenie vodičov 1,5 – 2,5 mm²

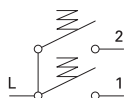

PUSH BUTTON 2GANG-1WAY 10A 250V~

- 10A 250V~, type SE51
- in accordance with EN 60669-1
- plug-in contacts 1.5-2.5mm²

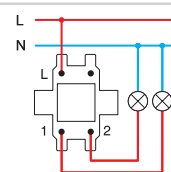

ŽALÚZIOVÝ SPÍNAČ 10AX 250V~



SE52

- 10 AX 250 V ~, typ SE52
- v súlade s normou EN 60669-1
- bezskrútkové upevnenie vodičov 1,5 – 2,5 mm²
- s mechanickou blokadou súčasného zapnutia

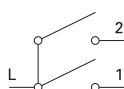

SWITCH SHUTTERS 10AX 250V~

- 10AX 250V~, type SE52
- in accordance with EN 60669-1
- plug-in contacts 1.5-2.5mm²
- with mechanical interblock

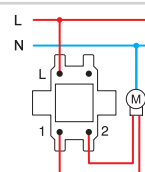

ŽALÚZIOVÉ TLAČIDLO 10 A 250 V ~



SE53

- 10 A 250 V ~, typ SE53
- v súlade s normou EN 60669-1
- bezskrútkové upevnenie vodičov 1,5 – 2,5 mm²
- s mechanickou blokadou súčasného zapnutia

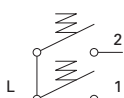

PUSH BUTTON SHUTTERS 10A 250V~

- 10A 250V~, type SE53
- in accordance with EN 60669-1
- plug-in contacts 1.5-2.5mm²
- with mechanical interblock

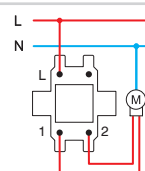

STRIEDAVÝ PREPÍNAČ 10 AX 250 V ~



SE60

- 10 AX 250 V ~, typ SE60
- v súlade s normou EN 60669-1
- bezskrútkové upevnenie vodičov 1,5 – 2,5 mm²

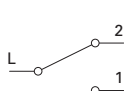

SWITCH 2WAY 10AX 250V~

- 10AX 250V~, type SE60
- in accordance with EN 60669-1
- plug-in contacts 1.5-2.5mm²

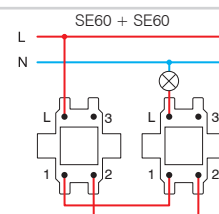

STRIEDAVÝ PREPÍNAČ DVOJITÝ 10 AX 250 V ~



SE63

- 10 AX 250 V ~, typ SE63
- v súlade s normou EN 60669-1
- bezskrútkové upevnenie vodičov 1,5 – 2,5 mm²



SWITCH DOUBLE 2WAY 10AX 250V~

- 10AX 250V~, type SE63
- in accordance with EN 60669-1
- plug-in contacts 1.5-2.5mm²

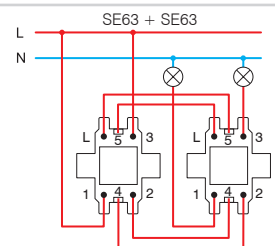

KRÍŽOVÝ PREPÍNAČ 10 AX 250 V ~



SE70

- 10 AX 250 V ~, typ SE70
- v súlade s normou EN 60669-1
- bezskrútkové upevnenie vodičov 1,5 – 2,5 mm²



SWITCH INTERMEDIATE 10AX 250V~

- 10AX 250V~, type SE70
- in accordance with EN 60669-1
- plug-in contacts 1.5-2.5mm²

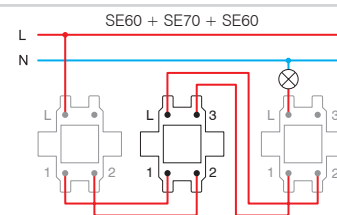

SPÍNAČ JEDNOPÓLOVÝ 10 AX 250 V ~



- SE10PW
- SE10IW
- SE10ES
- SE10CO
- SE10NB

- 10 AX 250 V ~, typ SE10
 - v súlade s normou EN 60669-1
 - bezskrútkové upevnenie vodičov 1,5–2,5 mm²

SWITCH 1WAY 10AX 250V~
 - 10AX 250V~, type SE10
 - in accordance with EN 60669-1
 - plug-in contacts 1.5-2.5mm²



SPÍNAČ JEDNOPÓLOVÝ 10 AX 250 V ~ __ IN



- SE10PWIN
- SE10IWIN
- SE10ESIN
- SE10COIN
- SE10NBIN

- indikátor IN
 - 10 AX 250 V ~, typ SE10
 - v súlade s normou EN 60669-1
 - bezskrútkové upevnenie vodičov 1,5–2,5 mm²

SWITCH 1WAY 10AX 250V~ __ IN
 - IN indicator
 - 10AX 250V~, type SE10
 - in accordance with EN 60669-1
 - plug-in contacts 1.5-2.5mm²



TLAČIDLO JEDNOPÓLOVÉ 10 A 250 V ~



- SE11PW
- SE11IW
- SE11ES
- SE11CO
- SE11NB

- 10 A 250 V ~, typ SE11
 - v súlade s normou EN 60669-1
 - bezskrútkové upevnenie vodičov 1,5–2,5 mm²

PUSH BUTTON 1WAY 10A 250V~
 - 10A 250V~, type SE11
 - in accordance with EN 60669-1
 - plug-in contacts 1.5-2.5mm²



TLAČIDLO JEDNOPÓLOVÉ 10 A 250 V ~ __ TI 50



- SE11PWTI50
- SE11IWTI50
- SE11ESTI50
- SE11COTI50
- SE11NBTI50

- TI 50 indikátor zvonček + tlejvka
 - 10 A 250 V ~, typ SE11
 - v súlade s normou EN 60669-1
 - bezskrútkové upevnenie vodičov 1,5–2,5 mm²

PUSH BUTTON 1WAY 10A 250V~ __ TI 50
 - TI 50 indicator bell+neon lamp
 - 10A 250V~, type SE11
 - in accordance with EN 60669-1
 - plug-in contacts 1.5-2.5mm²



TLAČIDLO JEDNOPÓLOVÉ 10 A 250 V ~ __ TI 51



- SE11PWTI51
- SE11IWTI51
- SE11ESTI51
- SE11COTI51
- SE11NBTI51

- TI 51 indikátor svetlo + tlejvka
 - 10 A 250 V ~, typ SE11
 - v súlade s normou EN 60669-1
 - bezskrútkové upevnenie vodičov 1,5–2,5 mm²

PUSH BUTTON 1WAY 10A 250V~ __ TI 51
 - TI 51 indicator light+neon lamp
 - 10A 250V~, type SE11
 - in accordance with EN 60669-1
 - plug-in contacts 1.5-2.5mm²



TLAČIDLO JEDNOPÓLOVÉ 10 A 250 V ~ __ IL



- SE11PWIL
- SE11IWIL
- SE11ESIL
- SE11COIL
- SE11NBIL

- IL popisný štítok
 - 10 A 250 V ~, typ SE11
 - v súlade s normou EN 60669-1
 - bezskrútkové upevnenie vodičov 1,5–2,5 mm²

PUSH BUTTON 1WAY 10A 250V~ __ IL
 - IL inscription plate
 - 10A 250V~, type SE11
 - in accordance with EN 60669-1
 - plug-in contacts 1.5-2.5mm²



SPÍNAČ DVOJPÓLOVÝ 16 AX 250 V ~ __ IN 03



- SE22PWIN03
- SE22IWIN03
- SE22ESIN03
- SE22NBIN03

- neutrál IN 03 0-1
 - 16 AX 250 V ~, typ SE22
 - v súlade s normou EN 60669-1
 - skrútkové upevnenie vodičov 1,5–2,5 mm²

SWITCH 2POLE 16AX 250V~ __ IN 03
 - IN 03 neutral 0-1
 - 16AX 250V~, type SE22
 - in accordance with EN 60669-1
 - screw contacts 1.5-2.5mm²





- SE50PW
- SE50IW
- SE50ES
- SE50CO
- SE50NB

SPÍNAČ SÉRIOVÝ 10 AX 250 V ~

- 10 AX 250 V ~, typ SE50
- v súlade s normou EN 60669-1
- bezskrútkové upevnenie vodičov 1,5–2,5 mm²

SWITCH 2GANG-1WAY 10AX 250V~

- 10AX 250V~, type SE50
- in accordance with EN 60669-1
- plug-in contacts 1.5-2.5mm²



- SE51PW
- SE51IW
- SE51ES
- SE51CO
- SE51NB

TLAČIDLO SÉRIOVÉ 10 A 250 V ~

- 10 A 250 V ~, typ SE51
- v súlade s normou EN 60669-1
- bezskrútkové upevnenie vodičov 1,5 – 2,5 mm²

PUSH BUTTON 2GANG-1WAY 10A 250V~

- 10A 250V~, type SE51
- in accordance with EN 60669-1
- plug-in contacts 1.5-2.5mm²



- SE52PWNT09
- SE52IWNT09
- SE52ESNT09
- SE52CONT09
- SE52NBNT09

ŽALÚZIOVÝ SPÍNAČ 10 AX 250 V ~ __ NT 09

- NT 09 neutrál hore – dole
- 10 AX 250 V ~, typ SE52
- v súlade s normou EN 60669-1
- bezskrútkové upevnenie vodičov 1,5 – 2,5 mm²
- s mechanickou blokadou súčasného zapnutia

SWITCH SHUTTERS 10AX 250V~ __ NT 09

- NT 09 neutral up-down
- 10AX 250V~, type SE52
- in accordance with EN 60669-1
- plug-in contacts 1.5-2.5mm²
- with mechanical interblock



- SE53PWNT09
- SE53IWNT09
- SE53ESNT09
- SE53CONT09
- SE53NBNT09

ŽALÚZIOVÉ TLAČIDLO 10 A 250 V ~ __ NT 09

- NT 09 neutrál hore – dole
- 10 A 250 V ~, typ SE53
- v súlade s normou EN 60669-1
- bezskrútkové upevnenie vodičov 1,5 – 2,5 mm²
- s mechanickou blokadou súčasného zapnutia

PUSH BUTTON SHUTTERS 10A 250V~ __ NT 09

- NT 09 neutral up-down
- 10A 250V~, type SE53
- in accordance with EN 60669-1
- plug-in contacts 1.5-2.5mm²
- with mechanical interblock



- SE60PW
- SE60IW
- SE60ES
- SE60CO
- SE60NB

STRIEDAVÝ PREPÍNAČ 10 AX 250 V ~

- 10 AX 250 V ~, typ SE60
- v súlade s normou EN 60669-1
- bezskrútkové upevnenie vodičov 1,5 – 2,5 mm²

SWITCH 2WAY 10AX 250V~

- 10AX 250V~, type SE60
- in accordance with EN 60669-1
- plug-in contacts 1.5-2.5mm²



- SE63PW
- SE63IW
- SE63ES
- SE63CO
- SE63NB

STRIEDAVÝ PREPÍNAČ DVOJITÝ 10 AX 250 V ~

- 10 AX 250 V ~, typ SE63
- v súlade s normou EN 60669-1
- bezskrútkové upevnenie vodičov 1,5 – 2,5 mm²

SWITCH DOUBLE 2WAY 10AX 250V~

- 10AX 250V~, type SE63
- in accordance with EN 60669-1
- plug-in contacts 1.5-2.5mm²



- SE70PW
- SE70IW
- SE70ES
- SE70CO
- SE70NB

KRÍŽOVÝ PREPÍNAČ 10 AX 250 V ~

- 10 AX 250 V ~, typ SE70
- v súlade s normou EN 60669-1
- bezskrútkové upevnenie vodičov 1,5 – 2,5 mm²

SWITCH INTERMEDIATE 10AX 250V~

- 10AX 250V~, type SE70
- in accordance with EN 60669-1
- plug-in contacts 1.5-2.5mm²

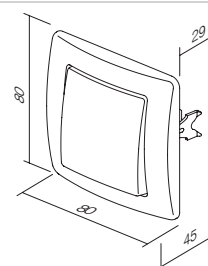
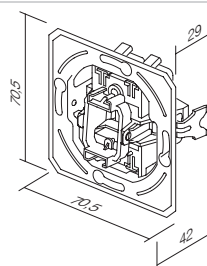

K R Y T Y T L A Č I D I E L T E



TE11

PW

NT

09

typ type	popis description	farba colour	voliteľné údaje 1 optional data 1	voliteľné údaje 2 optional data 2
TE10	KRYT TLAČIDLA BUTTON 1GANG	<input type="checkbox"/> PW polárna biela polar white	NT neutrálna neutral	50
TE11	KRYT TLAČIDLA BUTTON 2GANG	<input type="checkbox"/> IW slonová kosť ivory white	IN indikátor indicator	51
...	...	<input type="checkbox"/> ES strieborná matná elox silver		03
...	...	<input type="checkbox"/> CO biely duroplast white thermoset		04
...	...	<input type="checkbox"/> NB čierna lesklá night black		

KRYT TLAČIDLA



- TE10PW
- TE10IW
- TE10ES
- TE10CO
- TE10NB

- kryt tlačidla s kolískou
BUTTON 1GANG
- button together with carrier



KRYT TLAČIDLA S INDIKÁTOROM

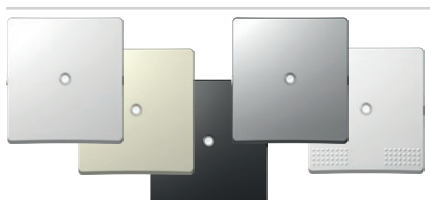

- TE10PWIN
- TE10IWIN
- TE10ESIN
- TE10COIN
- TE10NBIN

- kryt tlačidla s kolískou
BUTTON INDICATOR
- button together with carrier



KRYT TLAČIDLA S POPISNÝM ŠTÍTKOM

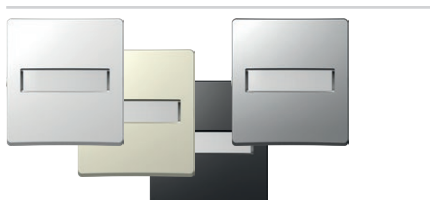

- TE13PWIL
- TE13IWIL
- TE13ESIL
- TE13NBIL

- kryt tlačidla s kolískou a popisným štítkom
BUTTON WITH INSCRIPTION PLATE
- button together with carrier, with inscription plate



KRYT DVOJITÉHO TLAČIDLA



- TE11PW
- TE11IW
- TE11ES
- TE11CO
- TE11NB

- kryt dvojitého tlačidla s kolískou
BUTTON 2GANG
- button 2gang together with carrier

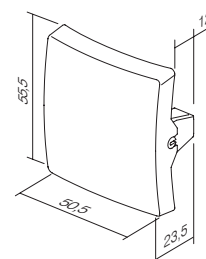
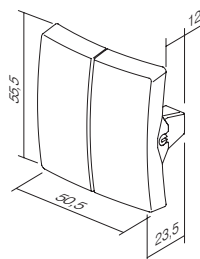

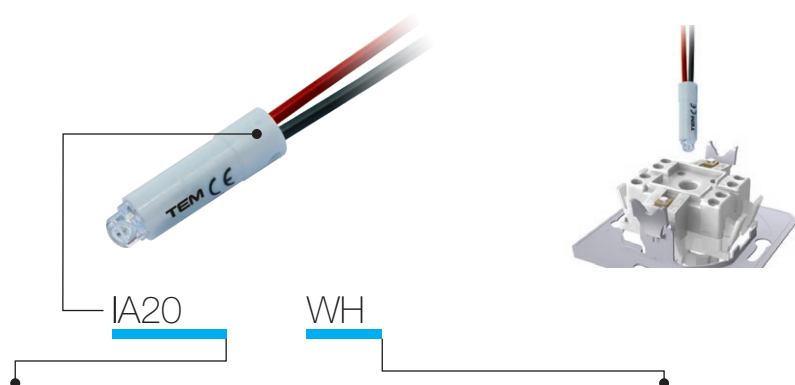

typ type	popis description	technické dáta technical data	farba colour
IA10	TLEJIVKA NEON LAMP	230V~ 0,34W	<input type="checkbox"/> WH biela white
IA20	LED DIÓDA LED LAMP	230V~ 0,40W	<input checked="" type="checkbox"/> BL modrá blue
IA21	LED DIÓDA LED LAMP	24V AC/DC 0,20W	<input checked="" type="checkbox"/> RD červená red
⋮	⋮	⋮	<input checked="" type="checkbox"/> GR zelená green
⋮	⋮	⋮	<input checked="" type="checkbox"/> OR oranžová orange

TLEJIVKA 230 V ~ 0,34 W

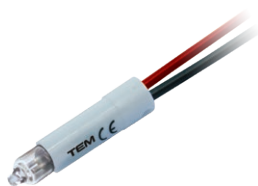

IA10OR

- na indikáciu, osvetlenie alebo stále osvetlenie spínača
- v kombinácii s tlačidlom s indikátorom

NEON LAMP 230V~ 0,34W

- for indication, illumination or constant illumination of switch
- in combination with button with indicator

LED DIÓDA 230 V AC/DC 0,40 W

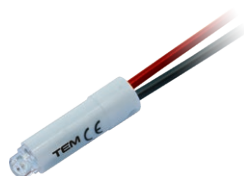

IA20WH
 IA20GR
 IA20RD
 IA20BL

- na indikáciu, osvetlenie alebo stále osvetlenie spínača
- v kombinácii s tlačidlom s indikátorom

LED LAMP 230V AC/DC 0,40W

- for indication, illumination or constant illumination of switch
- in combination with button with indicator

LED DIÓDA 24 V AC/DC 0,20 W

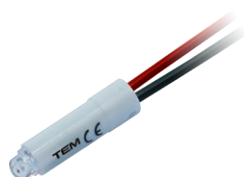

IA21WH
 IA21RD

- na indikáciu, osvetlenie alebo stále osvetlenie spínača
- v kombinácii s tlačidlom s indikátorom

LED LAMP 24V AC/DC 0,20W

- for indication, illumination or constant illumination of switch
- in combination with button with indicator

LED DIÓDA 12 V AC/DC 0,10 W

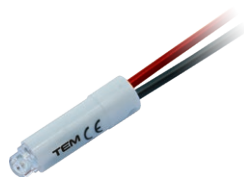

IA22WH
 IA22RD

- na indikáciu, osvetlenie alebo stále osvetlenie spínača
- v kombinácii s tlačidlom s indikátorom

LED LAMP 12V AC/DC 0,10W

- for indication, illumination or constant illumination of switch
- in combination with button with indicator

* Indikácia /
Indication

Osvetlenie /
Illumination

* Stále osvetlenie /
Illumination always on

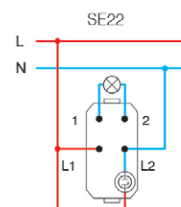
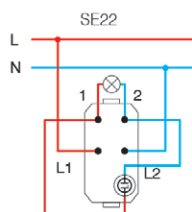
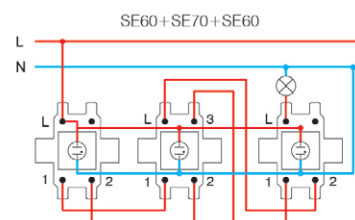
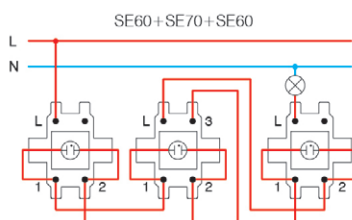
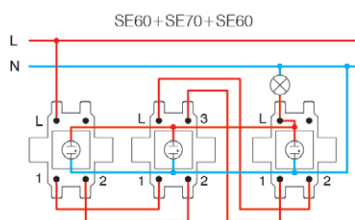
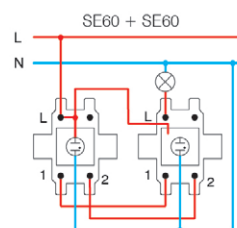
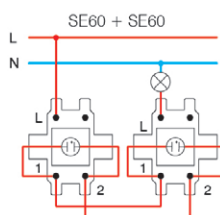
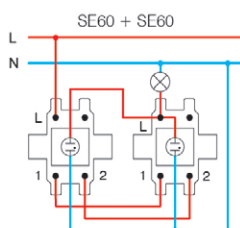
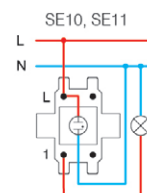
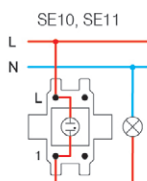
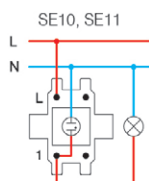

* schéma zapojenia pre úsporné CFL, LED žiarivky
wiring scheme for energy saving lamps (CFL, LED)

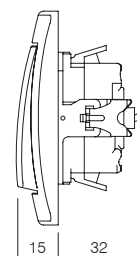

S O C K E T S V E



VE11



PT

XO

KS



typ type	popis description	technické dáta technical data	voliteľné údaje 1 optional data 1	voliteľné údaje 2 optional data 2
VE10	ZÁSUVKA SCHUKO SOCKET SCHUKO	2P+E 16A 250V~	XO bez rámečka without cover plate	KS zabudovaná ochrana pred dotykom s kontaktnými pod napätím shuttered live contacts
VE11	ZÁSUVKA SCHUKO + KRYT SOCKET SCHUKO+COVER	2P+E 16A 250V~		
VE12	ZÁSUVKA SCHUKO SOCKET SCHUKO	2P+E 16A 250V~ BV	KS zabudovaná ochrana pred dotykom s kontaktnými pod napätím shuttered live contacts	
⋮	⋮	⋮		
⋮	⋮	⋮		

farba
colour

<input type="checkbox"/> PW	polárna biela polar white	<input checked="" type="checkbox"/> PT	biela + transparentná white+transparent	<input type="checkbox"/> PP	biela + biela white+white
<input checked="" type="checkbox"/> IW	slonová kosť ivory white	<input checked="" type="checkbox"/> IT	slonová kosť + transparentná ivory+transparent	<input checked="" type="checkbox"/> II	slonová kosť + slonová kosť ivory+ivory
<input type="checkbox"/> ES	strieborná matná elox silver	<input checked="" type="checkbox"/> ST	strieborná matná + transparentná silver+transparent	<input type="checkbox"/> SS	strieborná matná + strieborná matná silver+silver
<input type="checkbox"/> CO	biely duroplast white thermoset	<input checked="" type="checkbox"/> CT	biely duroplast + transparentná white+transparent	<input checked="" type="checkbox"/> BB	čierna matná + čierna matná black+black
<input checked="" type="checkbox"/> NB	čierna matná night black	<input checked="" type="checkbox"/> BT	čierna matná + transparentná black+transparent	<input checked="" type="checkbox"/> RR	červená + červená red+red
<input checked="" type="checkbox"/> RD	červená red	<input checked="" type="checkbox"/> RT	červená + transparentná red+transparent	<input checked="" type="checkbox"/> GG	zelená + zelená green+green
<input checked="" type="checkbox"/> GR	zelená green	<input checked="" type="checkbox"/> GT	zelená + transparentná green+transparent	<input checked="" type="checkbox"/> OO	oranžová + oranžová orange+orange
<input checked="" type="checkbox"/> OR	oranžová orange	<input checked="" type="checkbox"/> OT	oranžová + transparentná orange+transparent		



schuko – vyhovuje EN 60884-1, CEE7 (list III)

Francúzška – vyhovuje NF C 61-314 (list V)

schuko - in accordance with EN 60884-1, CEE7 (standard sheet III)

French - in accordance with NF C 61-314 (standard sheet V)

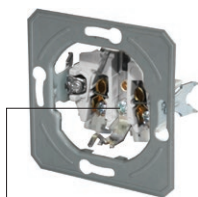
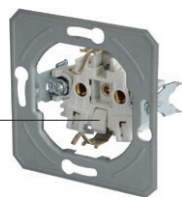
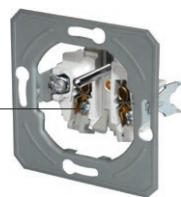
skrutkové upevnenie vodičov
screw contactsBV bezskrutkové upevnenie vodičov
BV plug-in contactsskrutkové upevnenie vodičov
screw contactsBV bezskrutkové upevnenie vodičov
BV plug-in contacts

ZÁSUVKA SCHUKO 2P+E 16 A 250 V ~ __ XO



- VE10PWXO
- VE10IWXO
- VE10ESXO
- VE10COXO
- VE10NBXO
- VE10RDXO
- VE10GRXO
- VE10ORXO

- skrutkové upevnenie vodičov 1,5 – 2,5 mm²
- XO bez rámečka
- 2P+E schuko
- 16A 250 V ~, typ VE10

SOCKET SCHUKO 2P+E 16A 250V~ __ XO

- screw contacts 1.5-2.5mm²
- XO without surround
- 2P+E schuko
- 16A 250V~, type VE10



ZÁSUVKA SCHUKO + KRYT 2P+E 16 A 250 V ~ __ XO



- VE11PTXO
- VE11ITXO
- VE11STXO
- VE11BTXO

- skrutkové upevnenie vodičov 1,5 – 2,5 mm²
- XO bez rámečka
- 2P + E schuko + kryt
- 16A 250 V ~, typ VE11

SOCKET SCHUKO+COVER 2P+E 16A 250V~ __ XO

- screw contacts 1.5-2.5mm²
- XO without surround
- 2P+E schuko+cover
- 16A 250V~, type VE11



ZÁSUVKA SCHUKO 2P+E 16 A 250 V ~ BV __ XO



- VE12PWXO
- VE12IWXO
- VE12ESXO
- VE12COXO
- VE12NBXO
- VE12RDXO
- VE12GRXO
- VE12ORXO

- BV bezskrutkové upevnenie vodičov 1,5 – 2,5 mm²
- XO bez rámečka
- 2P+E schuko
- 16A 250 V ~, typ VE12

SOCKET SCHUKO 2P+E 16A 250V~ BV __ XO

- BV plug-in contacts 1.5-2.5mm²
- XO without surround
- 2P+E schuko
- 16A 250V~, type VE12



ZÁSUVKA SCHUKO + KRYT 2P+E 16 A 250 V ~ BV __ XO

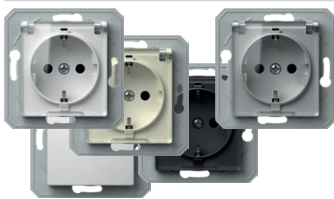

- VE13PTXO
- VE13ITXO
- VE13STXO
- VE13BTXO
- VE13PPXO

- BV bezskrutkové upevnenie vodičov 1,5 – 2,5 mm²
- XO bez rámečka
- 2P + E schuko + kryt
- 16A 250 V ~, typ VE13

SOCKET SCHUKO+COVER 2P+E 16A 250V~ BV __ XO

- BV plug-in contacts 1.5-2.5mm²
- XO without surround
- 2P+E schuko+cover
- 16A 250V~, type VE13



ZÁSUVKA SCHUKO 2P+E 16 A 250 V ~



- VE10PW
- VE10IW
- VE10ES
- VE10CO
- VE10NB

- skrutkové upevnenie vodičov 1,5 – 2,5 mm²
- 2P+E schuko
- 16A 250 V ~, typ VE10

SOCKET SCHUKO 2P+E 16A 250V~

- screw contacts 1.5-2.5mm²
- 2P+E schuko
- 16A 250V~, type VE10



ZÁSUVKA SCHUKO + kryt 2P+E 16 A 250 V ~

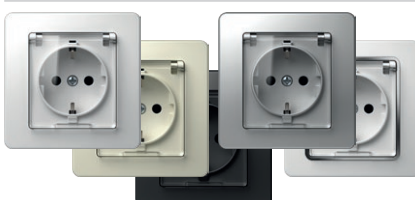

- VE11PT
- VE11IT
- VE11ST
- VE11CT
- VE11BT

- skrutkové upevnenie vodičov 1,5 – 2,5 mm²
- 2P + E schuko + kryt
- 16A 250 V ~, typ VE11

SOCKET SCHUKO+COVER 2P+E 16A 250V~

- screw contacts 1.5-2.5mm²
- 2P+E schuko+cover
- 16A 250V~, type VE11



ZÁSUVKA SCHUKO 2P+E 16A 250V~ BV



- VE12PW
- VE12IW
- VE12ES
- VE12CO
- VE12NB

- BV bezskrutkové upevnenie vodičov 1,5 – 2,5 mm²
- 2P+E schuko
- 16A 250 V ~, typ VE12

SOCKET SCHUKO 2P+E 16A 250V~ BV

- BV plug-in contacts 1.5-2.5mm²
- 2P+E schuko
- 16A 250V~, type VE12



ZÁSUVKA SCHUKO + KRYT 2P+E 16 A 250 V ~ BV



- VE13PT
- VE13IT
- VE13ST
- VE13CT
- VE13BT

- BV bezskrutkové upevnenie vodičov 1,5 – 2,5 mm²
- 2P + E schuko + kryt
- 16A 250 V ~, typ VE13

SOCKET SCHUKO+COVER 2P+E 16A 250V~ BV

- BV plug-in contacts 1.5-2.5mm²
- 2P+E schuko+cover
- 16A 250V~, type VE13



FRANCÚZSKA ZÁSUVKA 2P+E 16 A 250 V ~ __ XO



- VE40PWXO
- VE40IWXO
- VE40ESXO
- VE40COXO
- VE40NBXO
- VE40RDXO
- VE40GRXO
- VE40ORXO

- skrutkové upevnenie vodičov 1,5 – 2,5 mm²
- XO bez rámečka
- 2P+E francúzska
- 16A 250 V ~, typ VE40

SOCKET FRENCH 2P+E 16A 250V~ __ XO

- screw contacts 1.5-2.5mm²
- XO without surround
- 2P+E French
- 16A 250V~, type VE40



FRANCÚZSKA ZÁSUVKA + KRYT 2P+E 16 A 250 V ~ __ XO

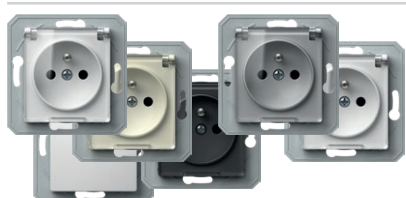

- VE41PTXO
- VE41ITXO
- VE41STXO
- VE41PTXO
- VE41BTXO
- VE41PPXO

- skrutkové upevnenie vodičov 1,5 – 2,5 mm²
- XO bez rámečka
- 2P+E francúzska + kryt
- 16A 250 V ~, typ VE41

SOCKET FRENCH+COVER 2P+E 16A 250V~ __ XO

- screw contacts 1.5-2.5mm²
- XO without surround
- 2P+E French+cover
- 16A 250V~, type VE41



FRANCÚZSKA ZÁSUVKA 2P+E 16 A 250 V ~ BV __ XO



- VE42PWXO
- VE42IWXO
- VE42ESXO
- VE42COXO
- VE42NBXO
- VE42RDXO
- VE42GRXO
- VE42ORXO

- BV bezskrutkové upevnenie vodičov 1,5 – 2,5 mm²
- XO bez rámečka
- 2P+E francúzska
- 16A 250 V ~, typ VE42

SOCKET FRENCH 2P+E 16A 250V~ BV __ XO

- BV plug-in contacts 1.5-2.5mm²
- XO without surround
- 2P+E French
- 16A 250V~, type VE42



FRANCÚZSKA ZÁSUVKA + KRYT 2P+E 16 A 250 V ~ BV __ XO

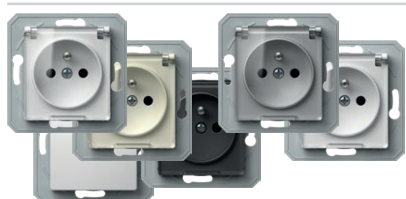

- VE43PTXO
- VE43ITXO
- VE43STXO
- VE43PTXO
- VE43BTXO
- VE43PPXO

- BV bezskrutkové upevnenie vodičov 1,5 – 2,5 mm²
- XO bez rámečka
- 2P+E francúzska + kryt
- 16A 250 V ~, typ VE43

SOCKET FRENCH+COVER 2P+E 16A 250V~ BV __ XO

- BV plug-in contacts 1.5-2.5mm²
- XO without surround
- 2P+E French+cover
- 16A 250V~, type VE43



FRANCÚZSKA ZÁSUVKA 2P+E 16 A 250 V ~



- VE40PW
- VE40IW
- VE40ES
- VE40CO
- VE40NB

- skrutkové upevnenie vodičov 1,5 – 2,5 mm²
- 2P+E francúzska
- 16A 250 V ~, typ VE40

SOCKET FRENCH 2P+E 16A 250V~

- screw contacts 1.5-2.5mm²
- 2P+E French
- 16A 250V~, type VE40



FRANCÚZSKA ZÁSUVKA + KRYT 2P+E 16 A 250 V ~



- VE41PT
- VE41IT
- VE41ST
- VE41CT
- VE41BT

- skrutkové upevnenie vodičov 1,5 – 2,5 mm²
- 2P+E francúzska + kryt
- 16A 250 V ~, typ VE41

SOCKET FRENCH+COVER 2P+E 16A 250V~

- screw contacts 1.5-2.5mm²
- 2P+E French+cover
- 16A 250V~, type VE41



FRANCÚZSKA ZÁSUVKA 2P+E 16 A 250 V ~ BV



- VE42PW
- VE42IW
- VE42ES
- VE42CO
- VE42NB

- BV bezskrutkové upevnenie vodičov 1,5 – 2,5 mm²
- 2P+E francúzska
- 16A 250 V ~, typ VE42

SOCKET FRENCH 2P+E 16A 250V~ BV

- BV plug-in contacts 1.5-2.5mm²
- 2P+E French
- 16A 250V~, type VE42



FRANCÚZSKA ZÁSUVKA + KRYT 2P+E 16 A 250 V ~ BV



- VE43PT
- VE43IT
- VE43ST
- VE43CT
- VE43BT

- BV bezskrutkové upevnenie vodičov 1,5 – 2,5 mm²
- 2P+E francúzska + kryt
- 16A 250 V ~, typ VE43

SOCKET FRENCH+COVER 2P+E 16A 250V~ BV

- BV plug-in contacts 1.5-2.5mm²
- 2P+E French+cover
- 16A 250V~, type VE43





- VE16PWKS
- VE16IWKS
- VE16ESKS
- VE16NBKS

ZÁSUVKA SCHUKO DVOJITÁ 2P+E 16 A 250 V ~

- 2P+E schuko dvojité
- 16A 250 V ~, typ VE16
- v súlade s normou IEC 60884-1, CEE7
- skrutkové upevnenie vodičov 1,5 – 2,5 mm²
- KS ochrana pred dotykom s kontaktní pod napätím

SOCKET SCHUKO DOUBLE 2P+E 16A 250V~

- 2P+E schuko double
- 16A 250V~, type VE16
- in accordance with IEC 60884-1, CEE7
- screw contacts 1.5-2.5 mm²
- KS shuttered live contacts



- VE46PWKS
- VE46IWKS
- VE46ESKS
- VE46NBKS

FRANCÚZSKA ZÁSUVKA DVOJITÁ 2P+E 16 A 250 V ~

- 2P+E francúzska dvojité
- 16A 250 V ~, typ VE46
- v súlade s normami IEC 60884-1, CEE7, NF C 61-314, ČSN 33 2318 a PN-E 93201
- skrutkové upevnenie vodičov 1,5 – 2,5 mm²
- KS ochrana pred dotykom s kontaktní pod napätím

SOCKET FRENCH DOUBLE 2P+E 16A 250V~

- 2P+E French double
- 16A 250V~, type VE46
- in accordance with IEC 60884-1, CEE7; NF C 61-314, ČSN 33 2318; PN-E 93201
- screw contacts 1.5-2.5 mm²
- KS shuttered live contacts



- VE30PW
- VE30IW
- VE30ES
- VE30NB

ZÁSUVKA 2P 16A 250V~

- 2P bez uzemňovacieho kontaktu
- 16A 250V ~
- v súlade s normou EN 60884-1, CEE7 (list I)
- skrutkové upevnenie vodičov 1,5 – 2,5 mm²

SOCKET 2P 16A 250V~

- 2P without earthing contact
- 16A 250V~
- in accordance with EN 60884-1, CEE7 (standard sheet I)
- screw contacts 1.5-2.5mm²

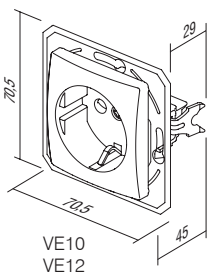

VE10
VE12

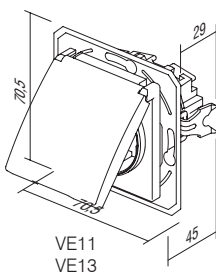

VE11
VE13
VE41
VE43

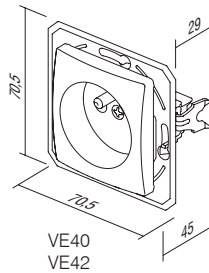

VE40
VE42

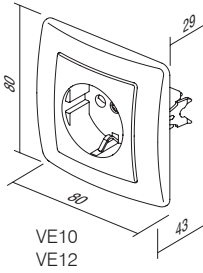

VE10
VE12

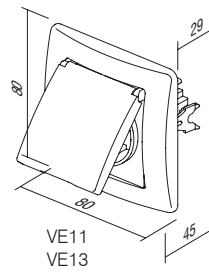

VE11
VE13
VE41
VE43

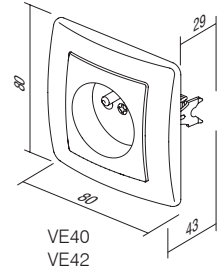

VE40
VE42

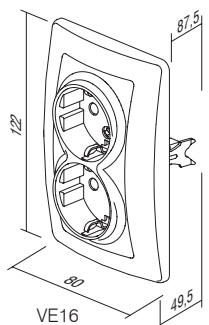

VE16

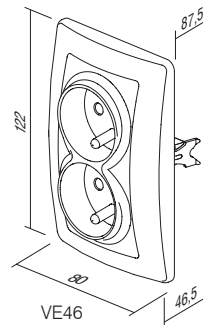

VE46

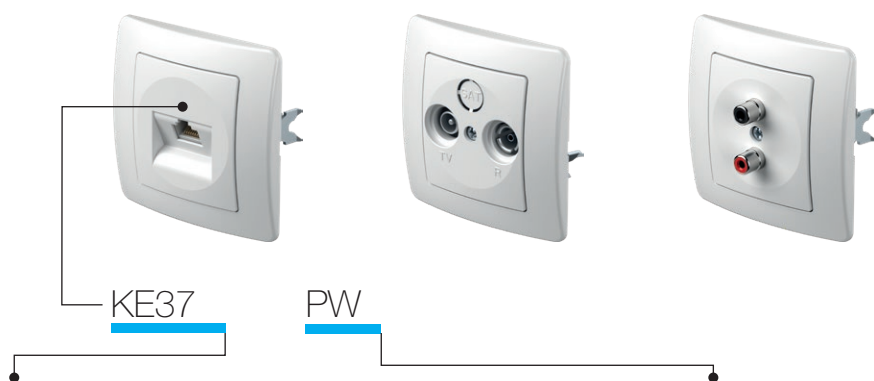

typ type	popis description	technické dáta technical data	farba colour
KE11	ZÁSUVKA TV-R KONCOVÁ SOCKET TV-R END-LINE	1dB	<input type="checkbox"/> PW polárna biela polar white
KE12	ZÁSUVKA TV-R PRIEBEŽNÁ SOCKET TV-R THROUGHPASS	10dB	<input type="checkbox"/> IW slonová košť ivory white
KE16	ZÁSUVKA SAT-TV-R KONCOVÁ SOCKET SAT-TV-R END-LINE	3dB	<input type="checkbox"/> ES strieborná matná elox silver
⋮	⋮	⋮	<input type="checkbox"/> CO biely duroplast white thermoset
⋮	⋮	⋮	<input type="checkbox"/> NB čierna lesklá night black

ZÁSUVKA TV-R KONCOVÁ 1 dB



KE11

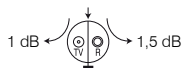

- TV-R koncová
- frekvenčné pásmo 5 ÷ 862MHz
- útlm: R – 1,5 dB, TV – 1 dB
- v súlade s normou EN 50083-1
- skrutkové upevnenie vodičov

SOCKET TV-R END-LINE 1dB

- TV-R end-line
- frequency range 5÷862MHz
- reduction: R-1.5dB, TV-1dB
- in accordance with EN 50083-1
- screw contacts

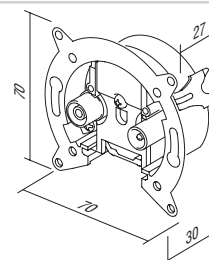

ZÁSUVKA TV-R PRIEBEŽNÁ 10 dB



KE12

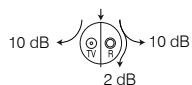

- TV-R priebežná zásuvka
- frekvenčné pásmo 5 ÷ 862MHz
- útlm: R – 10dB, TV – 10dB, prechod – 2 dB
- v súlade s normou EN 50083-1
- skrutkové upevnenie vodičov

SOCKET TV-R TROUGHPASS 10dB

- TV-R troughpass
- frequency range 5÷862MHz
- reduction: R-10dB, TV-10dB, trough-2dB
- in accordance with EN 50083-1
- screw contacts

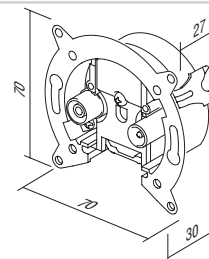

ZÁSUVKA SAT-TV-R KONCOVÁ 3 dB



KE16

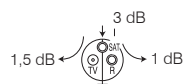

- SAT-TV-R koncová
- frekvenčné pásmo 5 ÷ 2400MHz
- útlm: R – 1 dB, TV – 1,5 dB, SAT – 3 dB
- montáž do krabice Ø 60 svorkami alebo skrutkami
- v súlade s normou EN 50083-1
- skrutkové upevnenie vodičov

SOCKET SAT-TV-R END-LINE 3dB

- SAT-TV-R end-line
- frequency range 5÷2400MHz
- reduction: R-1dB, TV-1.5dB, SAT-3dB
- for mounting in round box Ø60 with claws or screws
- in accordance with EN 50083-1
- screw contacts

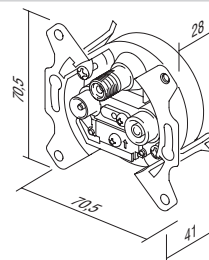

ZÁSUVKA TEL KS RJ11 6/4



KE36

- KS keystone štandard upevnenia
- RJ11 6/4
- v súlade s normou IEC 60603-7

SOCKET TEL KS RJ11 6/4

- KS keystone fixing standard
- RJ11 6/4
- in accordance with IEC 60603-7

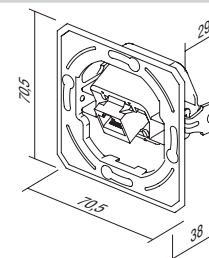



KE37

ZÁSUVKA KAT. 5e KS RJ45 8/8

- KS keystone štandard upevnenia
- KAT. 5e, RJ45 8/8
- v súlade s normou IEC 60603-7

SOCKET CAT5e KS RJ45 8/8

- KS keystone fixing standard
- CAT5e, RJ45 8/8
- in accordance with IEC 60603-7

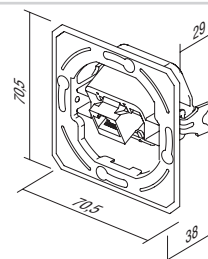

KE40

ZÁSUVKA KAT. 6s KS RJ45 8/8 SLIM

- KS keystone štandard upevnenia
- KAT. 6s, RJ45 8/8
- v súlade s normou IEC 60603-7

SOCKET CAT6s KS RJ45 8/8 SLIM

- KS keystone fixing standard
- CAT6s, RJ45 8/8
- in accordance with IEC 60603-7

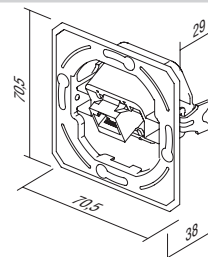

KE38

ZÁSUVKA TEL KS DVOJITÁ 2 x RJ11 6/4

- KS keystone štandard upevnenia
- 2 x RJ11 6/4
- v súlade s normou IEC 60603-7

SOCKET TEL KS DOUBLE 2x RJ11 6/4

- KS keystone fixing standard
- 2x RJ11 6/4
- in accordance with IEC 60603-7

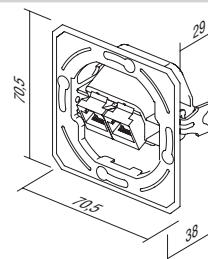

KE39

ZÁSUVKA KAT. 5e KS DVOJITÁ 2 x RJ45 8/8

- KS keystone štandard upevnenia
- 2 x KAT. 5e, RJ45 8/8
- v súlade s normou IEC 60603-7

SOCKET CAT5e KS DOUBLE 2x RJ45 8/8

- KS keystone fixing standard
- 2x CAT5e, RJ45 8/8
- in accordance with IEC 60603-7

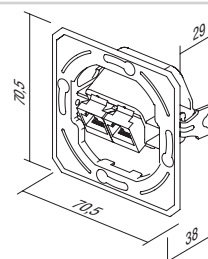

KE41

ZÁSUVKA KAT. 6s KS DVOJITÁ 2 x RJ45 8/8 SLIM

- KS keystone štandard upevnenia
- 2 x KAT. 6s, RJ45 8/8
- v súlade s normou IEC 60603-7

SOCKET CAT6s KS DOUBLE 2x RJ45 8/8 SLIM

- KS keystone fixing standard
- 2x CAT6s, RJ45 8/8
- in accordance with IEC 60603-7

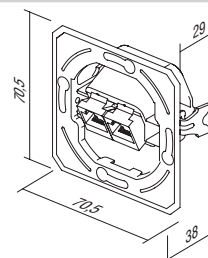

KE45

ADAPTÉR KS SAMOSTATNÝ

- keystone KS štandard pripojenia – samostatný
- AMP, Avaya, Brandrex, FMT, Mfico, Tyco, ...
- komunikačný modul nie je súčasťou dodávky

ADAPTER KS SINGLE

- KS keystone fixing standard - single
- AMP, Avaya, Brandrex, FMT, Mfico, Tyco, ...
- communication module not included

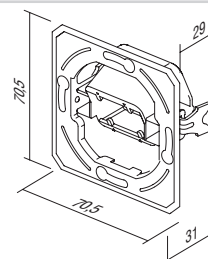



KE46

ADAPTÉR KS DVOJITÝ

- keystone KS štandard pripojenia – dvojitý
- AMP, Tyco, ...
- komunikačný modul nie je súčasťou dodávky

ADAPTER KS DOUBLE

- KS keystone fixing standard - double
- AMP, Tyco, ...
- communication module not included

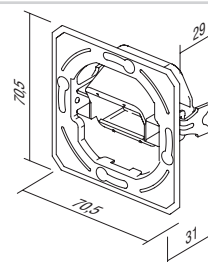

KE47

ADAPTÉR PD DVOJITÝ

- štandard upevnenia PD Panduit Mini-COM – dvojitý
- komunikačný modul nie je súčasťou dodávky

ADAPTER PD DOUBLE

- PD Panduit Mini-COM fixing standard - double
- communication module not included

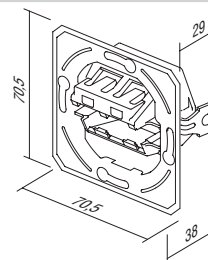

ZÁSUVKA TV ZÁKLADNÁ 0dB



- KE10PW
- KE10IW
- KE10ES
- KE10CO
- KE10NB

- TV základná
- útlm 0 dB
- zadný konektor – F štandard

SOCKET TV BASIC 0dB

- TV basic
- reduction 0dB
- back connector – F standard



ZÁSUVKA TV-R KONCOVÁ 1 dB



- KE11PW
- KE11IW
- KE11ES
- KE11CO
- KE11NB

- TV-R koncová
- frekvenčné pásmo 5 ÷ 862MHz
- útlm: R – 1,5 dB, TV – 1 dB
- v súlade s normou EN 50083-1
- skrutkové upevnenie vodičov

SOCKET TV-R END-LINE 1dB

- TV-R end-line
- frequency range 5÷862 MHz
- reduction: R-1.5dB, TV-1dB
- in accordance with EN 50083-1
- screw contact



ZÁSUVKA TV-R PRIEBEŽNÁ 10 dB



- KE12PW
- KE12IW
- KE12ES
- KE12CO
- KE12NB

- TV-R priebežná zásuvka
- frekvenčné pásmo 5 ÷ 862MHz
- útlm: R – 10dB, TV – 10dB, prechod – 2 dB
- v súlade s normou EN 50083-1
- skrutkové upevnenie vodičov

SOCKET TV-R TROUGH-PASS 10dB

- TV-R troughpass
- frequency range 5÷862 MHz
- reduction: R-10dB, TV-10dB, trough-2dB
- in accordance with EN 50083-1
- screw contacts



ZÁSUVKA SAT-TV-R KONCOVÁ 3 dB



- KE16PW
- KE16IW
- KE16ES
- KE16CO
- KE16NB

- SAT-TV-R koncová
- frekvenčné pásmo 5 ÷ 2 400 MHz
- útlm: R – 1 dB, TV – 1,5 dB, SAT – 3 dB
- v súlade s normou EN 50083-1
- skrutkové upevnenie vodičov

SOCKET SAT-TV-R END-LINE 3dB

- SAT-TV-R end-line
- frequency range 5÷2400 MHz
- reduction: R-1dB, TV-1.5dB, SAT-3dB
- in accordance with EN 50083-1
- screw contacts



AUDIO ZÁSUVKA 2xRCA



- KE22PW
- KE22IW
- KE22ES
- KE22CO
- KE22NB

- audio 2 x RCA
- upevnenie vodičov spájkovaním

SOCKET AUDIO 2xRCA

- audio 2xRCA
- soldering connection of cable



ZÁSUVKA AUDIO REPRODUKTOROVÁ



- KE23PW
- KE23IW
- KE23ES
- KE23CO
- KE23NB

- audio 2 x Ø 4 mm
- na pripojenie reproduktorového vodiča, banánovej zástrčky Ø 4 mm alebo vidlicovej káblovej pätky
- upevnenie vodičov vzadu spájkovaním

SOCKET AUDIO LOUDSPEAKERS

- audio 2x Ø4mm
- to accommodate speaker wire, banana plug Ø4mm or spades
- soldering connection of cable at the back side



ZÁSUVKA TEL KS RJ11 6/4

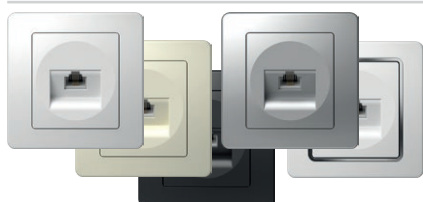

- KE36PW
- KE36IW
- KE36ES
- KE36CO
- KE36NB

- KS keystone štandard upevnenia
- RJ11 6/4
- v súlade s normou IEC 60603-7

SOCKET TEL KS RJ11 6/4

- KS keystone fixing standard
- RJ11 6/4
- in accordance with IEC 60603-7





- KE37PW
- KE37IW
- KE37ES
- KE37CO
- KE37NB

ZÁSUVKA KAT. 5e KS RJ45 8/8

- KS keystone štandard upevnenia
- KAT. 5e, RJ45 8/8
- v súlade s normou IEC 60603-7

SOCKET CAT5e KS RJ45 8/8

- KS keystone fixing standard
- CAT5e, RJ45 8/8
- in accordance with IEC 60603-7



- KE40PW
- KE40IW
- KE40ES
- KE40CO
- KE40NB

ZÁSUVKA KAT. 6s KS RJ45 8/8 SLIM

- KS keystone štandard upevnenia
- KAT. 6s, RJ45 8/8
- v súlade s normou IEC 60603-7

SOCKET CAT6s KS RJ45 8/8 SLIM

- KS keystone fixing standard
- CAT6s, RJ45 8/8
- in accordance with IEC 60603-7

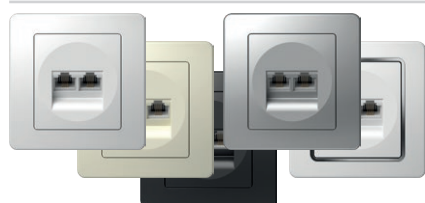

- KE38PW
- KE38IW
- KE38ES
- KE38CO
- KE38NB

ZÁSUVKA TEL KS DVOJITÁ 2 x RJ11 6/4

- KS keystone štandard upevnenia
- 2x RJ11, 6/4
- v súlade s normou IEC 60603-7

SOCKET TEL KS DOUBLE 2x RJ11 6/4

- KS keystone fixing standard
- 2x RJ11, 6/4
- in accordance with IEC 60603-7



- KE39PW
- KE39IW
- KE39ES
- KE39CO
- KE39NB

ZÁSUVKA KAT. 5e KS DVOJITÁ 2 x RJ45 8/8

- KS keystone štandard upevnenia
- 2 x KAT. 5e, RJ45 8/8
- v súlade s normou IEC 60603-7

SOCKET CAT5e KS DOUBLE 2x RJ45 8/8

- KS keystone fixing standard
- 2x CAT5e, RJ45 8/8
- in accordance with IEC 60603-7



- KE41PW
- KE41IW
- KE41ES
- KE41CO
- KE41NB

ZÁSUVKA KAT. 6s KS DVOJITÁ 2 x RJ45 8/8 SLIM

- KS keystone štandard upevnenia
- 2 x KAT. 6s, RJ45 8/8
- v súlade s normou IEC 60603-7

SOCKET CAT6s KS DOUBLE 2x RJ45 8/8 SLIM

- KS keystone fixing standard
- 2x CAT6s, RJ45 8/8
- in accordance with IEC 60603-7

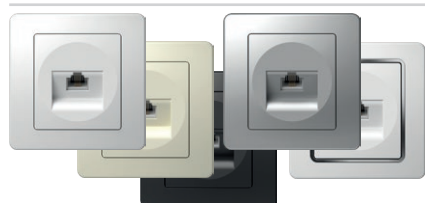

- KE35PW
- KE35IW
- KE35ES
- KE35CO
- KE35NB

ZÁSUVKA TEL LT RJ11 6/4

- skrutka TEL LT
- skrutkové upevnenie vodičov
- RJ11 6/4
- v súlade s normou IEC 60603-7

SOCKET TEL LT RJ11 6/4

- TEL LT screw
- screw contacts
- RJ11 6/4
- in accordance with IEC 60603-7

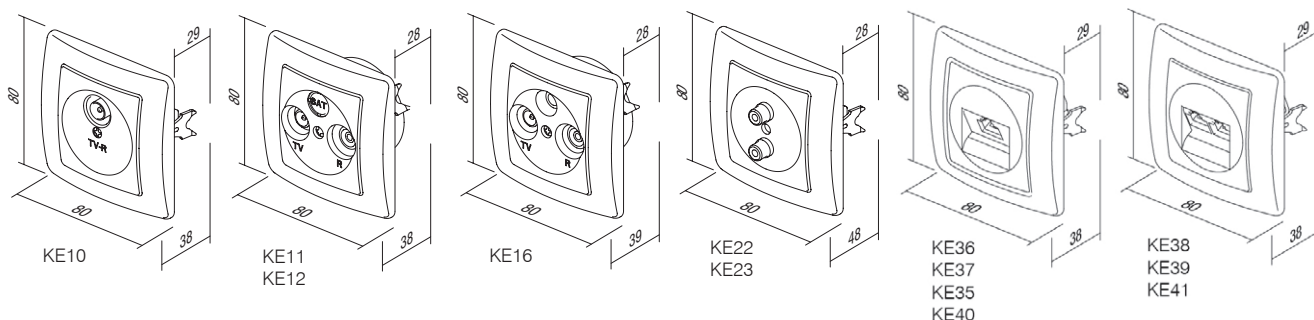

K R Y T Y P R E K O M U N I K Á Č N É P R V K Y K E

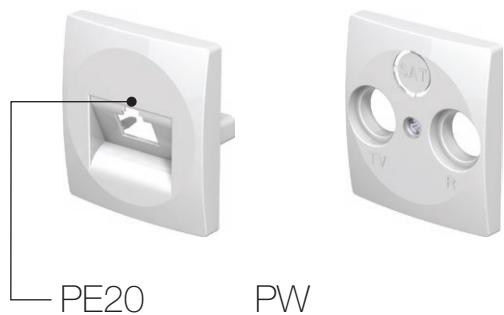

typ type	popis description	technické dáta technical data	farba colour
PE10	KRYT TV-R COVER TV-R	2P/3P	<input type="checkbox"/> PW polárna biela polar white
PE20	KRYT KS SAMOSTATNÝ COVER KS SINGLE		<input type="checkbox"/> IW slonová kosť ivory white
PE21	KRYT KS DVOJITÝ COVER KS DOUBLE		<input type="checkbox"/> ES strieborná matná elox silver
⋮	⋮	⋮	<input type="checkbox"/> CO biely duroplast white thermoset
			<input type="checkbox"/> NB čierna lesklá night black

KRYT TV-R 2P/3P

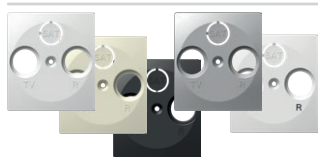

- PE10PW
- PE10IW
- PE10ES
- PE10CO
- PE10NB

- TV-R kryt, 2P alebo 3P so skrutkou
COVER TV-R 2P/3P
- TV-R cover, 2P or 3P with screw



KRYT KS SAMOSTATNÝ



- PE20PW
- PE20IW
- PE20ES
- PE20CO
- PE20NB

- KS kryt samostatný
COVER KS SINGLE
- KS cover single



KRYT KS DVOJITÝ

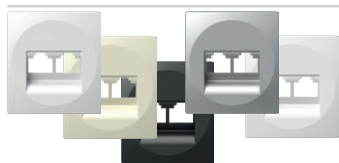

- PE21PW
- PE21IW
- PE21ES
- PE21NB

- KS kryt dvojitý
COVER KS DOUBLE
- KS cover double



KRYT TAE/TDO



- PE30PW
- PE30IW
- PE30ES
- PE30NB

- TAE alebo TDO kryt so skrutkou
COVER TAE/TDO
- TAE or TDO cover with screw



KRYT IR SPÍNAČ



- PE32PW
- PE32IW
- PE32ES
- PE32NB

- kryt IR spínač
COVER IR SWITCH
- cover IR switch

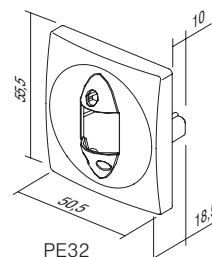
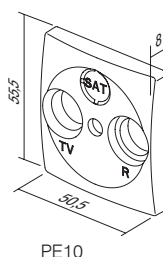
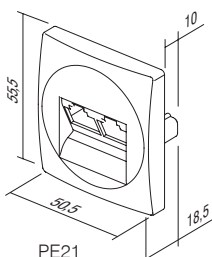
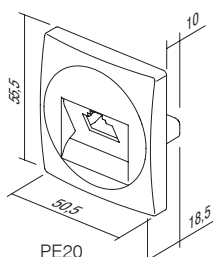
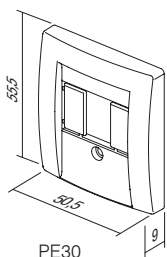

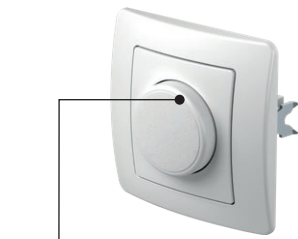

EE15

PW

typ type	popis description	technické dáta technical data	farba colour
EE15	STMIEVAČ ROTAČNÝ STRIEDAVÝ DIMMER ROTATIVE 2WAY	RL 400W	<input type="checkbox"/> PW polárna biela polar white
EE16	STMIEVAČ ROTAČNÝ STRIEDAVÝ DIMMER ROTATIVE 2WAY	RLC 400W	<input type="checkbox"/> IW slonová kosť ivory white
EE19	STMIEVAČ ROTAČNÝ STRIEDAVÝ DIMMER ROTATIVE 2WAY	LED 100W	<input type="checkbox"/> ES strieborná matná elox silver
⋮	⋮	⋮	<input type="checkbox"/> CO biely duroplast white thermoset
⋮	⋮	⋮	<input type="checkbox"/> NB čierna lesklá night black

STMIEVAČ ROTAČNÝ STRIEDAVÝ RL 400 W



EE15

- ovládanie rotácie so striedavým prepínačom
- zaťaženie RL, 40 W – 400 W
- kombinácia so striedavým prepínačom je možná
- kombinácia s viacerými stmievačmi nie je povolená
- v súlade s normami EN 60669-1 a STN EN 60669-2-1
- bezskrútkové upevnenie vodičov 1,5 mm²
- napájanie 230 V ~ 50 Hz
- vnútorný priemer tlačidla Ø 6 mm
- obsahuje náhradnú poistku

DIMMER ROTATIVE 2WAY RL 400W

- rotation control with 2-way switch
- load RL, 40W - 400W
- 2-way switch combination is possible
- more dimmers combination is not allowed
- in accordance with EN 60669-1 and EN 60669-2-1
- plug-in contacts 1.5mm²
- supply 230V ~ 50Hz
- button inner diameter Ø6mm
- replaceable fuse included

STMIEVAČ ROTAČNÝ STRIEDAVÝ RLC 400 W



EE16

- ovládanie rotácie so striedavým prepínačom
- zaťaženie RLC, 20 W – 400 W
- kombinácia so striedavým prepínačom
- kombinácia s viacerými stmievačmi nie je povolená
- v súlade s normami EN 60669-1 a STN EN 60669-2-1
- bezskrútkové upevnenie vodičov 1,5 mm²
- vnútorný priemer tlačidla Ø 6 mm
- napájanie 230 V ~ 50 Hz
- elektronický istič

DIMMER ROTATIVE 2WAY RLC 400W

- rotation control with 2-way switch
- load RLC, 20W - 400W
- 2-way switch combination is possible
- more dimmers combination is not allowed
- in accordance with EN 60669-1 and EN 60669-2-1
- plug-in contacts 1.5mm²
- supply 230V ~ 50Hz
- button inner diameter Ø6mm
- electronic fuse



EE19

STMIEVAČ ROTAČNÝ STRIEDAVÝ LED 100 W

- ovládanie rotáciou so striedavým prepínačom
- zaťaženie: LED, 0 – 100 W (max. 10 LED žiaroviek)
GLS, 10 – 250 W
- kombinácia so striedavým prepínačom je možná
- kombinácia s viacerými stmievačmi nie je povolená
- v súlade s normami EN 60669-1 a STN EN 60669-2-1
- bezskrútkové upevnenie vodičov 1,5 mm²
- napájanie 230 V ~ 50 Hz
- obsahuje náhradnú poistku
- vnútorný priemer tlačidla Ø 6 mm

DIMMER ROTATIVE 2WAY LED 100W

- rotation control with 2-way switch
- load: LED, 0-100W (max. 10 LEDs)
GLS, 10-250W
- 2-way switch combination is possible
- more dimmers combination is not allowed
- in accordance with EN 60669-1 and EN 60669-2-1
- plug-in contacts 1.5mm²
- supply 230V~ 50Hz
- replaceable fuse included
- button inner diameter Ø6mm

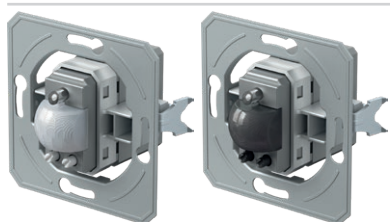

- EE32A1
- EE32A2

IR SPÍNAČ 5 A 250 V ~

- infračervený spínač
- napájacie napätie: 230 V ~ ±10 % 50 Hz
- relé: - 5 A/250 V ~ výstup s obmedzeným prúdom
s vysokým odporom prepínania v nule
- stupeň krytia: IP40
- prierez vodiča na kontaktnej svorke: 0,75 – 2,5 mm²
- uhol detekcie: až 110° pri 20 °C
- detekčná oblasť: pribl. 8 m pri 20 °C
- nastavitelnosť trvania: od pribl. 5 s až 12 min.
- nastavitelnosť jasů: od pribl. 5 do 200 lx
- prevádzková teplota: od 0 °C do +40 °C
- nie je vhodný pre montáž do krábíc s hĺbkou 45 mm
- len pre použitie v interiéri

IR SWITCH 5A 230V~

- IR infrared switch
- supply voltage: 230V~ ±10 % 50Hz
- relay: 5A / 250V~ output for limited current with
high resistance for zero crossing
- protection rating: IP40
- cross-section of wires at the contact
terminal: 0.75 - 2.5 mm²
- detection angle: up to 110° at 20°C
- detection area: approx. 8 m at 20°C
- adjustability of duration: from approx. 5 s to 12 min
- adjustability of brightness: from approx. 5 to 200 LUX
- operating temperature: from 0°C to +40°C
- not suitable for installation in 45 mm deep boxes
- only for indoor usage



- EE15PW
- EE15IW
- EE15ES
- EE15CO
- EE15NB

STMIEVAČ ROTAČNÝ STRIEDAVÝ RL 400 W

- ovládanie rotáciou so striedavým prepínačom
- zaťaženie RL, 40 W – 400 W
- kombinácia so striedavým prepínačom je možná
- kombinácia s viacerými stmievačmi nie je povolená
- v súlade s normami EN 60669-1 a STN EN 60669-2-1
- bezskrútkové upevnenie vodičov 1,5 mm²
- napájanie 230 V ~ 50 Hz
- obsahuje náhradnú poistku

DIMMER ROTATIVE 2WAY RL 400W

- rotation control with 2-way switch
- load RL, 40W - 400W
- 2-way switch combination is possible
- more dimmers combination is not allowed
- in accordance with EN 60669-1 and EN 60669-2-1
- plug-in contacts 1.5mm²
- supply 230V~ 50Hz
- replaceable fuse included



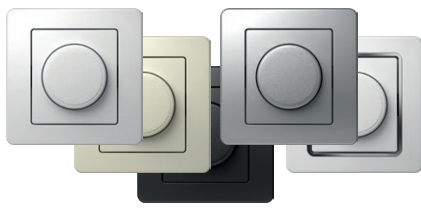

- EE16PW
- EE16IW
- EE16ES
- EE16CO
- EE16NB

STMIEVAČ ROTAČNÝ STRIEDAVÝ RLC 400 W

- ovládanie rotácie so striedavým prepínačom
- zaťaženie RLC, 20 W – 400 W
- kombinácia so striedavým prepínačom je možná
- kombinácia s viacerými stmievačmi nie je povolená
- v súlade s normami EN 60669-1 a STN EN 60669-2-1
- bezskrútkové upevnenie vodičov 1,5 mm²
- napájanie 230 V ~ 50 Hz
- obsahuje náhradnú poistku



DIMMER ROTATIVE 2WAY RLC 400W

- rotation control with 2-way switch
- load RLC, 20W - 400W
- 2-way switch combination is possible
- more dimmers combination is not allowed
- in accordance with EN 60669-1 and EN 60669-2-1
- plug-in contacts 1.5mm²
- supply 230V~ 50Hz
- electronic fuse

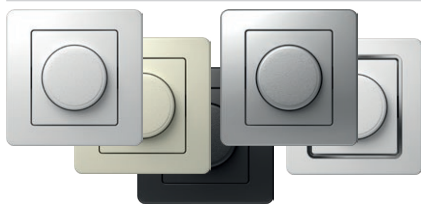

- EE19PW
- EE19IW
- EE19ES
- EE19CO
- EE19NB

STMIEVAČ ROTAČNÝ STRIEDAVÝ LED 100 W

- ovládanie rotáciou so striedavým prepínačom
- zaťaženie: LED, 0 – 100 W (max. 10 LED žiaroviek)
GLS, 10 – 250 W
- kombinácia so striedavým prepínačom je možná
- kombinácia s viacerými stmievačmi nie je povolená
- v súlade s normami EN 60669-1 a STN EN 60669-2-1
- bezskrútkové upevnenie vodičov 1,5 mm²
- napájanie 230 V ~ 50 Hz
- obsahuje náhradnú poistku



DIMMER ROTATIVE 2WAY LED 100W

- rotation control with 2-way switch
- load: LED, 0-100W (max. 10 LEDs)
GLS, 10-250W
- 2-way switch combination is possible
- more dimmers combination is not allowed
- in accordance with EN 60669-1 and EN 60669-2-1
- plug-in contacts 1.5mm²
- supply 230V~ 50Hz
- replaceable fuse included



- EE32PW
- EE32IW
- EE32ES
- EE32CO
- EE32NB

IR SPÍNAČ 5 A 250 V ~

- infračervený spínač
- napájacie napätie: 230 V ~ ±10 % 50 Hz
- relé: 5 A / 250 V ~ výstup s obmedzeným prúdom s vysokým odporom prespinanie v nule
- stupeň krytia: IP40
- prierez vodiča na kontaktnej svorke: 0,75 – 2,5 mm²
- uhol detekcie: až 110° pri 20 °C
- detekčná oblasť: pribl. 8 m pri 20 °C
- nastavitelnosť trvania: od pribl. 5 s až 12 min.
- nastavitelnosť jasů: od pribl. 5 do 200 lx
- prevádzková teplota: od 0 °C do +40 °C
- nie je vhodný pre montáž do krábíc s hĺbkou 45 mm
- len pre použitie v interiéri



IR SWITCH 5A 230V~

- IR infrared switch
- supply voltage: 230V~ ±10 % 50Hz
- relay: 5A / 250V~ output for limited current with high resistance for zero crossing
- protection rating: IP40
- cross-section of wires at the contact terminal: 0.75 - 2.5 mm²
- detection angle: up to 110° at 20°C
- detection area: approx. 8 m at 20°C
- adjustability of duration: from approx. 5 s to 12 min
- adjustability of brightness: from approx. 5 to 200 LUX
- operating temperature: from 0°C to +40°C
- not suitable for installation in 45 mm deep boxes
- only for indoor usage

EE15, EE16, EE19

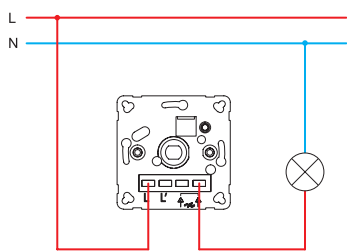

EE15, EE16, EE19

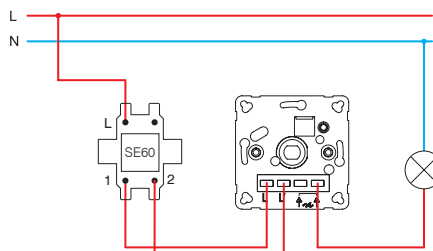

EE15, EE16, EE19

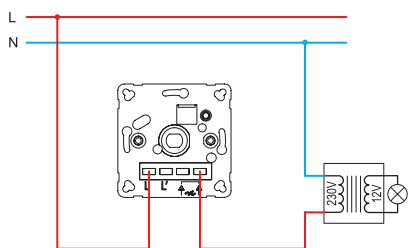

EE15, EE16, EE19

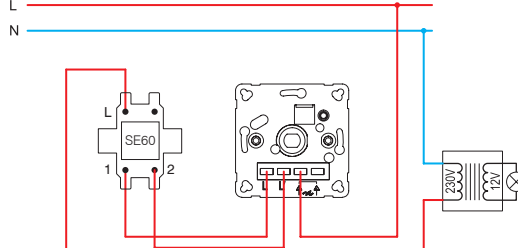

EE16, EE19

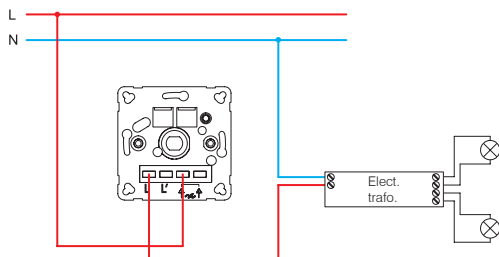

EE16, EE19

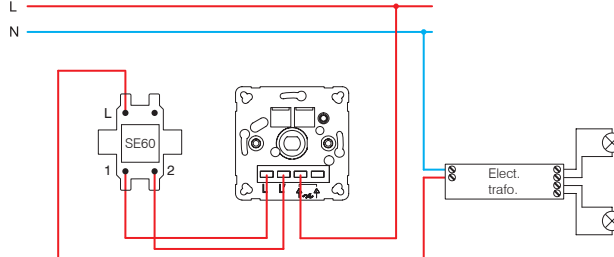

EE15 (40÷400W)

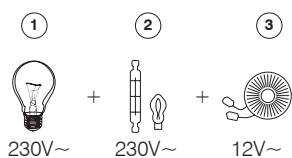

EE16 (20÷400W)

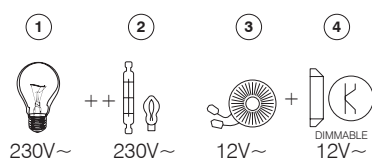

EE19 (GLS 10÷250W ; LED 0÷100W)

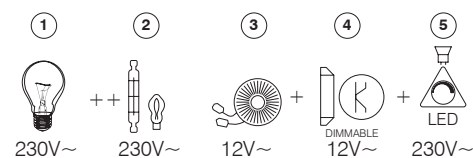

- 1 – žiarovka / incandescent lamp
- 2 – halogénová žiarovka / halogen lamp

- 3 – klasický transformátor / classical transformer
- 4 – stmievateľný elektronický transformátor / dimmable electronic transformer
- 5 – stmievateľná LED žiarovka / dimmable LED lamp

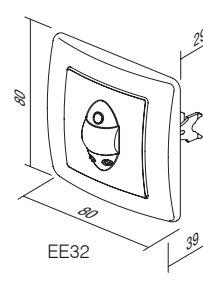
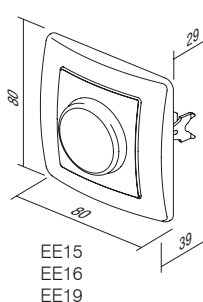
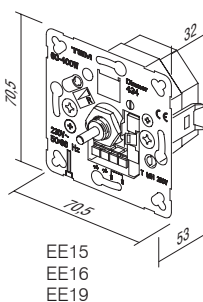

K R Y T Y P E

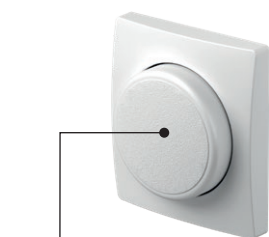

PE41

PW

typ type	popis description	farba colour
PE41	KRYT NA STMIEVAČ COVER DIMMER	<input type="checkbox"/> PW polárna biela <i>polar white</i> <input type="checkbox"/> IW slonová kosť <i>ivory white</i> <input type="checkbox"/> ES strieborná matná <i>elox silver</i> <input type="checkbox"/> CO biely duroplast <i>white thermoset</i> <input type="checkbox"/> NB čierna lesklá <i>night black</i>



- PE41PW
- PE41IW
- PE41ES
- PE41CO
- PE41NB

KRYT NA STMIEVAČ Ø 6

- kryt na stmievač Ø 6 mm
- pre EE15, EE16, EE19

COVER DIMMER Ø6
- cover dimmer Ø6mm
- for EE15, EE16, EE19

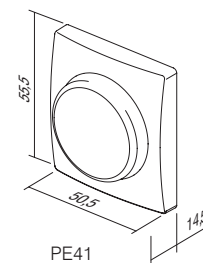

PE41

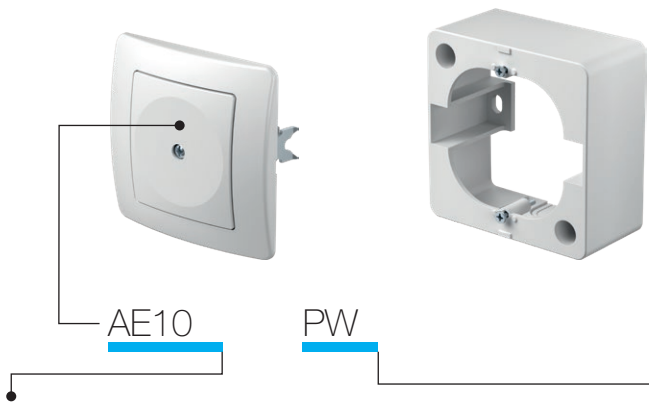

typ type	popis description	farba colour
AE10	VÝPLŇ BLANK	<input type="checkbox"/> PW polárna biela polar white
AE20	SPOJOVACIA SKRINKA 3P+N+E 5 x 4 mm ² CONNECTION BOX 3P+N+E 5x4mm ²	<input type="checkbox"/> IW slonová kosť ivory white
AE30	KRABICA PRE POVRCHOVÚ MONTÁŽ SURFACE MOUNT BOX	<input type="checkbox"/> ES strieborná matná elox silver
⋮	⋮	<input type="checkbox"/> CO biely duroplast white thermoset
⋮	⋮	<input type="checkbox"/> NB čierna lesklá night black

VÝPLŇ



- AE10PW
- AE10IW
- AE10ES
- AE10CO
- AE10NB

- na vyplnenie prázdnych miest
BLANK
- for filling up empty spaces



SPOJOVACIA KRABICA PÄŤPÓLOVÁ 3P+N+E 5 x 4 mm²



- AE20PW
- AE20IW

- 3P+N+E prípojka
- 16 A 400 V ~
- v súlade s normou VDE 0606-1:2000
- skrutkové upevnenie vodičov 1,5 až 4 mm²

CONNECTION BOX 5POLE 3P+N+E 5x4mm²
- 3P+N+E connection box
- 16A 400V ~
- in accordance with VDE 0606-1:2000
- screw contacts 1.5-4mm²



KRABICA PRE POVRCHOVÚ MONTÁŽ 1

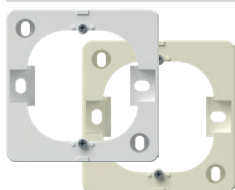

- AE30PW
- AE30IW

- krabica na povrchovú montáž
SURFACE MOUNT BOX 1
- surface mounting box



POVRCHOVÁ KRABICA PRE DVOJITÚ ZÁSUVKU EKONOMIK

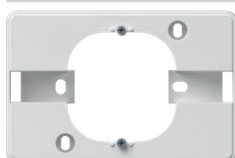

- AE31PW

- krabica na povrchovú montáž
SURFACE MOUNT BOX FOR
EKONOMIK DOUBLE SOCKET
- surface mounting box





- AE50PW
- AE50TS

CHRÁNIČ STENY

- chránič steny okolo vypínača alebo zásuvky

WALL PROTECTION

- protects surface around socket or switch

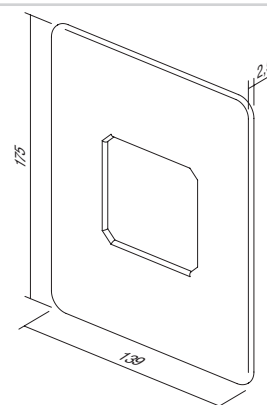

- AE51PW
- AE51IW

DETSKÁ OCHRANA KS

- KS detská ochrana pred dotykom s kontaktmi pod napätím

CHILD PROTECTION KS

- KS additional child protection insert - shuttered live contacts

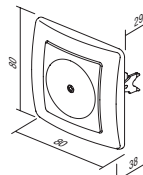
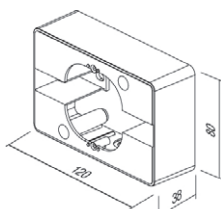
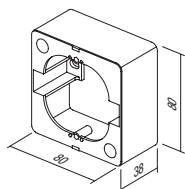
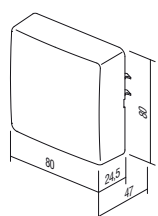
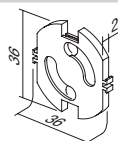

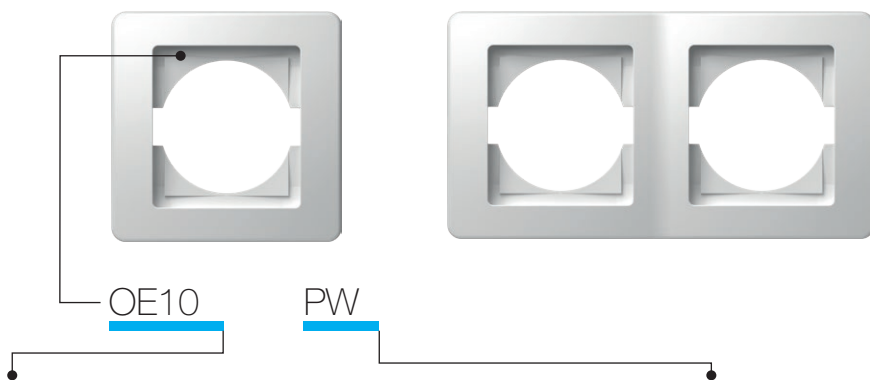

typ type	popis description	farba colour
OE10	RÁMIK EKONOMIK 1 SURROUND EKONOMIK 1	<input type="checkbox"/> PW polárna biela polar white
OE20	RÁMIK EKONOMIK 2 HORIZONTÁLNY SURROUND EKONOMIK 2 HORIZONTAL	<input type="checkbox"/> IW slonová kosť ivory white
OE30	RÁMIK EKONOMIK 3 HORIZONTÁLNY SURROUND EKONOMIK 3 HORIZONTAL	<input type="checkbox"/> ES strieborná matná elox silver
⋮	⋮	<input type="checkbox"/> CO biely duroplast white thermoset
⋮	⋮	<input type="checkbox"/> NB čierna lesklá night black



- OE10PW
- OE10IW
- OE10ES
- OE10CO
- OE10NB

RÁMIK EKONOMIK 1

- dekoratívny samostatný rámik
- v súlade s normou EN 60669-1

SURROUND EKONOMIK 1

- decorative surround 1-gang
- in accordance with EN 60669-1

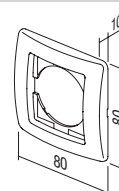

- OE20PW
- OE20IW
- OE20ES
- OE20CO
- OE20NB

RÁMIK EKONOMIK 2 HORIZONTÁLNY

- dekoratívny 2-rámik horizontálny
- v súlade s normou EN 60669-1

SURROUND EKONOMIK 2 HORIZONTAL

- decorative surround 2-gang horizontal
- in accordance with EN 60669-1

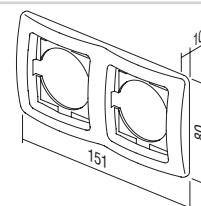

- OE21PW
- OE21IW
- OE21ES
- OE21CO
- OE21NB

RÁMIK EKONOMIK 2 VERTIKÁLNY

- dekoratívny 2-rámik vertikálny
- v súlade s normou EN 60669-1

SURROUND EKONOMIK 2 VERTICAL

- decorative surround 2-gang vertical
- in accordance with EN 60669-1

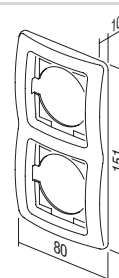

- OE30PW
- OE30IW
- OE30ES
- OE30CO
- OE30NB

RÁMIK EKONOMIK 3 HORIZONTÁLNY

- dekoratívny 3-rámik horizontálny
- v súlade s normou EN 60669-1

SURROUND EKONOMIK 3 HORIZONTAL

- decorative surround 3-gang horizontal
- in accordance with EN 60669-1

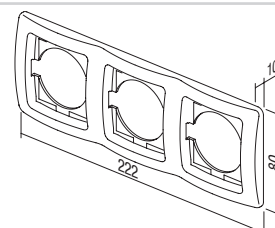



- OE31PW
- OE31IW
- OE31ES
- OE31CO
- OE31NB

RÁMIK EKONOMIK 3 VERTIKÁLNY

- dekoratívny 3-rámik vertikálny
- v súlade s normou EN 60669-1

SURROUND EKONOMIK 3 VERTICAL

- decorative surround 3-gang vertical
- in accordance with EN 60669-1

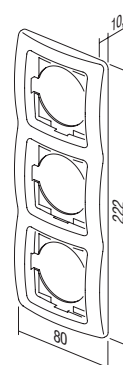

- OE40PW
- OE40IW
- OE40ES
- OE40NB

RÁMIK EKONOMIK 4 HORIZONTÁLNY

- dekoratívny 4-rámik horizontálny
- v súlade s normou EN 60669-1

SURROUND EKONOMIK 4 HORIZONTAL

- decorative surround 4-gang horizontal
- in accordance with EN 60669-1

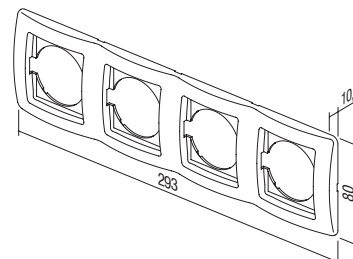

- OE41PW
- OE41IW
- OE41ES
- OE41NB

RÁMIK EKONOMIK 4 VERTIKÁLNY

- dekoratívny 4-rámik vertikálny
- v súlade s normou EN 60669-1

SURROUND EKONOMIK 4 VERTICAL

- decorative surround 4-gang vertical
- in accordance with EN 60669-1

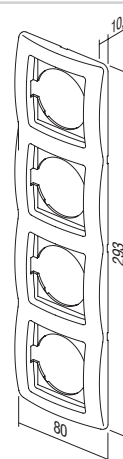

- OE50PW
- OE50IW
- OE50ES
- OE50NB

RÁMIK EKONOMIK 5 HORIZONTÁLNY

- dekoratívny 5-rámik horizontálny
- v súlade s normou EN 60669-1

SURROUND EKONOMIK 5 HORIZONTAL

- decorative surround 5-gang horizontal
- in accordance with EN 60669-1

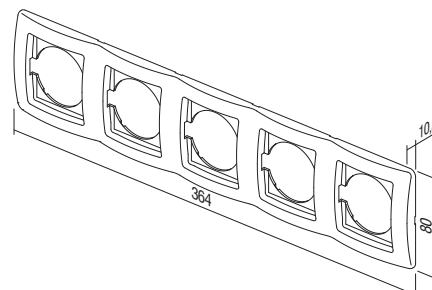

DEKORATÍVNE RÁMIKY COLOUR /
COLOR DECORATIVE FRAMES

OE90GR ZELENÁ /
GREEN
OE90BL MODRÁ /
BLUE
OE90VO FIALOVÁ /
VIOLET
OE90PI RUŽOVÁ /
PINK
OE90RD ČERVENÁ /
RED

OE90YL ŽLTÁ /
YELLOW
OE90WH BIELA /
WHITE
OE90GY SIVÁ /
GREY
OE90BK ČIERNA /
BLACK

OE90MB METALICKÁ MODRÁ /
MET. BLUE
OE90BZ BRONZOVÁ /
BRONZE
OE90CR STRIEBORNÁ /
SILVER
OE90GO ZLATÁ /
GOLD



TEM



KATALÓG / CATALOGUE

fontana



SPÍNAČE SF

SWITCHES SF

218

ZÁSUVKY VF

SOCKETS VF

220

SÚPRAVY CF

SETS CF

221

PRÍSLUŠENSTVO AF

ACCESSORIES AF

223

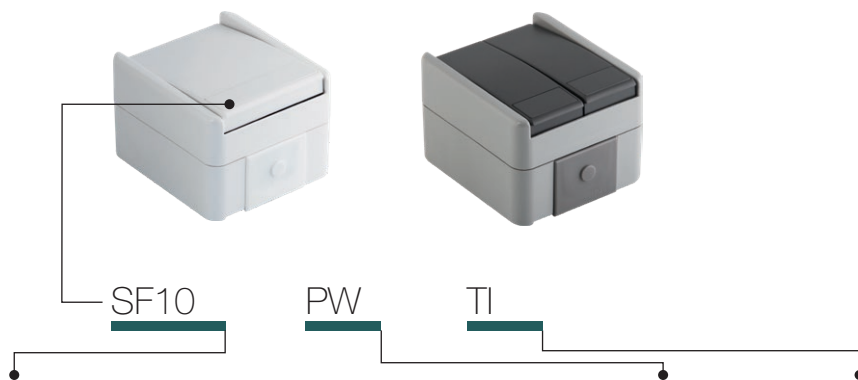

typ type	popis description	technické údaje technical data	farba colour	voliteľné údaje 1 optional data 1
SF10	SPÍNAČ JEDNOPÓLOVÝ SWITCH 1WAY	IP44 10AX 250V~	<input type="checkbox"/> PW biela – matná white-mat	TI tlejkva + indikátor neon lamp+indication
SF11	TLAČIDLO JEDNOPÓLOVÉ PUSH BUTTON 1WAY	IP44 10A 250V~	<input type="checkbox"/> GY sivá – matná grey-mat	
SF20	SPÍNAČ DVOJPÓLOVÝ SWITCH 2POLE	IP44 10AX 250V~		
:	:	:		

SPÍNAČ JEDNOPÓLOVÝ IP44 10 AX 250 V ~



- SF10PW
- SF10GY

- 10 AX 250 V ~, typ SF10
 - v súlade s normou EN 60669-1
 - bezskrútkové upevnenie vodičov 1,5 – 2,5 mm²
 SWITCH 1WAY IP44 10AX 250V~
 - 10AX 250V~, type SF10
 - in accordance with EN 60669-1
 - plug-in contacts 1.5-2.5mm²



SPÍNAČ JEDNOPÓLOVÝ IP44 10 AX 250 V ~ __ TI



- SF10PWTI
- SF10GYTI

- TI indikátor + tlejkva
 - 10 AX 250 V ~, typ SF10
 - v súlade s normou EN 60669-1
 - bezskrútkové upevnenie vodičov 1,5 – 2,5 mm²
 SWITCH 1WAY IP44 10AX 250V~ __ TI
 - TI indicator+neon lamp
 - 10AX 250V~, type SF10
 - in accordance with EN 60669-1
 - plug-in contacts 1.5-2.5mm²



TLAČIDLO JEDNOPÓLOVÉ IP44 10 A 250 V ~ __ TI



- SF11PWTI
- SF11GYTI

- TI indikátor + tlejkva
 - 10 A 250 V ~, typ SF11
 - v súlade s normou EN 60669-1
 - bezskrútkové upevnenie vodičov 1,5 – 2,5 mm²
 PUSH BUTTON 1WAY IP44 10A 250V~ __ TI
 - TI indicator+neon lamp
 - 10A 250V~, type SF11
 - in accordance with EN 60669-1
 - plug-in contacts 1.5-2.5mm²



SPÍNAČ DVOJPÓLOVÝ IP44 10 AX 250 V ~



- SF20PW
- SF20GY

- 10 AX 250 V ~, typ SF20
 - v súlade s normou EN 60669-1
 - bezskrútkové upevnenie vodičov 1,5 – 2,5 mm²
 SWITCH 2POLE IP44 10AX 250V~
 - 10AX 250V~, type SF20
 - in accordance with EN 60669-1
 - plug-in contacts 1.5-2.5mm²



SPÍNAČ SÉRIOVÝ IP44 10 AX 250 V ~



- SF50PW
- SF50GY

- 10 AX 250 V ~, typ SF50
 - v súlade s normou EN 60669-1
 - bezskrútkové upevnenie vodičov 1,5 – 2,5 mm²

SWITCH 2GANG-1WAY IP44 10AX 250V~

- 10AX 250V~, type SF50
 - in accordance with EN 60669-1
 - plug-in contacts 1.5-2.5mm²



TLAČIDLO SÉRIOVÉ IP44 10 A 250 V ~



- SF51PW
- SF51GY

- 10 A 250 V ~, typ SF51
 - v súlade s normou EN 60669-1
 - bezskrútkové upevnenie vodičov 1,5 – 2,5 mm²

PUSH BUTTON 2GANG-1WAY IP44 10A 250V~

- 10A 250V~, type SF51
 - in accordance with EN 60669-1
 - plug-in contacts 1.5-2.5mm²



STRIEDAVÝ PREPÍNAČ IP44 10 AX 250 V ~



- SF60PW
- SF60GY

- 10 AX 250 V ~, typ SF60
 - v súlade s normou EN 60669-1
 - bezskrútkové upevnenie vodičov 1,5 – 2,5 mm²

SWITCH 2WAY IP44 10AX 250V~

- 10AX 250V~, type SF60
 - in accordance with EN 60669-1
 - plug-in contacts 1.5-2.5mm²



STRIEDAVÝ PREPÍNAČ IP44 10 AX 250 V ~ __ TI



- SF60PWTI
- SF60GYTI

- TI indikátor + neónová lamp
 - 10 AX 250 V ~, typ SF60
 - v súlade s normou EN 60669-1
 - bezskrútkové upevnenie vodičov 1,5 – 2,5 mm²

SWITCH 2WAY IP44 10AX 250V~ __ TI

- TI indicator+neon lamp
 - 10AX 250V~, type SF60
 - in accordance with EN 60669-1
 - plug-in contacts 1.5-2.5mm²



STRIEDAVÝ PREPÍNAČ DVOJITÝ IP44 10 AX 250 V ~



- SF63PW
- SF63GY

- 10 AX 250 V ~, typ SF63
 - v súlade s normou EN 60669-1
 - bezskrútkové upevnenie vodičov 1,5 – 2,5 mm²

SWITCH 2WAY DOUBLE IP44 10AX 250V~

- 10AX 250V~, type SF63
 - in accordance with EN 60669-1
 - plug-in contacts 1.5-2.5mm²



KRÍŽOVÝ PREPÍNAČ IP44 10 AX 250 V ~



- SF70PW
- SF70GY

- 10 AX 250 V ~, typ SF70
 - v súlade s normou EN 60669-1
 - bezskrútkové upevnenie vodičov 1,5 – 2,5 mm²

SWITCH INTERMEDIATE IP44 10AX 250V~

- 10AX 250V~, type SF70
 - in accordance with EN 60669-1
 - plug-in contacts 1.5-2.5mm²

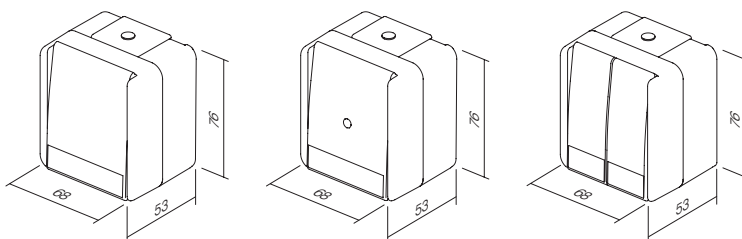

Z Á S U V K Y V F S O C K E T S

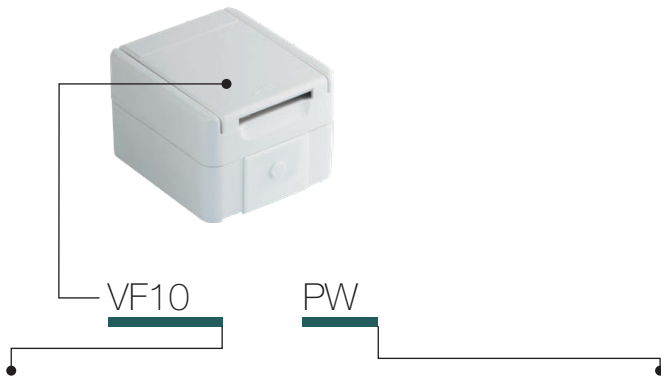

typ type	popis description	technické dáta technical data	farba colour
VF10	ZÁSUVKA SCHUKO + KRYT SOCKET SCHUKO+COVER	IP44 2P+E 16A 250V~	<input type="checkbox"/> PW biela – matná white-mat <input type="checkbox"/> GY sivá – matná grey-mat

ZÁSUVKA SCHUKO + KRYT IP44 2P+E 16 A 250 V ~



- VF10PW
- VF10GY

- skrutkové upevnenie vodičov 1,5 – 2,5 mm²
- 2P + E schuko + kryt
- 16 A 250 V ~, typ VF10
- v súlade s normami EN 60884-1, CEE7

SOCKET SCHUKO+COVER IP44 2P+E 16A 250V~

- screw contacts 1.5-2.5mm²
- 2P+E schuko+cover
- 16A 250V~, type VF10
- in accordance with EN 60884-1, CEE7



ZÁSUVKA SCHUKO + KRYT IP44 2P+E 16 A 250 V ~ BV



- VF12PW
- VF12GY

- BV bezskrutkové upevnenie vodičov 1,5 – 2,5 mm²
- 2P + E schuko + kryt
- 16 A 250 V ~, typ VF12
- v súlade s normami EN 60884-1, CEE7

SOCKET SCHUKO+COVER IP44 2P+E 16A 250V~ BV

- BV plug-in contacts 1.5-2.5mm²
- 2P+E schuko+cover
- 16A 250V~, type VF12
- in accordance with EN 60884-1, CEE7

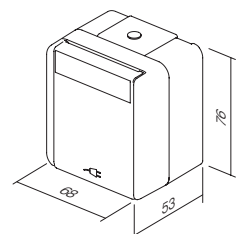

SF10
SF60

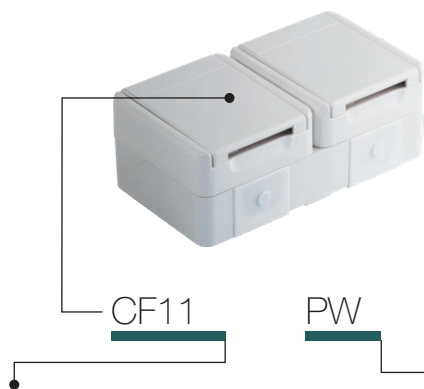

typ type	popis description	technické dáta technical data	farba colour
CF10	SÚPRAVA ZÁSUVIEK SCHUKO DVOJITÁ HORIZONT. SOCKET SET SCHUKO DOUBLE HORIZ	2x 2P+E 16A 250V~ IP44	<input type="checkbox"/> PW biela – matná white-mat
CF11	SÚPRAVA ZÁSUVIEK SCHUKO DVOJITÁ VERTIK. SOCKET SET SCHUKO DOUBLE VERT	2x 2P+E 16A 250V~ IP44	<input checked="" type="checkbox"/> GY sivá – matná grey-mat
CF12	ZÁSUVKA SCH + DVOJPÓLOVÝ VYPÍNAČ HORIZONT. SOCKET SCH+SWITCH 2WAY HORIZ	16A + 10A 250V~ IP44	
⋮	⋮	⋮	
⋮	⋮	⋮	



- CF10PW
 CF10GY

SÚPRAVA ZÁSUVIEK SCHUKO DVOJITÁ HORIZONTÁLNA IP44 2x 2P+E 16 A 250 V ~

- skrutkové upevnenie vodičov 1,5 – 2,5 mm²
- 2x 2P+E schuko + kryt horizontálny
- 16 A 250 V ~, typ CF10
- v súlade s normami EN 60884-1, CEE7

SOCKET SET SCHUKO DOUBLE HORIZONTAL IP44 2x 2P+E 16A 250V~

- screw contacts 1.5-2.5mm²
- 2x 2P+E schuko+cover horizontal
- 16A 250V~, type CF10
- in accordance with EN 60884-1, CEE7



- CF11PW
 CF11GY

SÚPRAVA ZÁSUVIEK SCHUKO DVOJITÁ VERTIKÁLNA IP44 2x 2P+E 16 A 250 V ~

- skrutkové upevnenie vodičov 1,5 – 2,5 mm²
- 2x 2P+E schuko + kryt vertikálny
- 16 A 250 V ~, typ CF11
- v súlade s normami EN 60884-1, CEE7

SOCKET SET SCHUKO DOUBLE VERTICAL IP44 2x 2P+E 16A 250V~

- screw contacts 1.5-2.5mm²
- 2x 2P+E schuko+cover vertical
- 16A 250V~, type CF11
- in accordance with EN 60884-1, CEE7



- CF12PW
 CF12GY

ZÁSUVKA SCH + DVOJPÓLOVÝ SPÍNAČ HORIZONTÁLNY IP44 16 A + 10 AX 250 V ~

- skrutkové (zásuvka), bezskrutkové (spínač) upevnenie 1,5 – 2,5 mm²
- 2P+E schuko + kryt + spínač dvojsmerný horizontálny
- 16 A + 10 AX 250 V ~, typ CF12
- v súlade s normami EN 60884-1, CEE7, EN 60669-1

SOCKET SCH+SWITCH SET 2WAY HORIZONTAL IP44 16A + 10AX 250V~

- screw (socket), plug-in (switch) contacts 1.5-2.5mm²
- 2P+E schuko+cover + switch 2-way horizontal
- 16A + 10AX 250V~, type CF12
- in accordance with EN 60884-1, CEE7, EN 60669-1



ZÁSUVKA SCH + SÚPRAVA DVOJPÓLOVÝCH SPÍNAČOV VERTIKÁLNA IP44 16A + 10 AX 250V ~



- CF13PW
- CF13GY

- skrutkové (zásuvka), bezskrutkové (spínač) upevnenie 1,5 – 2,5 mm²
- 2P+E schuko + kryt + spínač dvojsmerný vertikálny
- 16 A + 10 AX 250 V ~, typ CF13
- v súlade s normami EN 60884-1, CEE7, EN 60669-1

SOCKET SCH+SWITCH 2WAY SET VERTICAL IP44 16A + 10AX 250V~

- screw (socket), plug-in (switch) contacts 1.5-2.5mm²
- 2P+E schuko+cover + switch 2-way vertical
- 16A + 10AX 250V~, type CF13
- in accordance with EN 60884-1, CEE7, EN 60669-1



SÚPRAVA ZÁSUVIEK SCHUKO DVOJITÁ HORIZONTÁLNA IP44 2x 2P+E 16 A 250 V ~ BV



- CF14PW
- CF14GY

- BV bezskrutkové upevnenie vodičov 1,5 – 2,5 mm²
- 2 x 2P+E schuko + kryt horizontálny
- 16 A 250 V ~, typ CF14
- v súlade s normami EN 60884-1, CEE7

SOCKET SET SCHUKO DOUBLE HORIZONTAL IP44 2x 2P+E 16A 250V~ BV

- BV plug-in contacts 1.5-2.5mm²
- 2x 2P+E schuko+cover horizontal
- 16A 250V~, type CF14
- in accordance with EN 60884-1, CEE7



SÚPRAVA ZÁSUVIEK SCHUKO DVOJITÁ VERTIKÁLNA IP44 2x 2P+E 16 A 250 V ~ BV



- CF15PW
- CF15GY

- BV bezskrutkové upevnenie vodičov 1,5 – 2,5 mm²
- 2 x 2P+E schuko + kryt vertikálny
- 16 A 250 V ~, typ CF15
- v súlade s normami EN 60884-1, CEE7

SOCKET SET SCHUKO DOUBLE VERTICAL IP44 2x 2P+E 16A 250V~ BV

- BV plug-in contacts 1.5-2.5mm²
- 2x 2P+E schuko+cover vertical
- 16A 250V~, type CF15
- in accordance with EN 60884-1, CEE7



ZÁSUVKA + SÚPRAVA SPÍNAČOV + DVOJPÓLOVÉ HORIZONTÁLNE IP44 16A + 10 AX 250 V ~ BV



- CF16PW
- CF16GY

- BV bezskrutkové upevnenie vodičov 1,5 – 2,5 mm²
- 2P+E schuko + kryt + spínač dvojsmerný horizontálny
- 16 A + 10 AX 250 V ~, typ CF16
- v súlade s normami EN 60884-1, CEE7, EN 60669-1

SOCKET+SWITCH SET SCH+2WAY HORIZONTAL IP44 16A + 10AX 250V~ BV

- BV plug-in contacts 1.5-2.5mm²
- 2P+E schuko+cover + switch 2-way horizontal
- 16A + 10AX 250V~, type CF16
- in accordance with EN 60884-1, CEE7, EN 60669-1



ZÁSUVKA + SÚPRAVA SPÍNAČOV + DVOJPÓLOVÉ VERTIKÁLNE IP44 16A + 10 AX 250 V ~ BV



- CF17PW
- CF17GY

- BV bezskrutkové upevnenie vodičov 1,5 – 2,5 mm²
- 2P+E schuko + kryt + vypínač dvojsmerný vertikálny
- 16 A + 10 AX 250 V ~, typ CF17
- v súlade s normami EN 60884-1, CEE7, EN 60669-1

SOCKET SCH+SWITCH 2WAY SET VERTICAL IP44 16A + 10AX 250V~ BV

- BV plug-in contacts 1.5-2.5mm²
- 2P+E schuko+cover + switch 2-way vertical
- 16A + 10AX 250V~, type CF17
- in accordance with EN 60884-1, CEE7, EN 60669-1



PRÍSLUŠENSTVO A F ACCESSORIES

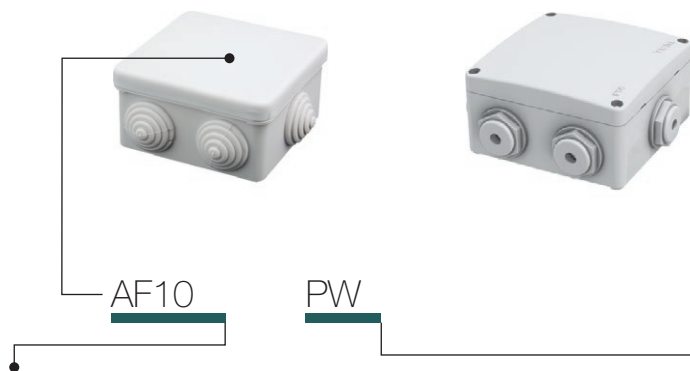

typ type	popis description	technické dáta technical data	farba colour
AF10	ROZVODNÁ KRABICA DISTRIBUTION BOX	IP44 RN01	<input type="checkbox"/> PW biela – matná white-mat
AF20	ROZVODNÁ KRABICA DISTRIBUTION BOX	IP55 NDO1	<input checked="" type="checkbox"/> GY sivá – matná grey-mat

ROZVODNÁ KRABICA IP44 RN01



- AF10PW
- AF10GY

- rozvodná krabica s montážou na povrchu IP44
- 16 A 400 V ~
- v súlade s normou IEC/EN 60670-1, IEC/EN 60670-22

DISTRIBUTION BOX IP44 RN01

- surface mounting distribution box IP44
- 16A 400V~
- in accordance with IEC/EN 60670-1, IEC/EN 60670-22

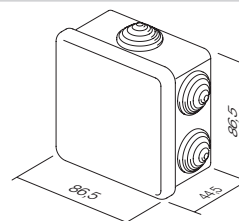

ROZVODNÁ KRABICA IP55 ND01



- AF20PW
- AF20GY

- spojovacia krabica s montážou na povrchu IP55
- priečhodky priložené
- v súlade s normou IEC/EN 60670-1, IEC/EN 60670-22

DISTRIBUTION BOX IP55 ND01

- surface mounting connection box IP55
- glands included
- in accordance with IEC/EN 60670-1, IEC/EN 60670-22

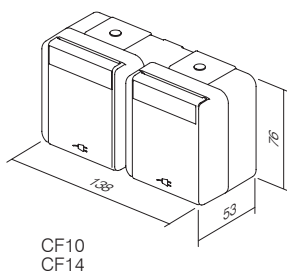
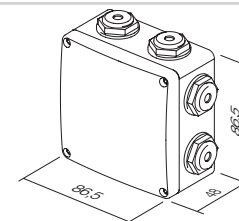

CF10
CF14

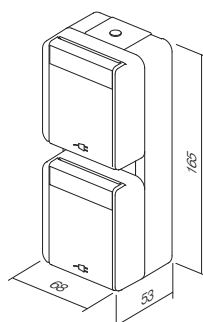

CF11
CF15

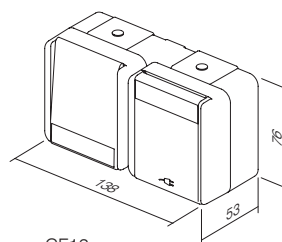

CF12
CF16

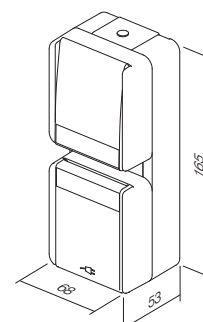

CF13
CF17

MODUL

kód	popis výrobku	strana	kód	popis výrobku	strana
SPÍNAČE SM			KOMUNIKÁCIE KM		
SM10	SPÍNAČ JEDNOPÓLOVÝ 16 AX 250 V ~ 1M	68	KM10-	ZÁSUVKA TV ZÁKLADNÁ 0 dB 1M	82
SM11	TLAČIDLO JEDNOPÓLOVÉ 16 A 250 V ~ 1M	68	KM20-	ZÁSUVKA TV ZÁKLADNÁ 0 dB 2M	82
SM12	SPÍNAČ JEDNOPÓLOVÝ 20A 250 V ~ 1M	68	KM11-	ZÁSUVKA TV KONCOVÁ 1 dB 1M	82
SM20	SPÍNAČ DVOJPÓLOVÝ 16 AX 250 V ~ 1M	68	KM12-	ZÁSUVKA TV PRIEBEŽNÁ 10 dB 1M	82
SM40	ŽALÚZIOVÝ SPÍNAČ 1-0-2 16 AX 250 V ~ 1M	69	KM15-	ZÁSUVKA SAT ZÁKLADNÁ 0 dB 1M	83
SM41	ŽALÚZIOVÉ TLAČIDLO 1-0-2 16 A 250 V ~ 1M	69	KM24-	ZÁSUVKA SAT ZÁKLADNÁ 0 dB 2M	83
SM60	STRIEDAVÝ PREPÍNAČ 16 AX 250 V ~ 1M	69	KM16-	ZÁSUVKA SAT KONCOVÁ 1dB 1M	83
SM61	STRIEDAVÉ TLAČIDLO 16 A 250 V ~ 1M	69	KM19-	ZÁSUVKA R ZÁKLADNÁ 0 dB 1M	83
SM70	KRÍŽOVÝ PREPÍNAČ 16 AX 250 V ~ 1M	69	KM29-	ZÁSUVKA R ZÁKLADNÁ 0 dB 2M	83
SM10-	SPÍNAČ JEDNOPÓLOVÝ 16 AX 250 V ~ 1M	70	KM25-	ZÁSUVKA SAT-TV KONCOVÁ 1 dB 2M	83
SM10-IN	SPÍNAČ JEDNOPÓLOVÝ 16 AX 250 V ~ 1M IN	70	KM22-	ZÁSUVKA AUDIO 2 x RCA 1M	84
SM11-	TLAČIDLO JEDNOPÓLOVÉ 16 A 250 V ~ 1M	70	KM23-	ZÁSUVKA AUDIO REPRODUKTOROVÁ 1M	84
SM11-IN01	TLAČIDLO JEDNOPÓLOVÉ 16 A 250 V ~ 1M IN 01	70	KM26-	ZÁSUVKA AUDIO REPRODUKTOROVÁ 2M	84
SM11-IN02	TLAČIDLO JEDNOPÓLOVÉ 16 A 250 V ~ 1M IN 02	71	KM30-	ZÁSUVKA TEL LT RJ11 6/4 1M	85
SM20-NT03	SPÍNAČ DVOJPÓLOVÝ 16 AX 250 V ~ 1M NT 03	71	KM31-	ZÁSUVKA TEL BT SEC 6/6 1M	85
SM20-IN	SPÍNAČ DVOJPÓLOVÝ 16 AX 250 V ~ 1M IN	71	KM36-	ZÁSUVKA TEL KS RJ11 6/4 1M	85
SM40-NT10	ŽALÚZIOVÝ SPÍNAČ 1-0-2 16 AX 250 V ~ 1M NT 10	71	KM37-	ZÁSUVKA KAT. 5e KS RJ45 8/8 1M	85
SM41-NT10	ŽALÚZIOVÉ TLAČIDLO 1-0-2 16 A 250 V ~ 1M NT 10	71	KM35-	ADAPTÉR KS 1M	85
SM60-	STRIEDAVÝ PREPÍNAČ 16 AX 250 V ~ 1M	71	KM38-	ADAPTÉR KS S OCHRANOU PROTI PRACHU 1M	86
SM61-	STRIEDAVÉ TLAČIDLO 16 A 250 V ~ 1M	72	KM39-	ZÁSUVKA KS KAT. 6 SCH RJ45 8/8 1M	86
SM62-CD	STRIEDAVÉ TLAČIDLO S TIAHLOM 16 A 250V ~ 1M CD	72	KM50-	ADAPTÉR KS UNIVERZÁLNY 1M	86
SM70-	KRÍŽOVÝ PREPÍNAČ 16 AX 250 V ~ 1M	72	KM40-	ADAPTÉR PD 1M	86
TLAČIDLÁ TM			KM43-	ADAPTÉR PD S OCHRANOU PROTI PRACHU 1M	86
TM11-	KRYT TLAČIDLA 1M	73	KM46-	ADAPTÉR R&M 1M	86
TM11-IN	KRYT TLAČIDLA S INDIKÁTOROM 1M	73	KM52-	ADAPTÉR CAT6A 1M ZNAČKY R&M	86
TM12-	KRYT TLAČIDLA 2M	73	KM47-	ADAPTÉR R&M S OCHRANOU PROTI PRACHU 1M	87
TM12-IN	KRYT TLAČIDLA S INDIKÁTOROM 2M	73	KM53-	ADAPTÉR R&M CAT6A S OCHRANOU PROTI PRACHU 1M	87
TM13-IL	KRYT NA SPÍNAČ S POPISNÝM ŠTÍTKOM	74	KM45-	ADAPTÉR LK 1M	88
TM15-	KRYT NA SPÍNAČ DVOJPÓLOVÝ	74	KA26	ADAPTÉR NEXSANS/SCHRACK 2M	88
TM21-	VÝPLŇ 1M	74	KM48-	ADAPTÉR AT&T SYSTMIX S OCHRANOU PROTI PRACHU 1M	88
TM22-	VÝPLŇ 2M	74	KM51-	USB ZÁSUVKA TYPU A 1M	88
TM31-	KÁBLOVÁ PRECHODKA 1M	74	KOMUNIKAČNÉ PRÍSLUŠENSTVO KA		
INDIKÁCIA IA			KA10	KONEKTOR KS KAT. 3 RJ11 6/4	89
IA10-	TLEJIVKA 230 V ~ 0,34 W	76	KA11	KONEKTOR KS KAT. 5e RJ45 8/8	89
IA20-	LED DIÓDA 230V AC/DC 0,40W	76	KA12	KONEKTOR KS KAT. 5eS RJ45 8/8	89
IA21-	LED DIÓDA 24V AC/DC 0,20W	76	KA15	KONEKTOR KS KAT. 6 SCHRACK RJ45 8/8	89
IA22-	LED DIÓDA 12V AC/DC 0,10W	76	KA16	KONEKTOR KS KAT. 6S SCHRACK RJ45 8/8	89
IA50	RC OBYVOD 250V ~	76	KA17	KONEKTOR KS KAT. 6a SCHRACK RJ45 8/8	89
ZÁSUVKY VM			KA18	KONEKTOR SLIM KS KAT. 6S SCHRACK RJ45 8/8	90
VM10-	ZÁSUVKA SCHUKO + KS 2P+E 16 A 250V ~ 2M	78	KA27	KONEKTOR KS HDMI	90
VM11-	ZÁSUVKA SCHUKO + KS + KRYT 2P+E 16 A 250 V ~ 2M	78	KA28	KÁBEL KS HDMI	90
VM20-	ZÁSUVKA EURO + KS 2P 10 A 250 V ~ 1M	79	ELEKTRONIKA EM		
VM40-	FRANCÚZSKA ZÁSUVKA +KS 2P+E 16 A 250 V ~ 2M	79	EM10-	STMIEVAČ ROTAČNÝ R 300 W 1M	91
VM41-	FRANCÚZSKA ZÁSUVKA + KS + KRYT 2P+E 16 A 250 V ~ 2M	79	EM12-	STMIEVAČ ROTAČNÝ/STRIEDAVÝ RL 300 W 1M	91
VM30-	TALIANSKA ZÁSUVKA P17/11 + KS 2P + E 16 A 250 V ~ 1M	79	EM13-	STMIEVAČ ROTAČNÝ/STRIEDAVÝ LED 60 W 1M	92
VM31-	ZÁSUVKA SCHUKO/ITA P17/11+KS 2P+E 16 A 250 V ~ 2M	79	EM14-	STMIEVAČ ROTAČNÝ/STRIEDAVÝ LED 180 W 1M	92
VM32-	ZÁSUVKA SCHUKO/ITA P30+KS 2P+E 16 A 250 V ~ 2M	80	EM15-	STMIEVAČ ROTAČNÝ R 250 W 1M	92
VM33-	TALIANSKA ZÁSUVKA P11+KS 2P+E 10 A 250 V ~ 1M	80	EM23	ZABUDOVATELNÝ STMIEVAČ R (250 W), (EC, RL 200 VA)	93
VM21-	EURÓPSKA/AMERICKÁ ZÁSUVKA + KS 2P 16 A 250 V ~ 1M	80	EM18	ZABUDOVATELNÝ STMIEVAČ LED 250W	93
VM51-	BRITSKÁ ZÁSUVKA BS546+KS 2P+E 15A 250 V ~ 2M	80	EM19	ZABUDOVATELNÝ STMIEVAČ DC LED 96W	93
VM52-	BRITSKÁ ZÁSUVKA BS 1363-2 + KS 2P + E 13A 250 V ~ 2M	80	EM25-	UNIVERZÁLNY STMIEVAČ RLC 0-300 W 2M	95
VM80	PREPÄTOVÁ OCHRANA MPE MINI 275 W/50 Hz	80	EM26-	OVLÁDACIA JEDNOTKA STMIEVAČA 2M	97
			EM27	FREKVENČNÝ FILTER	97
			EM25PPOL20	UNIVERZÁLNY STMIEVAČ RLC 0-300 W 2M PP OL20	97
			EM31-	IR SPÍNAČ 5 A 230 V ~ 1M	98
			EM32-	IR SPÍNAČ 5 A 230 V ~ 2M	98
			EM37-	TERMOSTAT ZÁKLADNÝ 6 A 230 V ~ 2M	100
			NM39	MONTÁŽNY RÁMIK SO SKRUTKAMI PRE TERMOSTATY FANTINI COSMI 3M	101
			EM40-	KARTOVÝ SPÍNAČ JEDNOTKY PRE ÚSPORU ENERGIE 3A 250 V ~ 3M	101
			EM47	KARTA ISO	101
			EM44-	KARTOVÝ SPÍNAČ JEDNOTKY PRE ÚSPORU ENERGIE RF HF 13,56MHz 3M	102
			EM49	OVLÁDAČ JEDNOTKY PRE ÚSPORU ENERGIE 2 x 16A 250 V~	102
			EM45	ROZDELOVAČ SPL-1	102
			EM60-	ZÁSUVKA NA HOLIACI STROJČEK 230 V~/120V~ 3M	103
			EM66-	NABÍJACIA JEDNOTKA USB 5 V 2,1 A 1M	103
			EM65-	NABÍJACIA JEDNOTKA USB 5 V 1 A 2M	103
			EM67-	NABÍJACIA JEDNOTKA USB 5V 2,4A 1M	104
			EM55	LED NÚDZOVÉ OSVETLENIE 250 V ~ 0,9W, NiCd 3h 7M	104
			EM57	LED NÚDZOVÉ OSVETLENIE 230 V ~ 0,5W, NiMH 2 h 2M	104
			EM50-	SVIETIDLO LED JEDNOFAREBNÉ 250 V ~ 0,8 W 2M	105
			EM51-	SVIETIDLO LED DVOJFAREBNÉ 250 V ~ 2 x 0,4 W 2M	105
			EM52-	3D SVIETIDLO LED DVOJFAREBNÉ 250 V ~ 2 x 0,4 W 2M	105
			EM71-	SPÍNAČ NA ODTLAČKY PRSTOV BIOPASS 2M	106
			EM80-	BEZDOTYKOVÝ SPÍNAČ 10 A 240 V ~	107
			EM81-	BEZDOTYKOVÝ SPÍNAČ, OVLÁDACIA JEDNOTKA	107
			EM90-	BZUČIAK 8 VA 230 V ~ 1M	108
			EM91-	BZUČIAK 8 VA 12 V ~ 1M	108
			EM92-	ZVONČEK 8 VA 230 V ~ 1M	108
			EM93-	ZVONČEK 8 VA 12 V ~ 1M	108
			EM95-	REGULÁTOR HLASISTOSTI 100 V 35 W 2M	109
			EM96-	REGULÁTOR HLASISTOSTI NÍZKONAPŔTOVÝ 4-8 Ω 35 W 2M	109

K R A B I C E

kód	popis výrobku	strana	kód	popis výrobku	strana
SETI CM			OKRÚHLA KRABICE		
CM10-	SADA ZÁSUVIEK 2x SCHUKO 2P+E 16A 250V ~ 4M	110	DE10	OKRÚHLA KRABICA DO STENY SM60-01	140
CM11-	SADA ZÁSUVIEK 3x SCHUKO 2P+E 16A 250V ~ 7M	110	DE11	OKRÚHLA KRABICA DO STENY HLBOKÁ SM60-06	140
CM15	SÚPRAVA PREPOJOVACÍCH PRVKOV 3 x 1,5 mm ² 1M	111	DE30	SPOJOVACÍ ČLÁNOK NA KRABICE DO STENY SM60-03	140
CM16	SÚPRAVA PREPOJOVACÍCH PRVKOV 3 x 2,5 mm ² 2M	111	DE31	SPOJOVACÍ ČLÁNOK NA KRABICE DO STENY SM60-04	140
CM17	SÚPRAVA SKRUTIEK 3,5 x 20	111	DE12	OKRÚHLA KRABICA DO STENY MD65-46	141
CM18	SÚPRAVA SKRUTIEK 3,5 x 35	111	DE13	OKRÚHLA KRABICA DO STENY HLBOKÁ MD65-60	141
CM19	SÚPRAVA SKRUTIEK 3,5 x 50	111	DE14	PREHLBENIE PRE MD65-46	141
CM22-	SADA IP 44 PRE SPÍNAČE 2M	111	DE32	SPOJOVACÍ ČLÁNOK NA KRABICE DO STENY MD65-71	141
CM23-	SADA IP44 PRE ZÁSUVKY 2M	111	DE33	SPOJOVACÍ ČLÁNOK NA KRABICE DO STENY MD65-91	141
CM25-OL	SÚPRAVA SPÍNAČOV DO KÚPELNE 3x 20A 250V ~ 4M OL	111	DE20	OCHRANNÝ KRYT KRABICE 60	141
CM25-OS	SÚPRAVA SPÍNAČOV DO KÚPELNE 3x 20A 250V ~ 4M OS	111	DE21	OCHRANNÝ KRYT KRABICE 65	141
NM41	MONTÁŽNY RÁM PRE KÚPEĽNÉ SADY 4M	112	DE22	KRYT KRABICE SM60	141
OL41-	RÁMIK PRE KÚPEĽNOVÚ SADU LINE	112	HE10	OKRÚHLA KRABICA - DUTÁ PRIEČKA SM68x40	144
OS41-	RÁMIK PRE KÚPEĽNOVÚ SADU SOFT	112	HE11	OKRÚHLA KRABICA - DUTÁ PRIEČKA SM68x55	144
ANTIBAKTERIÁLNY PROGRAM AW			BE10	OKRÚHLA KRABICA - BETÓN 60-49	144
TM11AW	KRYT TLAČIDLA 1M	115	BE11	OKRÚHLA KRABICA - BETÓN HLBOKÁ 60-77	144
TM11AWIN	KRYT TLAČIDLA S INDIKÁTOROM 1M	115	BE20	MONTÁŽNY RÁM KRABICE DO BETÓNU	144
TM12AW	KRYT TLAČIDLA 2M	115	BE21	PRIECHODKA KRABICE DO BETÓNU 16	144
TM12AWIN	KRYT TLAČIDLA S INDIKÁTOROM 2M	115	OBĽŽNIKOVÉ KRABICE		
TM21AW	VÝPLŇ 1M	115	DM30	OBĽŽNIKOVÁ KRABICA DO STENY PM3	148
TM22AW	VÝPLŇ 2M	115	DM31	OBĽŽNIKOVÁ KRABICA DO STENY PM3-65	148
VM10AW	ZÁSUVKA SCHUKO + KS 2P+E 16 A 250V ~ 2M	116	DM40	OBĽŽNIKOVÁ KRABICA DO STENY PM4	148
VM11AW	ZÁSUVKA SCHUKO + KS + KRYT 2P+E 16 A 250V ~ 2M	116	DM41	OBĽŽNIKOVÁ KRABICA DO STENY PM4-65	148
VM20AW	ZÁSUVKA EURO + KS 2P 10 A 250V ~ 1M	116	DM70	OBĽŽNIKOVÁ KRABICA DO STENY PM7	149
KM11AW	ZÁSUVKA TV KONCOVÁ 1 dB 1M	116	DM71	OBĽŽNIKOVÁ KRABICA DO STENY PM7-65	149
KM35AW	ADAPTÉR KS 1M	116	DM72	OBĽŽNIKOVÁ KRABICA DO STENY PM72-65	149
OS20AW	RÁMIK SOFT 2M	117	DM80	ROZPERA PRE KRABICU PM	149
OS24AW	RÁMIK SOFT 2 x 2M	117	DM33	OCHRANNÝ KRYT PM3	150
OS26AW	RÁMIK SOFT 3 x 2M	117	DM34	KRYT KRABICE DEKORATÍVNY PM3	150
OS30AW	RÁMIK SOFT 3M	117	DM43	OCHRANNÝ KRYT PM4	150
OS40AW	RÁMIK SOFT 4M	117	DM44	KRYT KRABICE DEKORATÍVNY PM4	150
OS70AW	RÁMIK SOFT 7M	117	DM73	OCHRANNÝ KRYT PM7	150
RÁMIKY PURE OP			DM74	KRYT KRABICE DEKORATÍVNY PM7	150
OP20-	RÁMIK PURE 2M	120	DM75	KRYT KRABICE DEKORATÍVNY PM72	151
OP24-	RÁMIK PURE 2x2M	120	HM30	OVÁLNA KRABICA - DUTÁ PRIEČKA VM3	152
OP26-	RÁMIK PURE 3x2M	120	HM40	OVÁLNA KRABICA - DUTÁ PRIEČKA VM4	152
OP28-	RÁMIK PURE 4x2M	120	HM70	OVÁLNA KRABICA - DUTÁ PRIEČKA VM7	152
OP30-	RÁMIK PURE 3M	121	HM72	OBĽŽNIKOVÁ KRABICA - DUTÁ PRIEČKA VM72	152
OP40-	RÁMIK PURE 4M	121	BM30	OBĽŽNIKOVÁ KRABICA - BETÓN BM3	153
OP70-	RÁMIK PURE 7M	121	BM40	OBĽŽNIKOVÁ KRABICA - BETÓN BM4	153
OP13-	RÁMIK PURE 1/3M	121	BM70	OBĽŽNIKOVÁ KRABICA - BETÓN BM7	153
OP23-	RÁMIK PURE 2/3M	121	BM80	UPEVŇOVACÍ PRVOK NA KRABICU BM	153
RÁMIKY LINE OL			BM82	DIŠTANČNÝ PROFIL NA KRABICE BM	153
OL20-	RÁMIK LINE 2M	124	SPOJOVACIE KRABICE		
OL24-	RÁMIK LINE 2x2M	124	DW10	ROZVODNÁ KRABICA OKRÚHLA DO STENY DSM78	156
OL26-	RÁMIK LINE 3x2M	124	HW10	ROZVODNÁ KRABICA OKRÚHLA - DUTÁ PRIEČKA SM78x45	156
OL28-	RÁMIK LINE 4x2M	124	DE23	KRYT KRABICE DEKORATÍVNY SM78	156
OL29-	RÁMIK LINE 5x2M	124	DE24	OCHRANNÝ KRYT KRABICE 78	156
OL30-	RÁMIK LINE 3M	125	HW20	ROZVODNÁ KRABICA ŠTVORCOVÁ DO STENY SM105x105	156
OL40-	RÁMIK LINE 4M	125	ELEKTROINŠTALAČNÝ MATERIÁL		
OL70-	RÁMIK LINE 7M	125	UW10-	JEDNORADOVÉ SVORKOVNICE ZATVORENÁ PC 2 x 2,5 mm ² 10P	158
OL10-	RÁMIK LINE 1/2M	125	UW11-	JEDNORADOVÉ SVORKOVNICE ZATVORENÁ PC 2 x 4 mm ² 10P	158
OL13-	RÁMIK LINE 1/3M	125	UW12-	JEDNORADOVÉ SVORKOVNICE ZATVORENÁ PC 2 x 6 mm ² 10P	158
OL23-	RÁMIK LINE 2/3M	125	UW15-	JEDNORADOVÉ SVORKOVNICE PA 2 x 2,5 mm ² 12P	158
RÁMIKY SOFT OS			UW16-	JEDNORADOVÉ SVORKOVNICE PA 2 x 4 mm ² 12P	158
OS20-	RÁMIK SOFT 2M	128	UW17-	JEDNORADOVÉ SVORKOVNICE PA 2 x 6 mm ² 12P	158
OS24-	RÁMIK SOFT 2 x 2M	128	UW29-	DVOJRADOVÉ SVORKOVNICE PP 1.0-4.0 mm ² 12P	158
OS26-	RÁMIK SOFT 3 x 2M	128	UW30-	DVOJRADOVÉ SVORKOVNICE PP 1.5-6.0 mm ² 12P	158
OS28-	RÁMIK SOFT 4 x 2M	128	UW31-	DVOJRADOVÉ SVORKOVNICE PP 2.5-10 mm ² 12P	158
OS30-	RÁMIK SOFT 3M	129	UW32-	DVOJRADOVÉ SVORKOVNICE PP 4.0-16 mm ² 12P	158
OS40-	RÁMIK SOFT 4M	129	UW25-	DVOJRADOVÉ SVORKOVNICE PA 1.0-4.0 mm ² 12P	159
OS70-	RÁMIK SOFT 7M	129	UW26-	DVOJRADOVÉ SVORKOVNICE PA 1.5-6.0 mm ² 12P	159
OS72-	RÁMIK SOFT 2 x 7M	129	UW27-	DVOJRADOVÉ SVORKOVNICE PA 2.5-10 mm ² 12P	159
OS10-	RÁMIK SOFT 1/2M	129	UW28-	DVOJRADOVÉ SVORKOVNICE PA 4.0-16 mm ² 12P	159
OS13-	RÁMIK SOFT 1/3M	129	UW40-	BEZSKRUTKOVÉ SVORKY PA 1,5 mm ² 3P	159
OS23-	RÁMIK SOFT 2/3M	129	UW41-	BEZSKRUTKOVÉ SVORKY PA 1,5 mm ² 5P	159
MONTÁŽNE RÁMY NM			UW42-	BEZSKRUTKOVÉ SVORKY PA 1,5 mm ² 8P	159
NM20	MONTÁŽNY RÁM S ROZPERKAMI 2M	134	UW45-	BEZSKRUTKOVÁ SVORKA PA 2,5 mm ² 3P	159
NM21	MONTÁŽNY RÁM BEZ SKRUTIEK 2M	134	UW46-	BEZSKRUTKOVÁ SVORKA PA 2,5 mm ² 4P	159
NM24	MONTÁŽNY KOVOVÝ RÁM S ROZPERKAMI 2M	134	UW47-	BEZSKRUTKOVÁ SVORKA PA 2,5 mm ² 5P	159
NM25	MONTÁŽNY KOVOVÝ RÁM BEZ SKRUTIEK 2M	134	UW50-	BEZSKRUTKOVÁ SVORKA PA 2,5 mm ² 2/1P	159
NM30	MONTÁŽNY RÁM SO SKRUTKAMI 3M	135			
NM40	MONTÁŽNY RÁM SO SKRUTKAMI 4M	135			
NM70	MONTÁŽNY RÁM SO SKRUTKAMI 7M	135			
NM72	MONTÁŽNY RÁM SO SKRUTKAMI 2 x 7M	135			
NM10	MONTÁŽNY RÁM S ROZPERKAMI 1/2M	136			
NM11	MONTÁŽNY RÁM BEZ SKRUTIEK 1/2M	136			
NM23	MONTÁŽNY RÁM S ROZPERKAMI 2/3M	136			
NM32	MONTÁŽNY RÁM SO SKRUTKAMI 2/3M	136			

distribúcia

kód	popis výrobku	strana
KRABICE CUBO IP20 AC		
AC11-	KRABICA NO CUBO S KRYTOM ZADNEJ STRANY IP20 1M	162
AC21-	KRABICA NO CUBO S KRYTOM ZADNEJ STRANY IP20 2M	162
AC41-	KRABICA NO CUBO S KRYTOM ZADNEJ STRANY IP20 4M	162
AC61-	KRABICA NO CUBO S KRYTOM ZADNEJ STRANY IP20 6M	162
KRABICE CUBO IP55 AQ		
AQ20-	KRABICA NO CUBO IP55 2M	163
AQ22-	KRABICA NO CUBO IP55 2x2M	163
AQ30-	KRABICA NO CUBO IP55 3M	163
AQ31-	KRABICA PO CUBO IP55 3M	163
AQ21	KRABICA PO CUBO IP55 2M	164
INŠTALAČNÝ SYSTÉM, HLINÍKOVÝ MA		
RT10	ADAPTÉR MA 92	165
RT12-	RÁMIK MA 92 2/3M	165
RT14-	RÁMIK MA 92 4M	165
RT17-	RÁMIK MA 92 7M	165
RT20-	ZÁKLADNÝ PROFIL MA 130x65	166
RT21-	ZÁKLADNÝ PROFIL MA 165x65	166
RT25-	PREDNÝ KRYT MA 92	166
RT30	PRIEHRADKA MA 43	166
RT31	PRIEHRADKA MA 43 AL	166
RT32	PRIEHRADKA MA 43 AL DVOJITÁ	166
RT35-	KONCOVÝ PRVOK MA 130x65	167
RT36-	KONCOVÝ PRVOK MA 165x65	167
RT38	SÚPRAVA SPOJOVACÍ PRVOKV MA 65	167
RT40-	UNIVERZÁLNY ROH MA 130x65	167
RT41-	UNIVERZÁLNY ROH MA 165x65	167
RT42	UZEMŇOVACIA SVORKA MA 2x A6.3	167
RT43-	PRVOK V TVARE "L" MA 130x65	168
RT44-	PRVOK V TVARE "L" MA 165x65	168
RT45-	ROZDELOVACÍ PRVOK V TVARE "T" MA 130x65	168
RT46-	ROZDELOVACÍ PRVOK V TVARE "T" MA 165x65	168
RT50-	UPEVŇOVACIA ZÁKLADŇA MA JEDNODUCHÁ 130x65	169
RT51-	UPEVŇOVACIA ZÁKLADŇA MA DVOJITÁ 130x65	169
RT52-	STĽPIK MA 130x65x500	169
RT53-	STĽPIK MA DVOJITÝ 130x130x500	169
PODLAHOVÉ KRABICE MT		
RB30	PODLAHOVÁ KRABICA MT 7 H = 53mm	171
RB40	PODLAHOVÁ KRABICA MT 7 H = 88mm	171
RB31	PODLAHOVÁ KRABICA MT 7 H = 53mm	171
RB41	PODLAHOVÁ KRABICA MT 7 H = 88mm	171
RB33	PODLAHOVÁ KRABICA MT 14 H = 53mm	171
RB43	PODLAHOVÁ KRABICA MT 14 H = 88mm	171
RB34	PODLAHOVÁ KRABICA MT 14 H = 53mm	172
RB44	PODLAHOVÁ KRABICA MT 14 H = 88mm	172
RB36	PODLAHOVÁ KRABICA MT 21 H = 53mm	172
RB46	PODLAHOVÁ KRABICA MT 21 H = 88mm	172
RB37	PODLAHOVÁ KRABICA MT 21 H = 53mm	172
RB47	PODLAHOVÁ KRABICA MT 21 H = 88mm	172
ROZVODNÉ SKRINKY MO		
RB10	ADAPTÉR NA DIN LIŠTU 35 mm 1M	173
RB11	ADAPTÉR NA DIN LIŠTU 35 mm 2M	173
RB20	ROZVODNÁ SKRINKA MO 12 + 2	174
RB21	ROZVODNÁ SKRINKA MO 24 + 4	174
RB22	ROZVODNÁ SKRINKA MO 36 + 6	174
RB23	ROZVODNÁ SKRINKA MO 48 + 8	174

ekonomik

kód	popis výrobku	strana
VYPÍNAČE SE		
SE10	SPÍNAČ JEDNOPÓLOVÝ 10 AX 250 V ~	188
SE11	TLAČIDLO JEDNOPÓLOVÉ 10 A 250 V ~	188
SE22	SPÍNAČ DVOJPOLOVÝ 16AX 250V ~	188
SE50	SPÍNAČ SÉRIOVÝ 10 AX 250 V ~	188
SE51	TLAČIDLO SÉRIOVÉ 10 A 250 V ~	189
SE52	ŽALÚZIOVÝ SPÍNAČ 10AX 250V ~	189
SE53	ŽALÚZIOVÉ TLAČIDLO 10 A 250 V ~	189
SE60	STRIEDAVÝ PREPÍNAČ 10 AX 250 V ~	189
SE63	STRIEDAVÝ PREPÍNAČ DVOJITÝ 10 AX 250 V ~	189
SE70	KRÍŽOVÝ PREPÍNAČ 10 AX 250 V ~	189
SE10-	SPÍNAČ JEDNOPÓLOVÝ 10 AX 250 V ~	190
SE10-IN	SPÍNAČ JEDNOPÓLOVÝ 10 AX 250 V ~ IN	190
SE11-	TLAČIDLO JEDNOPÓLOVÉ 10 A 250 V ~	190
SE11-TI50	TLAČIDLO JEDNOPÓLOVÉ 10 A 250 V ~ TI 50	190
SE11-TI51	TLAČIDLO JEDNOPÓLOVÉ 10 A 250 V ~ TI 51	190
SE11-IL	TLAČIDLO JEDNOPÓLOVÉ 10 A 250 V ~ IL	190
SE22-IN03	SPÍNAČ DVOJPOLOVÝ 16 AX 250 V ~ IN 03	190
SE50-	SPÍNAČ SÉRIOVÝ 10 AX 250 V ~	191
SE51-	TLAČIDLO SÉRIOVÉ 10 A 250 V ~	191
SE52-NT09	ŽALÚZIOVÝ SPÍNAČ 10 AX 250 V ~ NT 09	191
SE53-NT09	ŽALÚZIOVÉ TLAČIDLO 10 A 250 V ~ NT 09	191
SE60-	STRIEDAVÝ PREPÍNAČ 10 AX 250 V ~	191
SE63-	STRIEDAVÝ PREPÍNAČ DVOJITÝ 10 AX 250 V ~	191
SE70-	KRÍŽOVÝ PREPÍNAČ 10 AX 250 V ~	191
OSVETLENIE TE		
TE10-	KRYT TLAČIDLA	192
TE10-IN	KRYT TLAČIDLA S INDIKÁTOROM	192
TE13-IL	KRYT TLAČIDLA S POPISNÝM ŠTÍTKOM	192
TE11-	KRYT DVOJITÉHO TLAČIDLA	192
INDIKÁCIA IA		
IA10-	TLAJIVKA 230 V ~ 0,34 W	193
IA20-	LED DIÓDA 230 V AC/DC 0,40 W	193
IA21-	LED DIÓDA 24 V AC/DC 0,20 W	193
IA22-	LED DIÓDA 12 V AC/DC 0,10 W	193
ZÁSUVKY VE		
VE10-XO	ZÁSUVKA SCHUKO 2P+E 16 A 250 V ~ XO	196
VE11-XO	ZÁSUVKA SCHUKO + KRYT 2P+E 16 A 250 V ~ XO	196
VE12-XO	ZÁSUVKA SCHUKO 2P+E 16 A 250 V ~ BV XO	196
VE13-XO	ZÁSUVKA SCHUKO + KRYT 2P+E 16 A 250 V ~ BV XO	196
VE10-	ZÁSUVKA SCHUKO 2P+E 16 A 250 V ~	196
VE11-	ZÁSUVKA SCHUKO + KRYT 2P+E 16 A 250 V ~	196
VE12-	ZÁSUVKA SCHUKO 2P+E 16A 250V ~ BV	196
VE13-	ZÁSUVKA SCHUKO + KRYT 2P+E 16 A 250 V ~ BV	196
VE40-XO	FRANCÚZSKA ZÁSUVKA 2P+E 16 A 250 V ~ XO	197
VE41-XO	FRANCÚZSKA ZÁSUVKA + KRYT 2P+E 16 A 250 V ~ XO	197
VE42-XO	FRANCÚZSKA ZÁSUVKA 2P+E 16 A 250 V ~ BV XO	197
VE43-XO	FRANCÚZSKA ZÁSUVKA + KRYT 2P+E 16 A 250 V ~ BV XO	197
VE40-	FRANCÚZSKA ZÁSUVKA 2P+E 16 A 250 V ~	197
VE41-	FRANCÚZSKA ZÁSUVKA + KRYT 2P+E 16 A 250 V ~	197
VE42-	FRANCÚZSKA ZÁSUVKA 2P+E 16 A 250 V ~ BV	197
VE43-	FRANCÚZSKA ZÁSUVKA + KRYT 2P+E 16 A 250 V ~ BV	197
VE16-	ZÁSUVKA SCHUKO DVOJITÁ 2P+E 16 A 250 V ~	198
VE46-	FRANCÚZSKA ZÁSUVKA DVOJITÁ 2P+E 16 A 250 V ~	198
VE30-	ZÁSUVKA 2P 16 A 250 V ~	198
KOMUNIKÁCIE KE		
KE11	ZÁSUVKA TV-R KONCOVÁ 1 dB	199
KE12	ZÁSUVKA TV-R PRIEBEŽNÁ 10 dB	199
KE16	ZÁSUVKA SAT-TV-R KONCOVÁ 3 dB	199
KE36	ZÁSUVKA TEL KS RJ11 6/4	199
KE37	ZÁSUVKA KAT. 5e KS RJ45 8/8	200
KE40	ZÁSUVKA KAT. 6s KS RJ45 8/8 SLIM	200
KE38	ZÁSUVKA TEL KS DVOJITÁ 2 x RJ11 6/4	200
KE39	ZÁSUVKA KAT. 5e KS DVOJITÁ 2 x RJ45 8/8	200
KE41	ZÁSUVKA KAT. 6s KS DVOJITÁ 2 x RJ45 8/8 SLIM	200
KE45	ADAPTÉR KS SAMOSTATNÝ	200
KE46	ADAPTÉR KS DVOJITÝ	201
KE47	ADAPTÉR PD DVOJITÝ	201
KE10-	ZÁSUVKA TV ZÁKLADNÁ 0dB	202
KE11-	ZÁSUVKA TV-R KONCOVÁ 1 dB	202
KE12-	ZÁSUVKA TV-R PRIEBEŽNÁ 10 dB	202
KE16-	ZÁSUVKA SAT-TV-R KONCOVÁ 3 dB	202
KE22-	AUDIO ZÁSUVKA 2xRCA	202
KE23-	ZÁSUVKA AUDIO REPRODUKTOROVÁ	202
KE36-	ZÁSUVKA TEL KS RJ11 6/4	202
KE37-	ZÁSUVKA KAT. 5e KS RJ45 8/8	203
KE40-	ZÁSUVKA KAT. 6s KS RJ45 8/8 SLIM	203
KE38-	ZÁSUVKA TEL KS DVOJITÁ 2 x RJ11 6/4	203
KE39-	ZÁSUVKA KAT. 5e KS DVOJITÁ 2 x RJ45 8/8	203
KE41-	ZÁSUVKA KAT. 6s KS DVOJITÁ 2 x RJ45 8/8 SLIM	203
KE35-	ZÁSUVKA TEL LT RJ11 6/4	203

kód	popis výrobku	strana
KRYTY PA		
PE10-	KRYT TV-R 2P/3P	204
PE20-	KRYT KS SAMOSTATNÝ	204
PE21-	KRYT KS DVOJITÝ	204
PE30-	KRYT TAE/TDO	204
PE32-	KRYT IR SPÍNAČ	204
ELEKTRONIKA EE		
EE15	STMIEVAČ ROTAČNÝ STRIEDAVÝ RL 400 W	205
EE16	STMIEVAČ ROTAČNÝ STRIEDAVÝ RLC 400 W	205
EE19	STMIEVAČ ROTAČNÝ STRIEDAVÝ LED 100 W	206
EE15-	STMIEVAČ ROTAČNÝ STRIEDAVÝ RL 400 W	206
EE16-	STMIEVAČ ROTAČNÝ STRIEDAVÝ RLC 400 W	207
EE19-	STMIEVAČ ROTAČNÝ STRIEDAVÝ LED 100 W	207
EE32-	IR SPÍNAČ 5 A 250 V ~	207
ELEKTRONICKÝ KRYT PE		
PE41-	KRYT NA STMIEVAČ Ø 6	209
PRÍSLUŠENSTVO AE		
AE10-	VÝPLŇ	210
AE20-	SPOJOVACIA KRABICA PÄŤPÓLOVÁ 3P+N+E 5 x 4 mm ²	210
AE30-	KRABICA PRE POVRCHOVÚ MONTÁŽ 1	210
AE31-	POVRCHOVÁ KRABICA PRE DVOJITÚ ZÁSUVKU EKONOMIK	210
AE50-	CHRÁNIČ STENY	211
AE51-	DETSKÁ OCHRANA KS	211
RÁMIKY OE		
OE10-	RÁMIK EKONOMIK 1	212
OE20-	RÁMIK EKONOMIK 2 HORIZONTÁLNY	212
OE21-	RÁMIK EKONOMIK 2 VERTIKÁLNY	212
OE30-	RÁMIK EKONOMIK 3 HORIZONTÁLNY	212
OE31-	RÁMIK EKONOMIK 3 VERTIKÁLNY	213
OE40-	RÁMIK EKONOMIK 4 HORIZONTÁLNY	213
OE41-	RÁMIK EKONOMIK 4 VERTIKÁLNY	213
OE50-	RÁMIK EKONOMIK 5 HORIZONTÁLNY	213
OE90-	DEKORATÍVNE RÁMIKY COLOUR	214
fontana		
kód	popis výrobku	strana
SPÍNAČE SF		
SF10-	SPÍNAČ JEDNOPÓLOVÝ IP44 10 AX 250 V ~	218
SF10-TI	SPÍNAČ JEDNOPÓLOVÝ IP44 10 AX 250 V ~ __ TI	218
SF11-TI	TLAČIDLO JEDNOPÓLOVÉ IP44 10 A 250 V ~ __ TI	218
SF20-	SPÍNAČ DVOJPÓLOVÝ IP44 10 AX 250 V ~	218
SF50-	SPÍNAČ SÉRIOVÝ IP44 10 AX 250 V ~	219
SF51-	TLAČIDLO SÉRIOVÉ IP44 10 A 250 V ~	219
SF60-	STRIEDAVÝ PREPÍNAČ IP44 10 AX 250 V ~	219
SF60-TI	STRIEDAVÝ PREPÍNAČ IP44 10 AX 250 V ~ __ TI	219
SF63-	STRIEDAVÝ PREPÍNAČ DVOJITÝ IP44 10 AX 250 V ~	219
SF70-	KRÍŽOVÝ PREPÍNAČ IP44 10 AX 250 V ~	219
ZÁSUVKY VF		
VF10-	ZÁSUVKA SCHUKO + KRYT IP44 2P+E 16 A 250 V ~	220
VF12-	ZÁSUVKA SCHUKO + KRYT IP44 2P+E 16 A 250 V ~ BV	220
SETI CF		
CF10-	SÚPRAVA ZÁSUVIEK SCHUKO DVOJITÁ HORIZONTÁLNA IP44 2 x 2x2P+E 16 A 250 V ~	221
CF11-	SÚPRAVA ZÁSUVIEK SCHUKO DVOJITÁ VERTIKÁLNA IP44 2 x 2x2P+E 16 A 250 V ~	221
CF12-	ZÁSUVKA SCH + DVOJPÓLOVÝ SPÍNAČ HORIZONTÁLNY IP44 16 A + 10 AX 250 V ~	221
CF13-	ZÁSUVKA SCH + SÚPRAVA DVOJPÓLOVÝCH SPÍNAČOV VERTIKÁLNA IP44 16 A + 10 AX 250 V ~	222
CF14-	SÚPRAVA ZÁSUVIEK SCHUKO DVOJITÁ HORIZONTÁLNA IP44 2x 2P+E 16 A 250 V ~ BV	222
CF15-	SÚPRAVA ZÁSUVIEK SCHUKO DVOJITÁ VERTIKÁLNA IP44 2x 2P+E 16 A 250 V ~ BV	222
CF16-	ZÁSUVKA + SÚPRAVA SPÍNAČOV + DVOJPÓLOVÉ HORIZONTÁLNE IP44 16 A + 10 AX 250 V ~ BV	222
CF17-	ZÁSUVKA + SÚPRAVA SPÍNAČOV + DVOJPÓLOVÉ VERTIKÁLNE IP44 16 A + 10 AX 250 V ~ BV	222
PRÍSLUŠENSTVO AF		
AF10-	ROZVODNÁ KRABICA IP44 RN01	223
AF20-	ROZVODNÁ KRABICA IP55 ND01	223

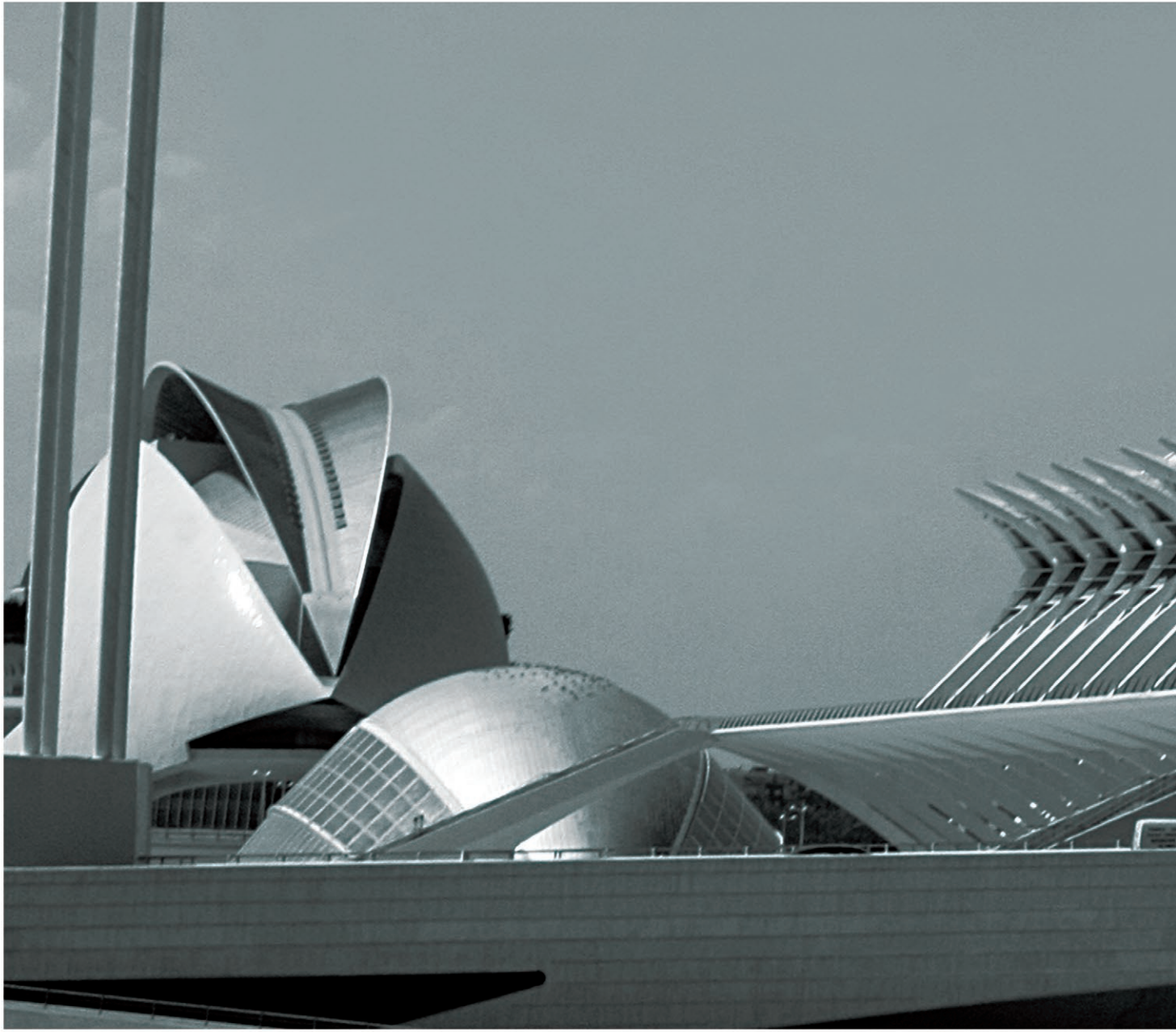

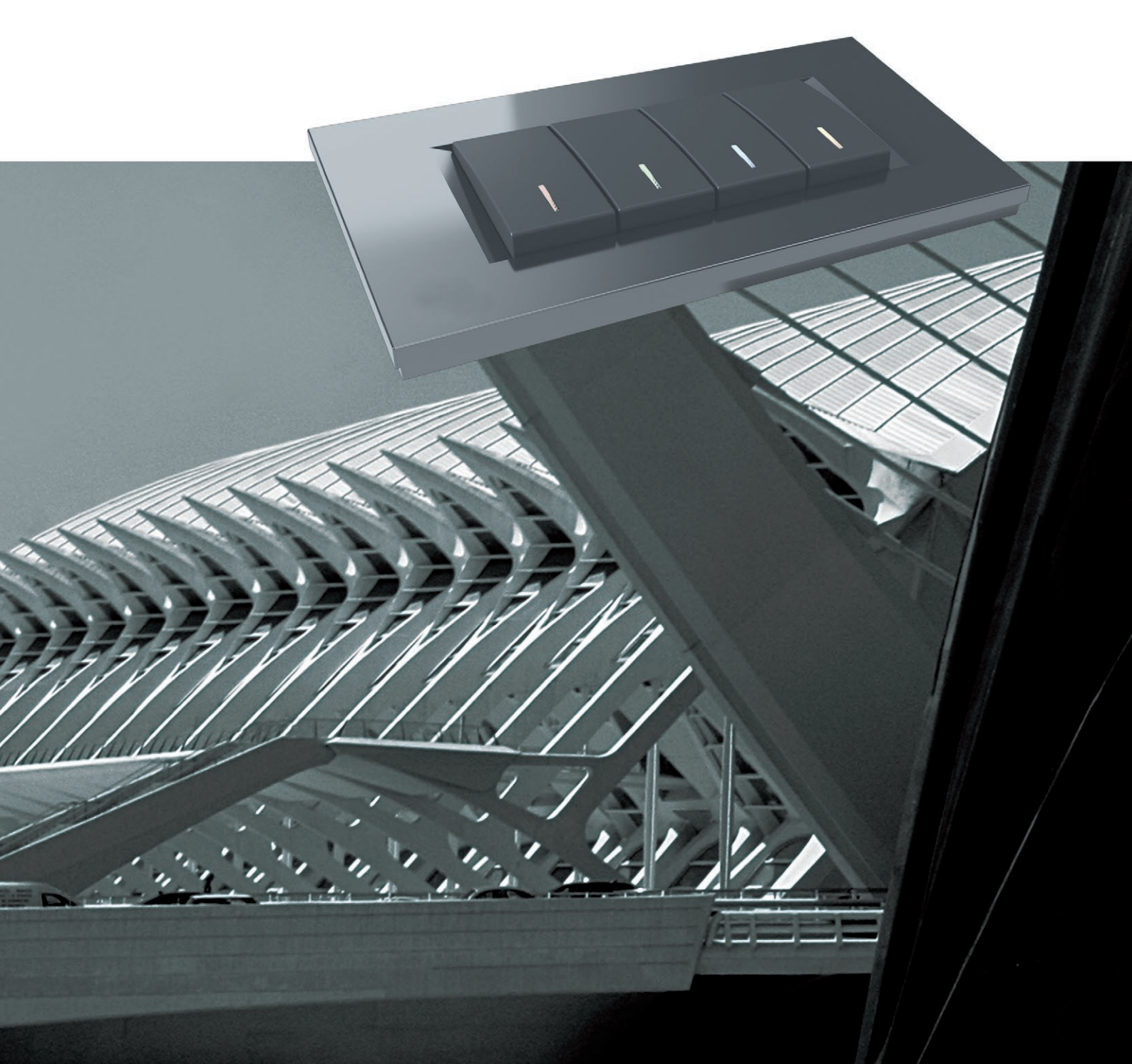

TEM

TEM ČATEŽ d.o.o.
Čatež 13, 8212 VELIKA LOKA
SLOVENIJA
tem@tem.si
www.tem.si
T +386(0)7 348 99 00



SK